

PAR WEST



EVERYTHING YOU NEED FOR EVERY JOB ON TURF.
GOLF COURSE | IRRIGATION | LANDSCAPE | SPORTS TURF | CUSTOM SIGNAGE



WWW.PARWEST.COM

THE PAR WEST STANDARD.

WHO WE ARE



ORDER YOUR WAY.

We understand that chatbots and automated prompts are everywhere, making it harder to connect or place orders. No matter your role in turf management, we go above and beyond to ensure you get what you need—quickly, easily, and with a personal touch.



ORDER ONLINE AT
WWW.PARWEST.COM



CALL OUR
SALES DEPT DIRECTLY



CONTACT YOUR LOCAL
PAR WEST REP



EMAIL OUR
SALES DEPT

Personalized Customer Service Support
Hassle-Free Ordering
National Account Special Pricing Programs |
Net 30 Term Invoicing With Approval
Fast Shipping With In-Stock Products

REGISTER YOUR ONLINE ACCOUNT TODAY!

WWW.PARWEST.COM/MY-ACCOUNT-PAR-WEST/



@PARWESTTURF



@PARWESTTURF



@PARWESTTURF



@WEAREPARWESTTURF



@PARWESTTURF

FOLLOW US ON SOCIAL!

Connect with us on social media for the latest products, promotions, and specials only for our friends!



At Par West, we understand what it takes to keep our customer's turf on point. We have all you need to help them master their turf and every job that comes with it. With this mindset, we strive to provide our customers with unparalleled support in every aspect of managing their turf and related needs.

OUR CORE VALUES

PURPOSE – We are driven toward bettering the lives of those we interact with by the service, products, and experience provided to them.

ACTION – We take action! If we see something in need of fixing or to be done, we jump in and EXECUTE!

RESILIENT – We always adjust and re-frame to overcome any obstacle. We learn from our mistakes and strive to improve!

WILLINGNESS – We go the extra mile with the intent of leaving every situation better than we found it.

EFFECTIVE – We improve and analyze so we can best serve our customers and each other. We focus on bringing the best outcome every time!

SERVICE – We are of service to each other and who we interact with always! We lead with a selfless mindset and a HELP MORE focus.

TRUSTWORTHY – We do what we say we will do. NO exceptions!

NATIONAL SALES REP MAP

Give us a call, and we'll connect you with a local rep who's ready to provide personalized service and expert support to meet all your course maintenance needs.

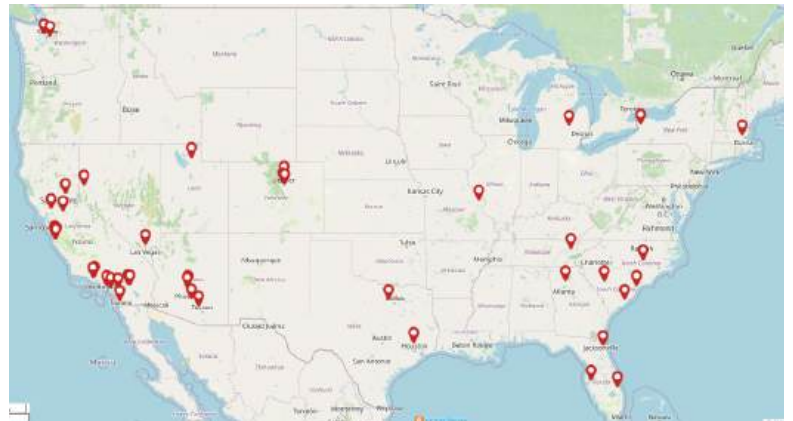











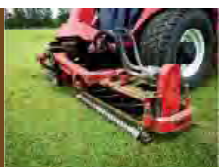



TABLE OF CONTENTS

SIGN SHOP 4-30		GREEN ACCESSORIES 80-99		IRRIGATION & WATERING 125-157	
DRIVING RANGE & PRACTICE AREA 31-51		BUNKER MAINTENANCE 100-104		AQUATIC MAINTENANCE 158-163	
CLUBHOUSE FURNISHINGS 52-59		COURSE & YARDAGE MARKINGS 105-109		TURF & AGRONOMY 164-195	
TOURNAMENT & GOLF SHOP SUPPLIES 60-62		TRAFFIC CONTROL 110-113		POWER EQUIPMENT 196-200	
STARTER AREA & PRACTICE GREEN 63-66		GOLF CART PARTS & ACCESSORIES 114-115		EQUIPMENT PARTS 201-229	
TEE PRODUCTS 67-79		SAFETY PRODUCTS 116-124		MAINTENANCE SHOP SUPPLIES 230-235	

NATIONAL PARTNERS



PREFERRED NATIONAL DEALER



2025 NEW PRODUCTS



CUSTOM TEE SIGNS PAGES 8-11



SHOWCASE TEE MARKERS PAGE 69



LOGO TARGETS PAGES 46-47



LONG DRIVE MARKER PAGE 62



PERMA-CORE CLOSEST TO THE PIN PAGE 62



CUSTOM EASELS PAGE 28-29



YARDAGE TARGETS PAGE 46-47



HOLE CUTTER GUIDE PAGE 93



HIO XACT HOLE CUTTER PAGE 90



ACCUFORM ACCUTRIM PAGE 154



SG PRO HOLE CUTTER PAGE 90



DELUXE METAL CUP SETTER PAGE 93



PINPOINT CUP CHANGER PAGE 92



SPOTON TURF MOISTURE METER PAGE 166



POWER GULP PUMP PAGE 155



EFORCE BATTERY POWERED EQUIPMENT PAGES 199-200



LITHIUM ION BATTERY CHARGING STORAGE CABINET PAGE 234



KUJO X45 WATERPROOF BOOT PAGE 122

YOUR ULTIMATE SUPPLIER FOR CUSTOM COURSE MESSAGING.

- Custom signs for golf courses, corporate and special events
- High-quality fabric and printing hardware
- Hassle-free ordering process
- FREE art design proofs within one business day
- FREE logo vector conversion with order
- FASTEST completion and shipping time in the golf industry
- **Create eye-catching custom signs with our Perma-Core brand**

Par West is here to help you customize and create eye-catching and attractive signage, grab the attention and gain significant traction with new course customers. From graphics to text to the most minute of details, Par West is here to help you take control of all your golf course messaging and signage

Perma-Core laminate plastic products are made from high quality American 1/2 inch laminate material. We have multiple color options to choose from, resin fill for special letter coloring, and engraved or lexan logo options available. Nobody beats our turn around time on our Perma-Core plastic products!!

PERMA-CORE LAMINATE PRODUCTS



CUSTOM MESSAGE SIGNS



FAIRWAY SIGNS



TEE MARKERS



TEE SIGNS



RANGE YARDAGE TARGETS



FAIRWAY YARDAGE TARGETS



DRIVING RANGE YARDAGE EASELS



DIVOT RANGE SIGNS



DRIVING RANGE DIVIDERS



ENTER/EXIT SIGNS

CAST BRONZE & ALUMINUM PRODUCTS



TEE SIGNS



QUICK CHANGE SIGNS



YARDAGE MARKERS



TEE MARKERS

ALUMINUM GOLF COURSE SIGNS



COURSE SIGNS



GOLF COURSE TRAFFIC SIGNS

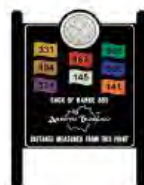

DRIVING RANGE SIGNS



SAFETY SIGNS



PREMIUM CURVED ALUMINUM SIGNS



6 PAR WEST SIGN SHOP



Pricing is subject to change.

DESIGN YOUR OWN PW SERIES CUSTOM ALUMINUM SIGN

Step 1 - Choose Your Colors



GREEN & WHITE



GREEN & GOLD



BLACK & GOLD



WHITE & GREEN

These Are Our Common Colors, But You Can Choose Any Color You Want! See **Next Page** for color options.

STEP 2 - CHOOSE YOUR SIZE

Pick from Our In-Stock Sizes - Or You Can Order Any Custom Size Or Shape

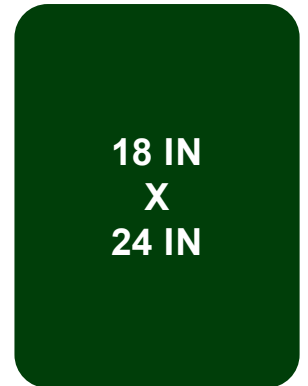
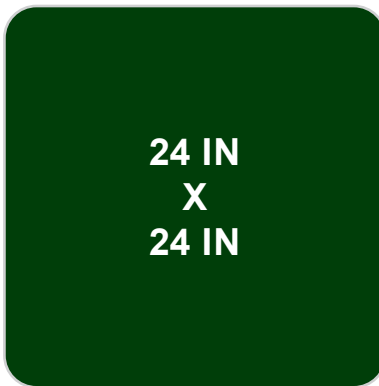
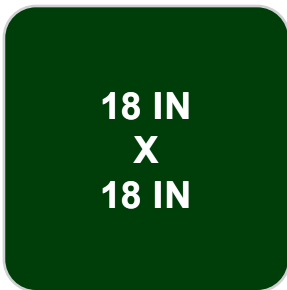

PREMIUM CURVED SERIES

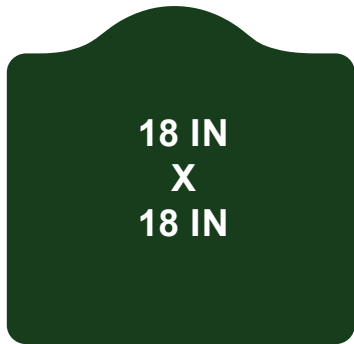

PREMIUM CURVED SERIES

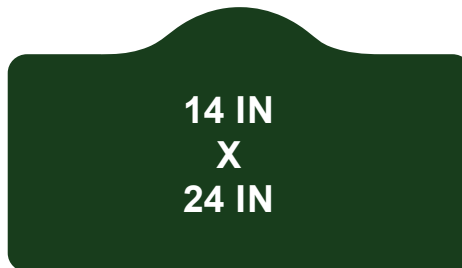

STEP 3 - ADD YOUR DETAILS

Tell Us Your Message - Add Your Logo and a Border - Customize to Your Needs

PART NUMBER	DESCRIPTION
PWALS1212-C	12 X 12 PW SERIES CUSTOM SIGN
PWALS1218-C	12 X 18 PW SERIES CUSTOM SIGN
PWALS1818-C	18 X 18 PW SERIES CUSTOM SIGN
PWALS1824-C	18 X 24 PW SERIES CUSTOM SIGN
PWALS2424-C	24 X 24 PW SERIES CUSTOM SIGN
PWALS1424C-CUS	14 X 24 PREMIUM CURVED SIGN
PWALS1818C-CUS	18 X 18 PREMIUM CURVED SIGN

We'll customize any of our signs or make any message you need. Reach out to us for a quote and FREE proof within 1 business day at no charge!



"PRICES MAY INCREASE WITH MORE DIFFICULT LOGOS OR SPECIAL FEATURES

PERMA CORE ENGRAVED PLASTIC SIGNS

STEP 1 - CHOOSE YOUR COLOR

Choose Between Our 12 Color Options



- 1 GREEN WITH WHITE LETTERS
- 2 WHITE WITH GREEN LETTERS
- 3 BLACK WITH WHITE LETTERS
- 4 BLUE WITH WHITE LETTERS
- 5 RED WITH WHITE LETTERS
- 6 WHITE WITH RED LETTERS
- 7 WHITE WITH BLACK LETTERS
- 8 BROWN WITH WHITE LETTERS
- 9 YELLOW WITH BLACK LETTERS
- 10 TAN WITH GREEN LETTERS
- 11 TAN WITH BROWN LETTERS
- 12 BROWN WITH TAN LETTERS

STEP 2 - CHOOSE YOUR SHAPE AND SIZE

Choose from Our Common Sizes Or We Can Create Any Custom Shape Or Size!

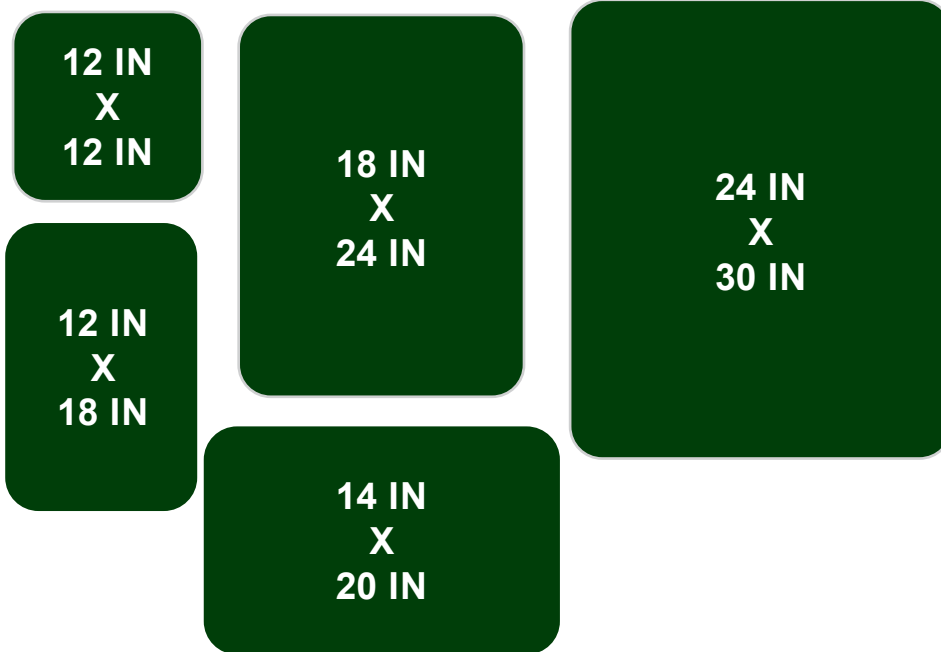

PREMIUM CURVED SERIES

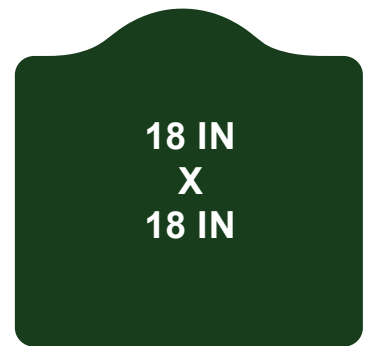

PREMIUM CURVED SERIES



STEP 3 - ADD YOUR FINAL TOUCHES AND WE WILL START THE ARTWORK FOR YOU

PART NUMBER	DESCRIPTION
PWPC1212-C	12 X 12 PERMA CORE CUSTOM SIGN
PWPC1218-C	12 X 18 PERMA CORE CUSTOM SIGN
PWPC1420-C	14 X 20 PERMA CORE CUSTOM SIGN
PWPC1824-C	18 X 24 PERMA CORE CUSTOM SIGN
PWPC2430-C	24 X 30 PERMA CORE CUSTOM SIGN
PWPC1424C-C	14 X 24 PREMIUM CURVED CUSTOM SIGN
PWPC1818C-C	18 X 18 PREMIUM CURVED CUSTOM SIGN

We'll customize any of our signs or make any message you need. Reach out to us for a quote and FREE proof within 1 business day at no charge!



Logos, color fill and special shapes will increase the cost of a sign. We will always give you a full quote and production proof before starting any job.

*All signs are 1/2" thick as standard. 3/4" thick available upon request.

Pricing is subject to change.

CAST BRONZE AND ALUMINUM TEE SIGNS
CALL FOR PRICING - DISCOUNTED PRICING FOR FULL COURSE SIGN ORDERS

STEP 1 - CHOOSE YOUR SERIES & SIZE



SIGNATURE SERIES

- Discounted pricing for full course sign orders (18 holes)
- Includes logo
- Choose post and background colors

- PC-TS-1218-BZ 12" X 18" BRONZE
- PC-TS-1218-AL 12" X 18" ALUMINUM
- PC-TS-1420-BZ 14" X 20" BRONZE
- PC-TS-1420-AL 14" X 20" ALUMINUM
- PC-TS-1824-BZ 18" X 24" BRONZE
- PC-TS-1824-AL 18" X 24" ALUMINUM



CLASSIC SERIES

- Discounted pricing for full course sign orders (18 holes)
- Includes logo
- Choose post and background colors
- Includes yardages

- PC-TC-1218-BZ 12" X 18" BRONZE
- PC-TC-1218-AL 12" X 18" ALUMINUM
- PC-TC-1420-BZ 14" X 20" BRONZE
- PC-TC-1420-AL 14" X 20" ALUMINUM
- PC-TC-1824-BZ 18" X 24" BRONZE
- PC-TC-1824-AL 18" X 24" ALUMINUM



IMPERIAL SERIES
Hole Layout

- Discounted pricing for full course sign orders (18 holes)
- Includes logo
- Choose post and background colors
- Includes hole layout & yardages

- PC-TI-1218-BZ 12" X 18" BRONZE
- PC-TI-1218-AL 12" X 18" ALUMINUM
- PC-TI-1420-BZ 14" X 20" BRONZE
- PC-TI-1420-AL 14" X 20" ALUMINUM
- PC-TI-1824-BZ 18" X 24" BRONZE
- PC-TI-1824-AL 18" X 24" ALUMINUM

- A picture perfect hole starts with the right tee set-up. What do your tees say about your golf course?
- Cast aluminum or bronze tee signs are a classically elegant, and surprisingly affordable, way to designate your tees.
- Choose the style and features you want and our artists will create renderings quickly and at no charge.

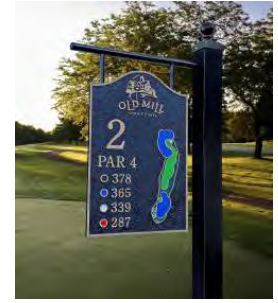

STEP 2 - CHOOSE YOUR SIGN SHAPE



STEP 3 - CHOOSE YOUR POST & CAP
8 Foot Aluminum Posts



STEP 4 - CHOOSE YOUR MOUNTING STYLE

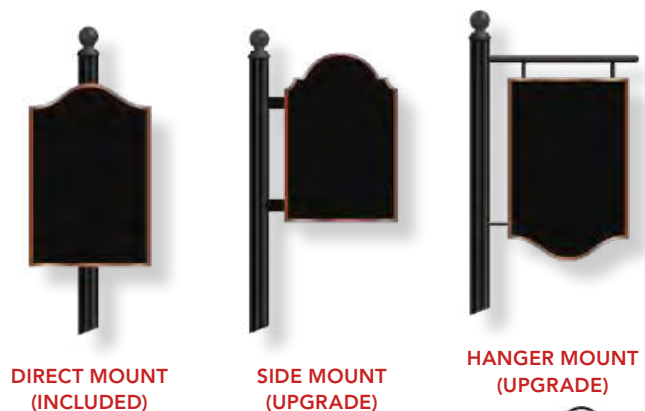

FUSIONCAST TEE SIGNS

FusionCast®

ENGINEERED METAL CASTING TECHNOLOGY

HIGH METAL CONCENTRATION

LOW METAL CONCENTRATION



What Is Fusioncast?

Fusion Cast proprietary casting methods mix high density urethane with ionized metals, where a high concentration of metal is forced to the face where the metal is of value and visible.



YARDAGE SIGNS

- Includes tee signs with logo, hole number, par and yardages
- Aluminum posts (3 inch)
- Post caps (3 inch)
- Direct mount included - other mounts are upgrades
- Choose post and background colors

PART NUMBER	SIGN TYPE & SIZE
FC-TC-1218-BZ	12" X 18" BRONZE
FC-TC-1218-AL	12" X 18" ALUMINUM
FC-TC-1420-BZ	14" X 20" BRONZE
FC-TC-1420-AL	14" x 20" ALUMINUM

Call for quote - available in 9 hole and 18 hole packages.

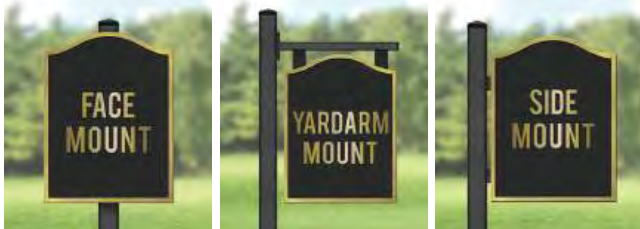

MOUNT AND COLOR OPTIONS



BASIC SIGNS

- Includes tee signs with logo, hole number and par
- Aluminum posts (3 inch)
- Post caps (3 inch)
- Direct mount included - other mounts are upgrades
- Choose post and background colors

Call for quote - available in 9 hole packages.



PART NUMBER	SIGN TYPE & SIZE
FC-TS-1218-BZ	12" X 18" BRONZE
FC-TS-1218-AL	12" X 18" ALUMINUM
FC-TS-1420-BZ	14" X 20" BRONZE
FC-TS-1420-AL	14" X 20" ALUMINUM

HOLE LAYOUT SIGNS

- Includes tee signs with graphic hole layout, logo, hole number, par and 4 yardages
- Aluminum posts (3 inch)
- Post caps (3 inch)
- Direct mount included - other mounts are upgrades
- Choose post and background colors

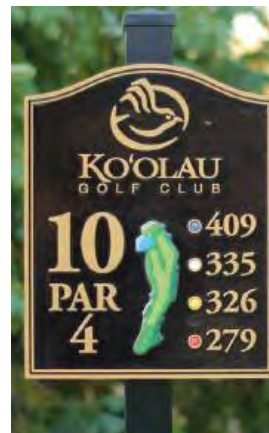

Call for quote - available in 9 hole and 18 hole packages.

PART NUMBER	SIGN TYPE & SIZE
FC-TI-1218-BZ	12" X 18" BRONZE
FC-TI-1218-AL	12" X 18" ALUMINUM
FC-TI-1420-BZ	14" X 20" BRONZE
FC-TI-1420-AL	14" x 20" ALUMINUM

PERMA CORE PLASTIC TEE SIGNS

STEP 1 - CHOOSE YOUR SERIES & SIZE

SIGNATURE SERIES



- Discounted pricing for full course sign orders (18 holes)
- Includes logo

CLASSIC SERIES



- Discounted pricing for full course sign orders (18 holes)
- Includes logo
- Includes yardages with color fill dots

IMPERIAL SERIES

Hole Layout



- Discounted pricing for full course sign orders (18 holes) Includes logo
- Includes yardages with color fill dots
- Includes color fill hole layout



PWPC1218-S- 12" X 18"

PWPC1420-S- 14" X 20"

PWPC1824-S- 18" X 24"

PWPC1218-CS- 12" X 18"

PWPC1420-CS- 14" X 20"

PWPC1824-CS- 18" X 24"

PWPC1218-I- 12" X 18"

PWPC1420-I- 14" X 20"

PWPC1824-I- 18" X 24"

STEP 2 - CHOOSE YOUR SIGN SHAPE



STEP 3 - CHOOSE YOUR SIGN COLOR



STEP 4 - CHOOSE YOUR BORDER & LETTER COLOR FILL OPTIONS FOR CLASSIC & IMPERIAL SERIES



STEP 5 - LOGO & HOLE LAYOUT



LEXAN LOGO



ENGRAVED LOGO



RESIN COLOR FILL

SEND US YOUR SCORECARD HOLE LAYOUT FOR IMPERIAL SERIES SIGNS

Free Art Design - Free Proofs

- Send us your scorecard and logo
- Our in house art team will help you design the perfect tee sign - including various options at no charge



STEP 6 - CHOOSE YOUR SIGN MOUNT



8 FT U-CHANNEL SIGN POST

PWPOSTUCG-8

RECYCLED PLASTIC MOUNTING POST OPTIONS

5, 6, 7, Or 8 Feet Options

- Black, White, Brown, and Green Options Available.
- 4 inch x 4 inch material
- Great for Perma-core tee signs

RCPPPOST4460- 5' POST

RCPPPOST4472- 6' POST

RCPPPOST4484- 7' POST

RCPPPOST4496- 8' POST



12 PAR WEST SIGN SHOP

ALUMINUM DIGITAL PRINT TEE SIGNS

STEP 1 - CHOOSE YOUR SERIES & SIZE

SIGNATURE SERIES



- Discounted pricing for full course sign orders (18 holes)
- Includes logo

PWALS1218-S- 12" X 18"
 PWALS1420-S- 14" X 20"
 PWALS1824-S- 18" X 24"

CLASSIC SERIES



- Discounted pricing for full course sign orders (18 holes)
- Includes logo
- Includes yardages and color dots

PWALS1218-CS- 12" X 18"
 PWALS1420-CS- 14" X 20"
 PWALS1824-CS- 18" X 24"

IMPERIAL SERIES

Hole Layout



- Discounted pricing for full course sign orders (18 holes)
- Includes logo
- Includes yardages with color dots
- Includes color hole layout

PWALS1218-I- 12" X 18"
 PWALS1420-I- 14" X 20"
 PWALS1824-I- 18" X 24"

STEP 2- CHOOSE YOUR SIGN SHAPE



STEP 3- CHOOSE YOUR PRINT COLOR

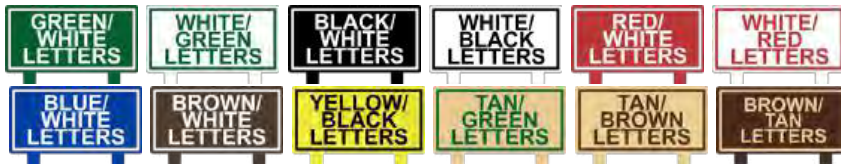

STEP 5 - SEND US YOUR LOGO!

STEP 6 - HOLE LAYOUT

SEND US YOUR SCORECARD HOLE LAYOUT FOR IMPERIAL SERIES SIGNS
 Free Art Design - Free Proofs



- Send us your scorecard and logo
- Our in house art team will help you design the perfect tee sign - including various options at no charge

STEP 5 - CHOOSE YOUR SIGN MOUNT



8 FT U-CHANNEL SIGN POST

PWPOSTUCG-8



RECYCLED PLASTIC MOUNTING POST OPTIONS
 5, 6, 7, Or 8 Feet Options

- Black, White, Brown, and Green Options Available.
- 4 inch x 4 inch material
- Great for aluminum tee signs

RCPOST4460- 5' POST
 RCPOST4472- 6' POST
 RCPOST4484- 7' POST
 RCPOST4496- 8' POST

Pricing is subject to change.

CAST BRONZE OR ALUMINUM COURSE DIRECTIONAL SIGNS

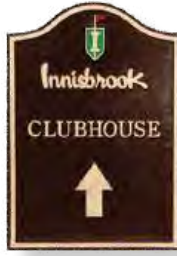

- PCDS-1012-BZ 10" X 12" BRONZE SIGN
- PCDS-1012-AL 10" X 12" ALUMINUM SIGN
- PCDS-1014-BZ 10" X 14" BRONZE SIGN
- PCDS-1014-AL 10" X 14" ALUMINUM SIGN
- PCDS-1218-BZ 12" X 18" BRONZE SIGN
- PCDS-1218-AL 12" X 18" ALUMINUM SIGN
- PCDS-1420-BZ 14" X 20" BRONZE SIGN
- PCDS-1420-AL 14" X 20" ALUMINUM SIGN
- PCPOST-SQ-33-06 6 FOOT ALUMINUM POST

- Cast metal signage is a tasteful and elegant way to communicate course direction with your patrons.
- Combine your logo with one of our many shapes and sizes available.
- Use up to 30 characters per sign (minimum letter size of 1")

ALUMINUM SIGN POST

- 6 feet tall
- 3 inch x 3 inch material
- Durable and weather resistant powder coated Aluminum
- Works with plastic signs or Aluminum signs
- Top ball cap sold separately

- PCPOST-SM-0306 3 INCH X 3 INCH BLACK SQUARE POST
- PCFN-1033 3 INCH DECORATIVE BALL CAP FINIAL

ADDITIONAL SIGN POST CAPS



- 3" BALL CAP
- 3" FLAT CAP
- 4" BALL CAP- UPGRADE
- 4" FLAT CAP- UPGRADE



CAST BRONZE & ALUMINUM QUICK CHANGE SIGNS

Cast Bronze Or Cast Aluminum

- Quick change signs can be used to update cart rules, hole locations, yardages or Green speeds.
- Brass plates can be used to update just about any information you want to communicate to your golfers
- Plates sold separately
- Let our in house artists help you design the perfect sign for you

CALL FOR PRICING

- PCCR-1214-BZ 12" X 14" BRONZE SIGN
- PCCR-1214-AL 12" X 14" ALUMINUM SIGN
- PCCR-1420-BZ 14" X 20" BRONZE SIGN
- PCCR-1420-AL 14" X 20" ALUMINUM SIGN
- PCCR-1824-BZ 18" X 24" BRONZE SIGN
- PCCR-1824-AL 18" X 24" ALUMINUM SIGN
- PCPOST-SQ-33-06 6 FOOT ALUMINUM POST



PERMA-CORE QUICK CHANGE SIGNS

We also make Perma-core Quick Change Signs out of our signature laminate plastic. Call us to find more information or get a quote!



*See page 26 for more post options.

12X6 PERMA-CORE PLASTIC SMALL FAIRWAY SIGNS

Single Piece With Double Steel Spikes



- 12" x 6" PLASTIC sign won't fade, warp or fail
- Full 1/2" thick material with stainless steel spikes
- Engraved letters - color-fill available
- Single sided message
- Choose from our stock colors or special order other colors
- Custom Message Available!

SIGN COLOR OPTION KEY



- PWPC4 SINGLE-SIDED
- PWPC4D DOUBLE-SIDED
- PWPC5A ARROW (REVERSIBLE)

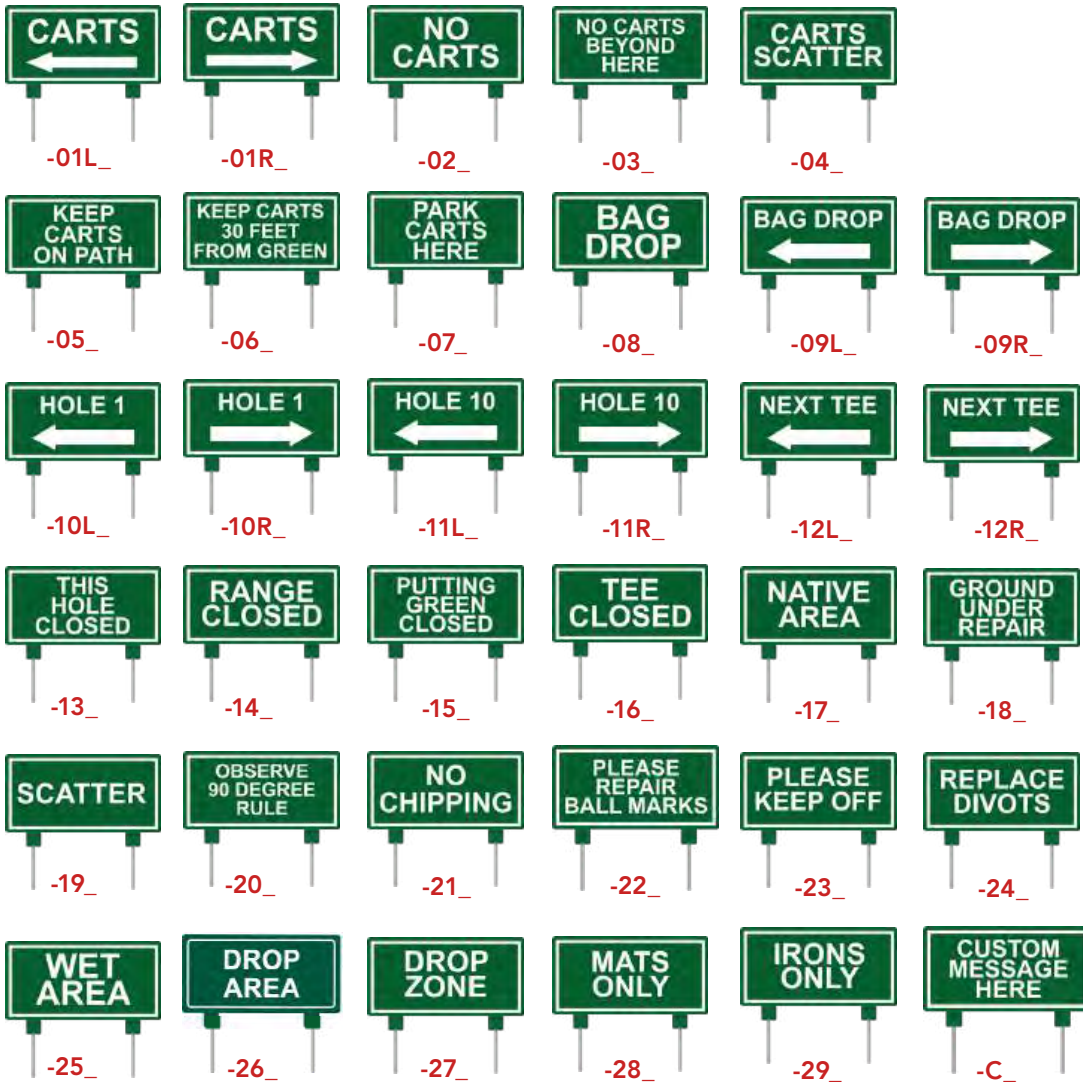

Pricing is subject to change.

PERMA-CORE SINGLE SPIKE PLASTIC FAIRWAY SIGNS

Comes in 1/2" and 1/4" Options



- 10" x 5" plastic sign won't fade, is extremely durable and weather resistant
- Single sided messages
- Cart with reversible arrow is double-sided
- Choose from our stock colors or special order other colors
- Custom Message Available!

SIGN COLOR OPTION KEY



* Our 1/4" signs are a more economical option, but not as durable as the 1/2" option.

- PWPC5 1/2" SINGLE-SIDED
- PWPC5D 1/2" DOUBLE-SIDED
- PWPC5E *1/4" SINGLE-SIDED
- PWPC5DE *1/4" DOUBLE-SIDED

 -01L_	 -01R_	 -02_	 -03_	 -04_	
 -05_	 -06_	 -07_	 -08_	 -09L_	 -09R_
 -10L_	 -10R_	 -11L_	 -11R_	 -12L_	 -12R_
 -13_	 -14_	 -15_	 -16_	 -17_	 -18_
 -19_	 -20_	 -21_	 -22_	 -23_	 -24_
 -25_	 -26_	 -27_	 -28_	 -29_	 -C_



15X9 PERMA-CORE PLASTIC LARGE FAIRWAY SIGNS

Single Piece With Double Steel Spikes



- 15" x 9" plastic sign won't fade, warp or fail
- Full 1/2" thick material with stainless steel spikes
- Engraved letters - color-fill available
- Single sided message
- Choose from our stock colors or special order other colors
- Custom Message Available!

PWPC3 SINGLE-SIDED

PWPC3D DOUBLE-SIDED

SIGN COLOR OPTION KEY

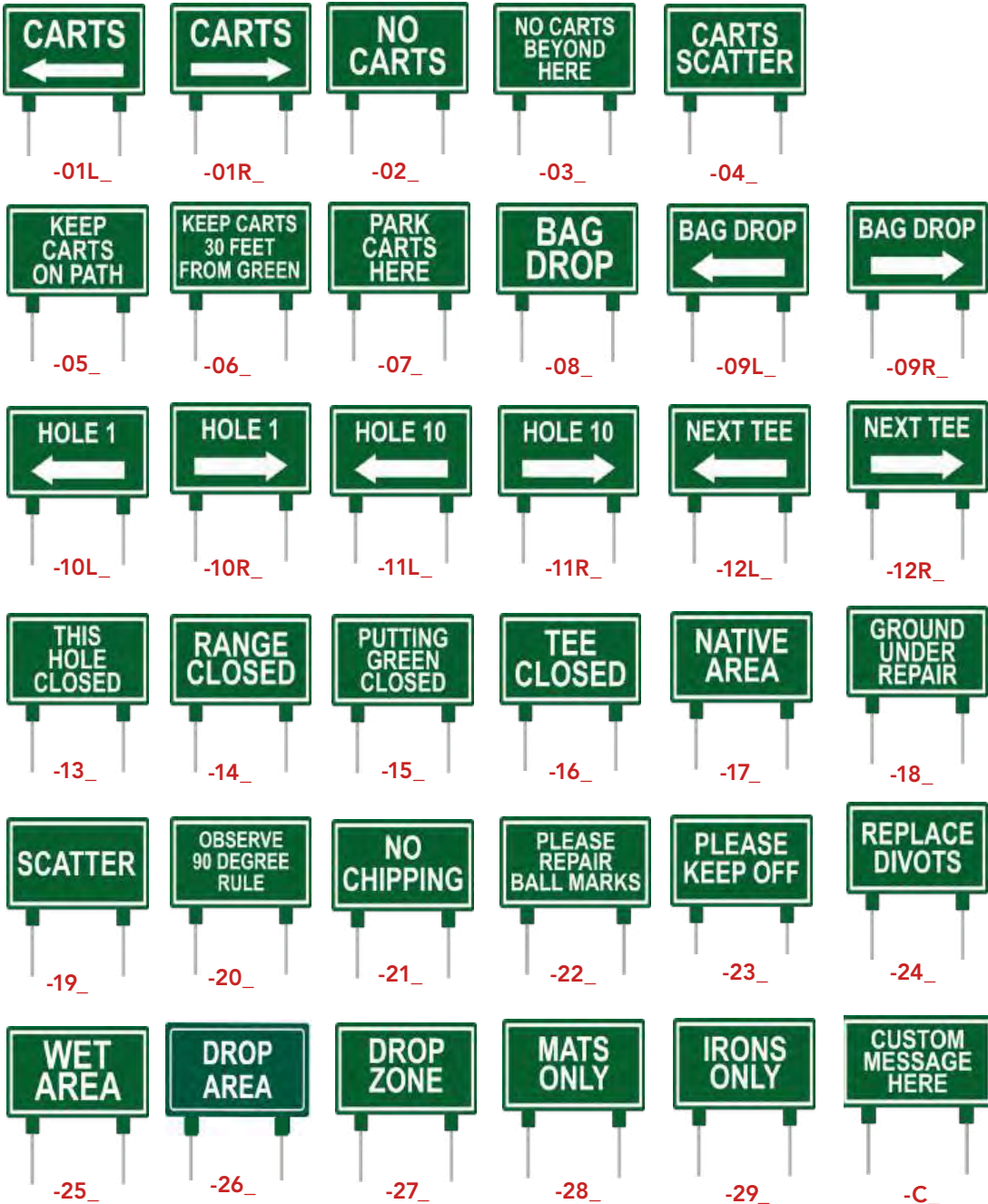

Pricing is subject to change.

PERMA CORE DELUXE OVAL FAIRWAY HANDLE SIGNS



- 12" x 9" Oval sign w/ handle
- 1/2" thick
- Engraved letters
- Choose stock colors or we can special order any color

SIGN COLOR OPTION KEY



- PWPC2** SINGLE-SIDED - DOUBLE SPIKE
- PWPC2D** DOUBLE-SIDED - DOUBLE SPIKE
- PWPC2-S12** SINGLE-SIDED - 12-INCH STAKE
- PWPC2D-S12** DOUBLE-SIDED - 12-INCH STAKE
- PWPC2-S18** SINGLE-SIDED - 18-INCH STAKE
- PWPC2D-S18** DOUBLE-SIDED - 18-INCH STAKE

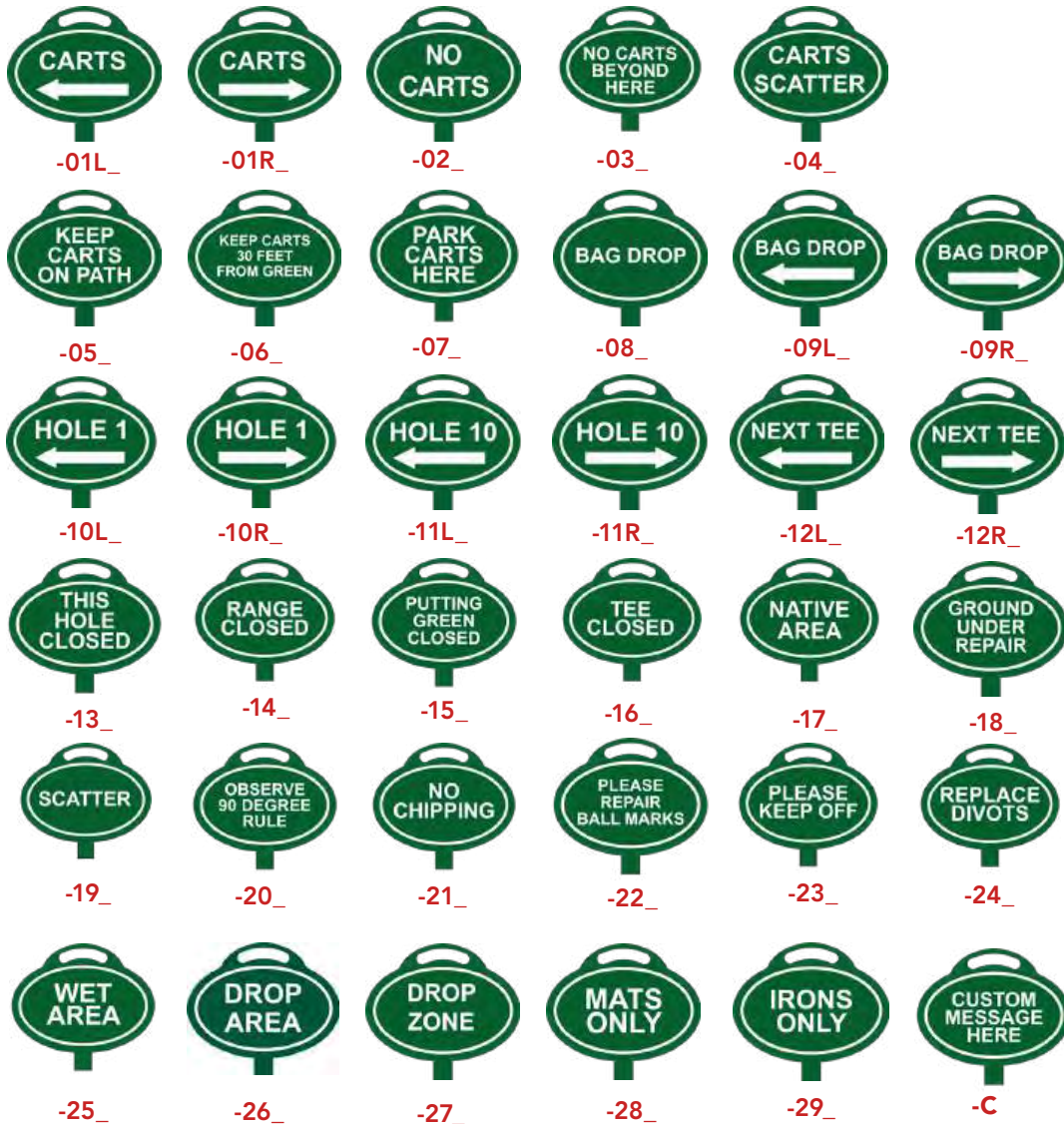

PORTABLE RECYCLED LUMBER SIGN POSTS

12" & 18" Options



- PWRPS-400-30** GREEN
- PWRPS-800-30** BLACK
- PWRPS-200-30** WHITE

ALUMINUM DOUBLE SPIKE FAIRWAY SIGNS



- Always custom messages - you choose it, we make it - no art fees or extra charges
- Great looking sign - less expensive than plastic
- Don't get stuck with limited messages in plastic signs
- Choose between two color schemes
- Always double-sided messages - no extra charge
- Fairway sign is 9" wide x 4.5" tall
- Arrow sign is 15" long x 4" tall

SIGN COLOR OPTION KEY



PWALS4D DOUBLE-SIDED

PWALS4-A ARROW (REVERSIBLE)

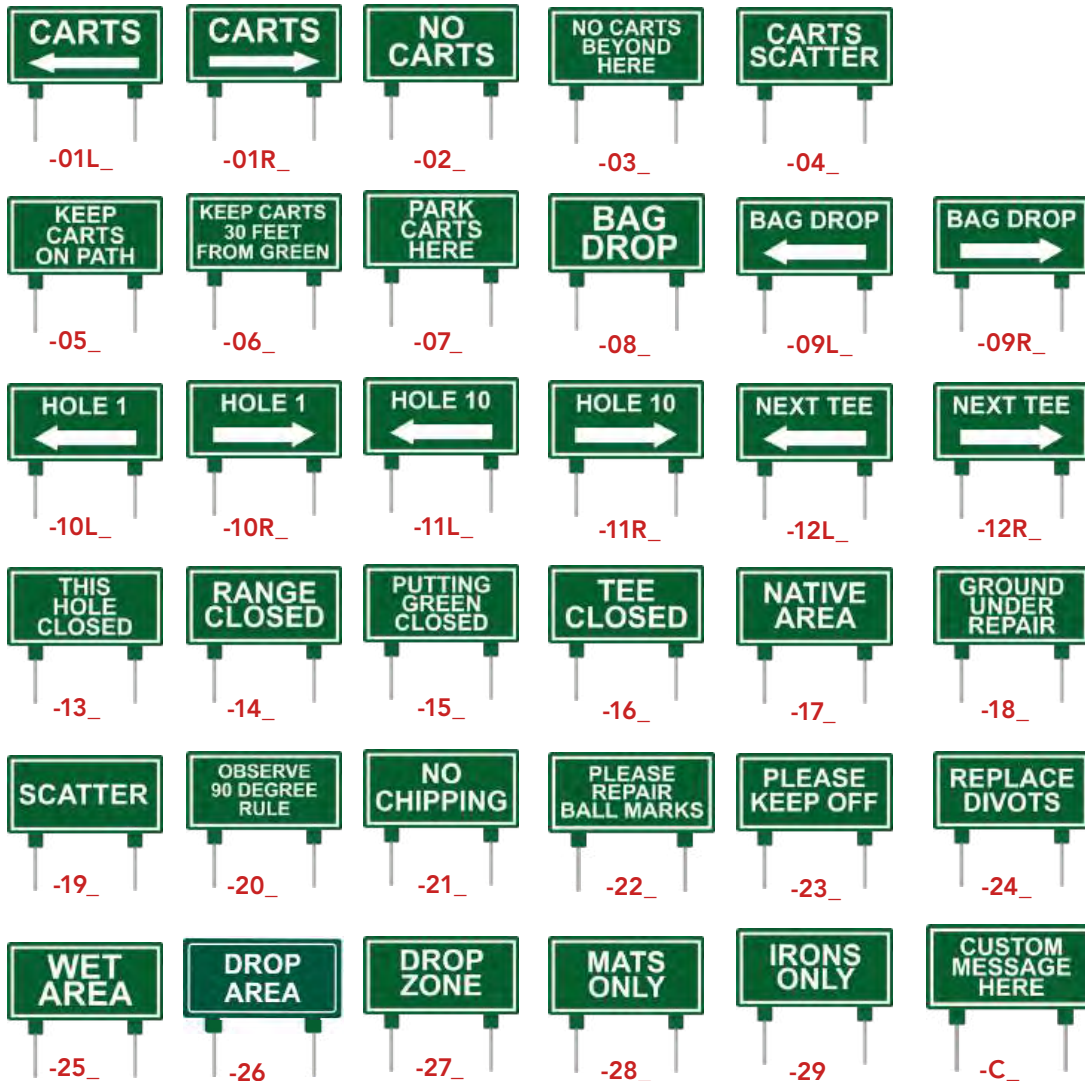

Pricing is subject to change.

DURA-FLEX PLASTIC SIGNS



- Indestructible course communications.
- Our exclusive Dura-Flex Signs survive years of punishment from wayward carts and whatever else your course can dish out.
- Thick, flexible and maintenance-free material with raised 3D lettering and a molded-in continuous spike.
- A wide selection of standard messages and colors are available.
- 10 1/2 in. x 5 1/2 in. (27 cm x 14 cm) (not including spike)

SIGN COLOR OPTION KEY



PAR5610-

PAR5620-

PAR5630-



- | | |
|-----------------------------|----------------------------|
| 01 GROUND UNDER REPAIR | 13 NO CHIPPING |
| 02 TEE AREA CLOSED | 14 NEXT TEE |
| 03 NO CARTS PAST HERE | 16 NO CARTS |
| 04 KEEP CARTS ON PATH | 17 < CARTS |
| 05 PLEASE RAKE BUNKERS | 18 CARTS > |
| 06 PLEASE REPAIR BALL MARKS | 19 < NEXT TEE |
| 07 DROP AREA | 20 NEXT TEE > |
| 08 WET AREA CARTS KEEP OFF | 21 PLEASE OBSERVE 90° RULE |
| 09 PLEASE REPLACE DIVOTS | 22 TROLLEYS > |
| 10 PLEASE KEEP OFF | 23 < TROLLEYS |
| 11 CARTS SCATTER | 24 NO TROLLEYS |
| 12 PUTTING GREEN CLOSED | 25 DROP ZONE |

WOOD DIRECTIONAL SIGNS



- Give your golf course a timeless, traditional look with our new hardwood signs
- Each sign is individually hand-oiled to maintain a rich, hardwood color
- Can be easily refurbished by applying teak oil
- Letters are routed and painted black
- Stainless steel spikes
- 10 3/8 in. x 5 3/8 in. x 3/4 in. (26 cm x 14 cm x 2 cm)

PAR5660 SINGLE-SIDED MESSAGES

PAR5660-50 CARTS > (DOUBLE-SIDED)

- | | |
|-----------------------------|----------------------------|
| 01 GROUND UNDER REPAIR | 13 NO CHIPPING |
| 02 TEE AREA CLOSED | 14 NEXT TEE |
| 03 NO CARTS PAST HERE | 16 NO CARTS |
| 04 KEEP CARTS ON PATH | 17 < CARTS |
| 05 PLEASE RAKE BUNKERS | 18 CARTS > (DOUBLE-SIDED) |
| 06 PLEASE REPAIR BALL MARKS | 19 < NEXT TEE |
| 07 DROP AREA | 20 NEXT TEE > |
| 08 WET AREA CARTS KEEP OFF | 21 PLEASE OBSERVE 90° RULE |
| 09 PLEASE REPLACE DIVOTS | 22 TROLLEYS > |
| 10 PLEASE KEEP OFF | 23 < TROLLEYS |
| 11 CARTS SCATTER | 24 NO TROLLEYS |
| 12 PUTTING GREEN CLOSED | 25 DROP ZONE |



PERMA CORE ENTER/EXIT SIGNS

OVAL ENTER/EXIT SIGNS

10" x 7" Sign on 18" Sign Post

PWPC-EN18- ENTER SIGN

PWPC-EX18- EXIT SIGN

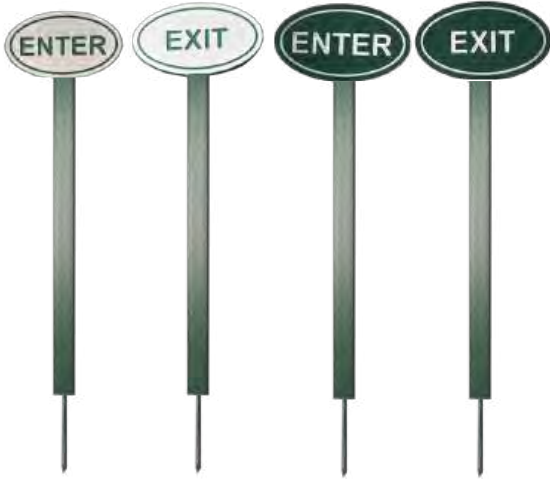

ENTER/EXIT SIGN COLOR OPTION KEY



PORTABLE RECYCLED LUMBER SIGN POSTS
18" Options

PWRPS-400-30 GREEN

PWRPS-800-30 BLACK

PWRPS-200-30 WHITE

Custom Stake Size Options Available!

VERTICAL ENTER/EXIT SIGNS

32" x 3.5"

PWPC-EN- ENTER SIGN

PWPC-EX- EXIT SIGN



ENTER/EXIT SIGN COLOR OPTION KEY



Don't need Enter/Exit Signs?
We can also customize our stakes with any message and color you need! Call us for more information!

ENTER/EXIT FLAGS

32" x 3.5"

PWTPF-EN TRAFFIC POST - ENTER

PWTPF-EX TRAFFIC POST - EXIT

PWTPF-C TRAFFIC POST W/ CUSTOM FLAG

PWRPS-800-12-YT 12" TRAFFIC CONTROL STAKE (CASE OF 25)

Custom options available.



Pricing is subject to change.

ALUMINUM SINGLE SPIKE FAIRWAY SIGNS



- 10" x 6" Aluminum sign
- 1/8" thick
- One-piece construction for greater durability
- Powder-coated finish
- Double sided message

SIGN COLOR OPTION KEY



-_ = ENTER LETTER IN FINAL SPOT WHITE/GREEN & BROWN/WHITE SIGNS COLOR OPTIONS

GCA7D-



12X12 PERMA-CORE COURSE INFORMATIONAL SIGNS

1/2" *1/4"

SIGN COLOR OPTION KEY

- PWPC1212-S IN-STOCK INFORMATIONAL SIGN (SEE BELOW)
- PWPC1212-1 CUSTOMIZED ONE COLOR
- PWPC1212-2 CUSTOMIZED TWO COLORS
- PWPC1212-3 CUSTOMIZED THREE COLORS



WE WAIVE ALL ART FEES TO SAVE YOU THE HASSLE OF TIME AND MONEY WITH CREATING YOUR CUSTOM SIGN MESSAGES!



PWPC1212-101-__



PWPC1212-121-__



PWPC1212-116-__



PWPC1212-112-__



PWPC1212-126-__



PWPC1212-103-__



PWPC1212-104-__



PWPC1212-114-2



* Our 1/4" signs are a more economical option, but not as durable as the 1/2" option.



PWPC1212-123-__



PWPC1212-109-__



PWPC1212-110-__



PWPC1212-125-__



PWPC1212-304-__



PWPC1212-301-__



PWPC1212-305-__



PWPC1212-119-__



PWPC1212-113-__



PWPC1212-111-__



PWPC1212-130-__



PWPC1212-C

PORTABLE RECYCLED LUMBER SIGN POSTS 30" Posts

- PWRPS-400-30 GREEN
- PWRPS-800-30 BLACK
- PWRPS-200-30 WHITE



RECYCLED PLASTIC MOUNTING POST OPTIONS 5, 6, 7, Or 8 Feet Options

- Black, White, Brown, and Green Options Available.
- 4 inch x 4 inch material
- Great for perma-core plastic signs



- RCPOST4460-__ 5' POST
- RCPOST4472-__ 6' POST
- RCPOST4484-__ 7' POST
- RCPOST4496-__ 8' POST

See other sign post options on page 26!

12X18 PERMA-CORE COURSE INFORMATIONAL SIGNS

- PWPC1218-5 IN-STOCK INFORMATIONAL SIGN (SEE BELOW)
- PWPC1218-1 CUSTOMIZED ONE COLOR
- PWPC1218-2 CUSTOMIZED TWO COLORS
- PWPC1218-3 CUSTOMIZED THREE COLORS

1/2" *1/4"

SIGN COLOR OPTION KEY



WE WAIVE ALL ART FEES TO SAVE YOU THE HASSLE OF TIME AND MONEY WITH CREATING YOUR CUSTOM SIGN MESSAGES!

* Our 1/4" signs are a more economical option, but not as durable as the 1/2" option.



PWPC1218-109-__



PWPC1218-105-__



PWALS1218-102-__



PWPC1218-303-__



PWPC1218-304-__



PWPC1218-C

PORTABLE RECYCLED LUMBER SIGN POSTS

30" Posts



- PWRPS-400-30 GREEN
- PWRPS-800-30 BLACK
- PWRPS-200-30 WHITE

RECYCLED PLASTIC MOUNTING POST OPTIONS

5, 6, 7, Or 8 Feet Options



- Black, White, Brown, and Green Options Available.
- 4 inch x 4 inch material
- Great for perma-core plastic signs

- RCPOST4460-__ 5' POST
- RCPOST4472-__ 6' POST
- RCPOST4484-__ 7' POST
- RCPOST4496-__ 8' POST



See other sign post options on page 26!

12X12 ALUMINUM COURSE INFORMATIONAL SIGNS

PWAL1212- IN-STOCK INFORMATIONAL SIGNS



PWALS1212-101



PWALS1212-121



PWALS1212-112



PWALS1212-113



PWALS1212-126



PWALS1212-102



PWALS1212-104

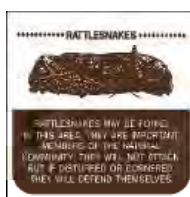

PWALS1212-103



PWALS1212-116



PWALS1212-114



PWALS1212-111



PWALS1212-109



PWALS1212-110



PWALS1212-123



PWALS1212-119



PWALS1212-108



PWALS1212-1310



PWALS1212-125



PWALS1212-207



PWALS1212-204



PWALS1212-124



PWALS1212-303

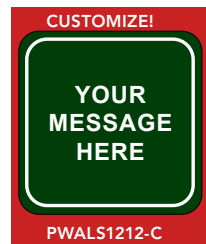

PWALS1212-C

PORTABLE STEEL SIGN POSTS



- Pre-drilled to hold our 12" x 12" signs or 12" x 18" signs

STD10400 40" TALL

STD10418 18" TALL

8 FT U-CHANNEL SIGN POST



PWPOSTUG-8

See other sign post options on page 26!

12X18 ALUMINUM INFORMATIONAL SIGNS

PWPC1218- IN-STOCK INFORMATIONAL SIGNS



PWALS1218-108-__



PWALS1218-101



PWALS1218-109-__



PORTABLE STEEL SIGN POSTS



PWALS1218-302



PWALS218-105



PWALS218-102



- Pre-drilled to hold our 12" x 12" signs or 12" x 18" signs
STD10400 40" TALL
STD10418 18" TALL



PWPC1218-303-__



PWPC1218-304-__

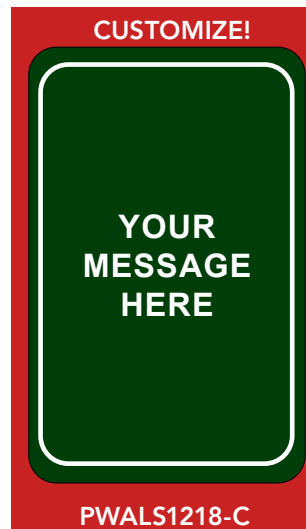

PWALS1218-C

8 FT U-CHANNEL SIGN POST



PWPOSTUCG-8

See other sign post options on page 26!





HAZARDOUS MATERIALS DIAMOND SIGNS

OSHA Compliant

- Complete kit available on a 12" x 12" Aluminum sign or as a vinyl decal kit
- Each kit comes with 3 of each number 0-4 and 1 of each word/symbol - oxy, alk, acid, W

PWALS1212-205 12" ALUMINUM SIGN KIT

PWVL-NUM NUMBER & SYMBOL KIT ONLY

MAINTENANCE SHOP SIGNS

Choose Aluminum Or Perma-Core Laminate Plastic

- PWPC1212-** 12X12 PERMA-CORE
- PWALS1212-** 12X12 ALUMINUM
- PWPC1218-** 12X18 PERMA-CORE
- PWALS1218-** 12X18 ALUMINUM

PERMA-CORE COLOR OPTION KEY



PART NUMBER

MATERIAL

MESSAGE

PWALS218-202	ALUMINUM	TURF MAINTENANCE FACILITY
PWPC1218-202-1	GREEN PLASTIC	TURF MAINTENANCE FACILITY
PWPC1218-202-2	WHITE PLASTIC	TURF MAINTENANCE FACILITY
PWALS1212-206	ALUMINUM	SUPERINTENDENTS OFFICE
PWPC1212-206-1	GREEN PLASTIC	SUPERINTENDENTS OFFICE
PWPC1212-206-2	WHITE PLASTIC	SUPERINTENDENTS OFFICE
PWALS1212-202	ALUMINUM	UNAUTHORIZED PERSONS
PWPC1212-202-1	GREEN PLASTIC	UNAUTHORIZED PERSONS
PWPC1212-202-2	WHITE PLASTIC	UNAUTHORIZED PERSONS
PWALS1218-201	ALUMINUM	PRIVATE PROPERTY
PWPC1218-201-1	GREEN PLASTIC	PRIVATE PROPERTY
PWPC1218-201-2	WHITE PLASTIC	PRIVATE PROPERTY
PWALS1218-203	ALUMINUM	REQUIRED SAFETY GEAR
PWALS1218-203-1	GREEN PLASTIC	REQUIRED SAFETY GEAR
PWALS1218-203-2	WHITE PLASTIC	REQUIRED SAFETY GEAR

PORTABLE STEEL SIGN POSTS

- Pre-drilled to hold our 12" x 12" signs or 12" x 18" signs

STD10400 40" TALL

STD10418 18" TALL

8 FT U-CHANNEL SIGN POST

- Pre-drilled to hold our 12" x 12" signs or 12" x 18" signs

PWPOSTUCG-8



Pricing is subject to change.

RECYCLED PLASTIC SIGN POSTS
5, 6, 7, or 8 Feet Options

- 5, 6, 7, or 8 Feet Options
- Black, White, Brown, and Green Options Available.
- Call for custom color.
- 4 inch x 4 inch material
- Durable and weather resistant - great for Perma-core plastic signs or Aluminum signs
- Decorative beveled top



BLACK WHITE BROWN GREEN



-BK -WH -BR -GR

- RCPOST4460-** 5' POST
- RCPOST4472-** 6' POST
- RCPOST4484-** 7' POST
- RCPOST4496-** 8' POST

ALUMINUM SIGN POSTS



- 6 feet tall
- 3 inch x 3 inch material
- Durable and weather resistant powder coated Aluminum
- Works with plastic signs or Aluminum signs
- Top ball cap sold separately

- PCPOST-SM-0306** 3 INCH X 3 INCH BLACK SQUARE POST
- PCFN-1033** 3 INCH DECORATIVE BALL CAP FINIAL

PORTABLE RECYCLED LUMBER SIGN POSTS

30" Posts



- Made right here in our facility with the highest quality recycled plastic material
- 30 inches tall and come with a 6 inch spike so you can move sign anywhere you need it
- Perfect fit for 12" x 12" or 12" x 18" signs
- Custom sizes available

- PWRPS-400-30** GREEN
- PWRPS-800-30** BLACK
- PWRPS-200-30** WHITE



PORTABLE STEEL SIGN POSTS

- Made of durable steel to move signs wherever needed
- Pre-drilled to hold our 12" x 12" signs or 12" x 18" signs

- STD10400** 40" TALL
- STD10418** 18" TALL



8 FT U-CHANNEL SIGN POST

- Green baked enamel u-channel posts resist corrosion.
- Tapered end easily drives into the ground.
- 3/8" Holes on 1" centers to easily attach signs.
- Meets mutcd standards.
- Pair with custom aluminum course signs. Sold separately.

PWPOSTUCG-8

28 PAR WEST SIGN SHOP

PERMA CORE IN GROUND ROUND YARDAGE MONUMENTS

Comes With Two Stainless Steel Spikes
6", 8", 11" & 15" Options

- PWPCRN-YARDAGE- SIZE-COLOR NUMBERED MONUMENT
- PWPCRN-C- SIZE-COLOR CUSTOM MONUMENT
- PWPCRN-P- SIZE-COLOR PLAIN MONUMENT

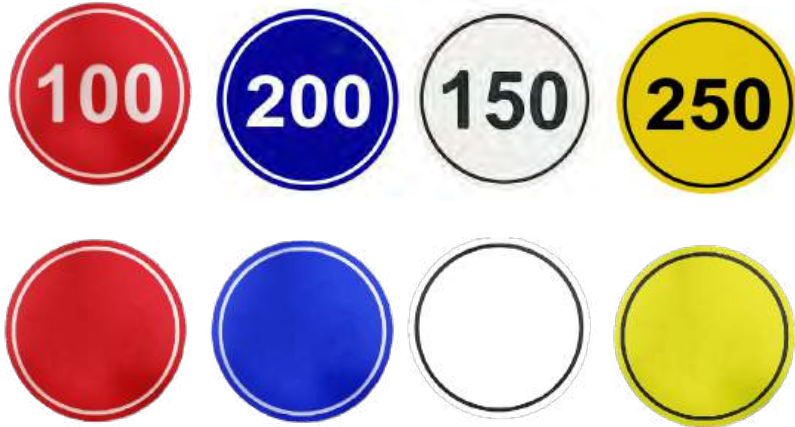

Call us for a quote for additional color options. Add logo to any marker above at additional cost.



PERMA-CORE COLOR OPTION KEY



PERMA CORE IN GROUND RECTANGLE YARDAGE MONUMENTS

Comes With Two Stainless Steel Spikes
8" X 12"

- PWPCRC-YARDAGE-COLOR NUMBERED MONUMENT
- PWPCRC-C-COLOR CUSTOM MONUMENT
- PWPCRC-P-COLOR PLAIN MONUMENT

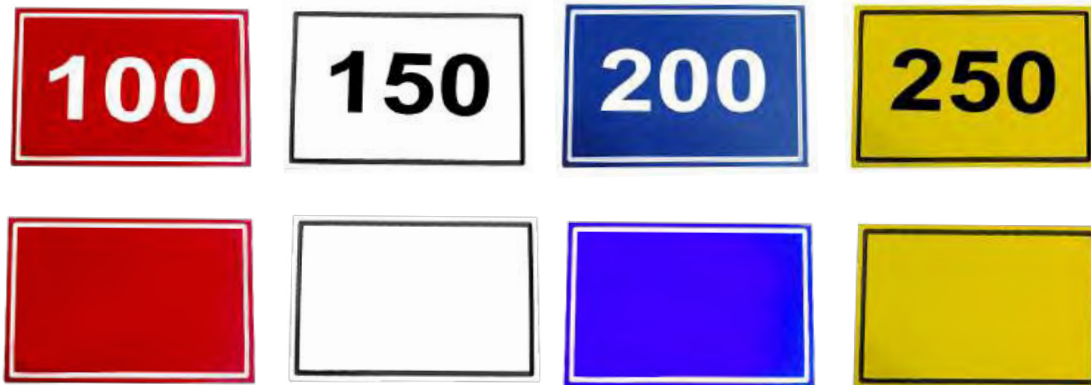

Call us for a quote for additional color options. Add logo to any marker above at additional cost.

PERMA-CORE COLOR OPTION KEY



Pricing is subject to change.

YARDAGE EASELS

Made of our premium Perma-core 1/2 inch thick material. Use the color chart on the left for available options. Flag colors and custom logos are also available to add.

LARGE DELUXE YARDAGE EASELS

32" X 22" - Single Or Double Sided



- PWPCYE-COLOR-SS-4 SINGLE SIDED - 4 YARDAGE
- PWPCYE-COLOR-SS-5 SINGLE SIDED - 5 YARDAGE
- PWPCYE-COLOR-SS-6 SINGLE SIDED - 6 YARDAGE
- PWPCYE-COLOR-SS-7 SINGLE SIDED - 7 YARDAGE
- PWPCYE-COLOR-DS-4 DOUBLE SIDED - 4 YARDAGE
- PWPCYE-COLOR-DS-5 DOUBLE SIDED - 5 YARDAGE
- PWPCYE-COLOR-DS-6 DOUBLE SIDED - 6 YARDAGE
- PWPCYE-COLOR-DS-7 DOUBLE SIDED - 7 YARDAGE

SMALL ECONOMY YARDAGE EASELS

16" X 24" - Single Or Double Sided



- PWPCEYE-COLOR-SS-4 SINGLE SIDED - 4 YARDAGE
- PWPCEYE-COLOR-DS-4 DOUBLE SIDED - 4 YARDAGE

CLOCK EASEL WITH YARDAGES

40" X 32" - Single Or Double Sided



- PWPCEY-COLOR-SS SINGLE SIDED - 6 YARDAGE
- PWPCEY-COLOR-DS DOUBLE SIDED - 6 YARDAGE

EASEL COLOR OPTION KEY



YARDAGE EASEL NUMBERS

Replacement Slider Numbers



- Sold in a set of 50 Numbers broken down in the following quantities:
 - Qty 8 each of #'s 0,5
 - Qty 6 each of # 1
 - Qty 4 each of #'s 2,3,4,6,7,8,9
- Aluminum is white and numbers are Black
- 3 in Dimensions – 3 inches tall x 2.25 inches wide

GCASN3 3 IN TALL

CUSTOMIZE YOUR OWN RANGE EASEL!



LOOKING FOR A PERSONALIZED EASEL?

We'll Customize Any of Our easels with your logo. Reach Out to Us for a Proof Within 1 Business Day At no Charge!

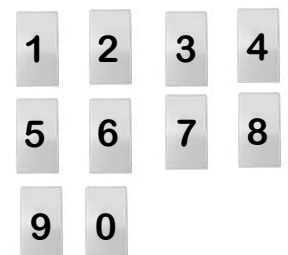

CLOCK EASEL- ECONOMY

24" Tall x 16" Wide

- Perma core plastic easel with clock included
- Add logo for extra charge



PWPC-CE-SS- _ SINGLE SIDED

PWPC-CE-DS- _ DOUBLE SIDED

EASEL COLOR OPTION KEY



CLOCK EASEL- DELUXE

32" Tall x 24" Wide

- Perma core plastic easel with clock included
- Add logo for extra charge



PWPCDCE-SS- _ SINGLE SIDED

PWPCDCE-DS- _ DOUBLE SIDED



CLUBHOUSE AND STARTER SIGNS WITH CLOCKS

SHAPE 11



SHAPE 4



SHAPE 2



COLOR OPTION KEY

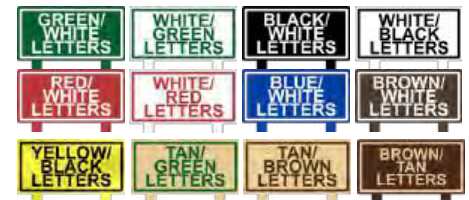

- Available in 12 color options
- Can be mounted to a post, hung from metal post, or mounted to wall.
- Mounting sold separately.
- Messages can be modified to fit your needs
- Add color option to end of part number

PWPC1424SC-S11_ 14" X 24" PLEASE KEEP PACE OF PLAY - SHAPE 11

PWPC1424SC-S4_ 14" X 24" PLEASE KEEP PACE OF PLAY - SHAPE 4

PWPC1424SCS-S2_ 14" X 24" TODAY'S COURSE RULES W/ SLIDERS- SHAPE 2

PWPC2436SCS-S2_ 24" X 36" TODAY'S COURSE RULES W/ SLIDERS- SHAPE 2

RECYCLED PLASTIC MOUNTING POST OPTIONS

5, 6, 7, Or 8 Feet Options

- Black, White, Brown, and Green Options Available.
- 4 inch x 4 inch material
- Great for perma-core plastic signs

RCPOST4460- _ 5' POST

RCPOST4472- _ 6' POST

RCPOST4484- _ 7' POST

RCPOST4496- _ 8' POST



CLOCKS ONLY

STD200900 WHITE, 12" - OUTDOOR WATER RESISTANT

STD200902 ATOMIC SILVER, 18" - OUTDOOR WATER RESISTANT

STD200901 BROWN, 15"

See other sign post options on page 26!

Pricing is subject to change.

PERMA CORE RANGE DIVOT PATTERN SIGN

Plastic Sign With Two Spikes
12" H x 18" W



PWPC1218-301- SINGLE SIDED

PWPC1218-301D- DOUBLE SIDED

SIGN COLOR OPTION KEY



PERMA CORE RANGE DIVOT PATTERN SIGN

Free Standing Plastic Easel
24" H x 16" W



PWPCE-301- BLACK SINGLE SIDED

PWPCE-301D- BLACK DOUBLE SIDED

EASEL COLOR OPTION KEY

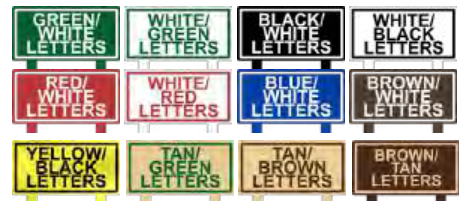

PERMA CORE RANGE DIVOT PATTERN SIGN

Plastic Sign Mounted on 18" Stake
12" H x 18" W

PWPC1218-301-35 SINGLE SIDED

PWPC1218-301D-35 DOUBLE SIDED

SIGN COLOR OPTION KEY



PORTABLE RECYCLED LUMBER SIGN POSTS

30" Stakes

PWRPS-400-30 GREEN

PWRPS-800-30 BLACK

PWRPS-200-30 WHITE

PORTABLE STEEL SIGN POSTS

STD10400 40" TALL

STD10418 18" TALL

- Pre-drilled to hold our 12" x 12" signs or 12" x 18" signs

See other sign post options on page 26!

PW SERIES ALUMINUM DIVOT PATTERN SIGNS

Can Be Mounted TO Portable Sign Posts



PWALS1212-302 12"X12"



PWALS1218-301 12"X18"



THE "SANDBAGGER" RANGE PICKER

The Picker You Want As A Partner



- Made in the U.S.A - Made from electroplated steel specifically for corrosion prevention and resistance to all outdoor elements.
- Designed to be the longest lasting picker on the market today!
- No front wheel - make sharp turns and maneuver without destruction to range grasses.
- No welding - all parts bolt together so you never have to cut and weld something to replace a part.
- Gangs won't tangle! Never risk leaving the vehicle to untangle gangs!
- 12" discs for the toughest picking and weather conditions! Made from extremely strong polycarbonate plastic for strength and flexibility. Plus, the added protection from our Green pigment reflects UV rays helping to extend discs' life.
- Split drum turning system - combined with our lightweight frame, each 34-disc drum is split into two 17 disc sections allowing picker to provide superior maneuverability on any terrain.
- 1800 ball capacity- 9 foot wide
- FREE 2 day shipping on all parts.

DREBPSB-3 3 SECTION - 9' WIDE - 1800 BALL

DREBPSB-5 5 SECTION - 15' WIDE - 3000 BALL

THE "ACE" RANGE PICKER

Big Ranges Need Big Pickers



This picker is the perfect choice for medium to high volume driving ranges. An extra 6 feet of coverage provides capacity for 2,700 balls for great picking efficiency.

- Made in the U.S.A - Made from electroplated steel specifically for corrosion prevention and resistance to all outdoor elements.
- Designed to be the longest lasting picker on the market today!
- No front wheel - make sharp turns and maneuver without destruction to range grasses.
- No welding - all parts bolt together so you never have to cut and weld something to replace a part.
- Gangs won't tangle! Never risk leaving the vehicle to untangle gangs!
- 14" oversized discs for the toughest picking and weather conditions! Made from extremely strong polycarbonate plastic for strength and flexibility. Plus, the added protection from our Green pigment reflects UV rays helping to extend discs' life.
- Split drum turning system - combined with our lightweight frame, each 34-disc drum is split into two 17 disc sections allowing picker to provide superior maneuverability on any terrain.
- 2700 ball capacity- 15 foot wide
- FREE 2 day shipping on all parts.

DREBPA-3 3 SECTION - 15' WIDE - 2700 BALL

DREBPA-5 5 SECTION - 25' WIDE - 4500 BALL

Pricing is subject to change.

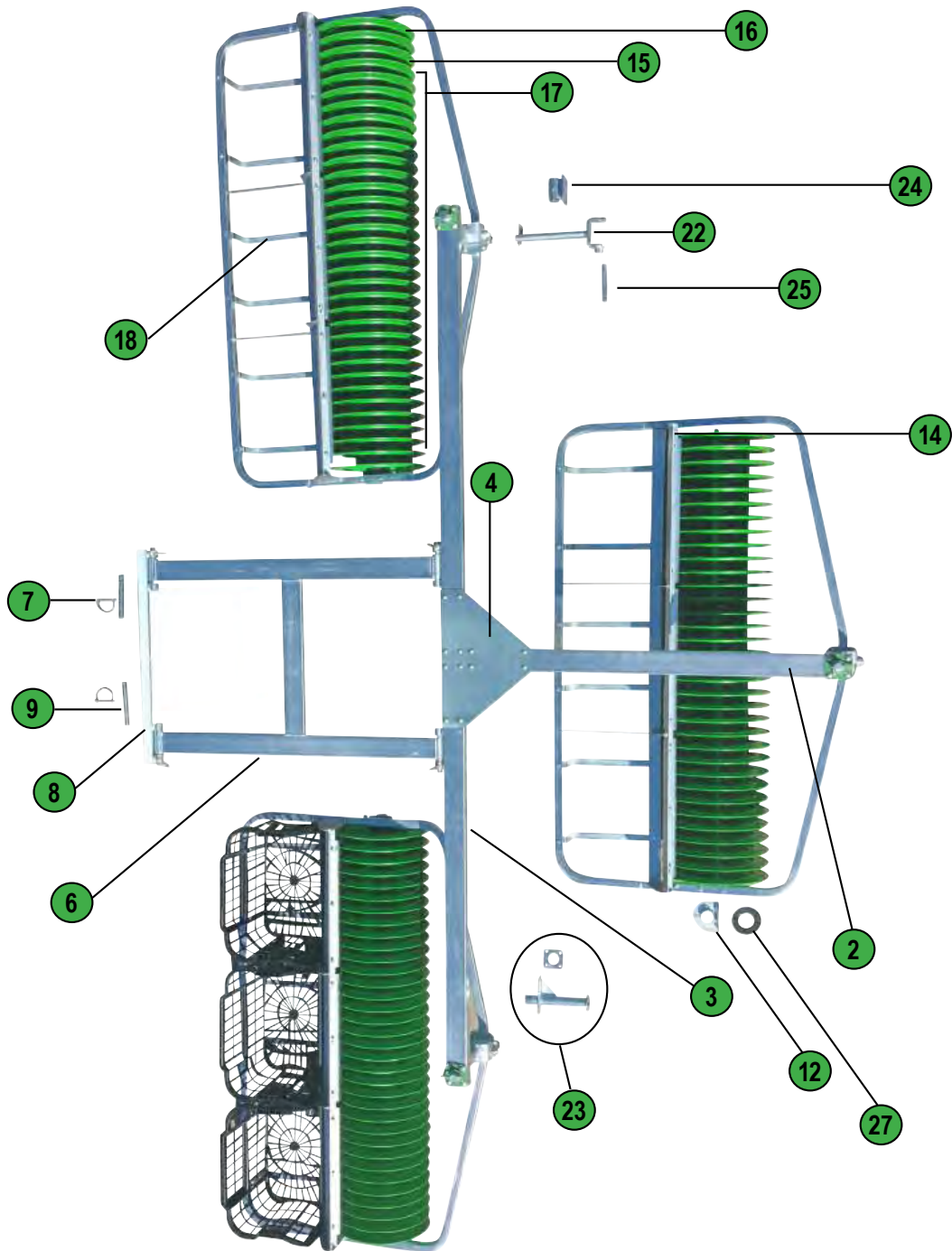

* EXPEDITED SHIPPING UPON REQUEST - WE HAVE ALL THE PARTS YOU NEED WHEN YOUR PICKER IS DOWN AND YOU NEED THEM RIGHT AWAY.

PARTS LIST FOR SANDBAGGER AND ACE SERIES PICKERS

	SANDBAGGER PART #	ACE SERIES PART #	DESCRIPTION
1	DREBP01	DREBP01-2	CENTER FRAME COMPLETE (INCLUDES 1 EA OF ITEM #2 AND 2 EACH OF ITEM #3)
2	DREBP02	DREBP02-2	CENTER FRAME CENTER
3	DREBP03	DREBP03-2	CENTER FRAME LEFT/RIGHT
4	DREBP04	DREBP04-2	CENTER GUSSET SET
5	DREBP05	DREBP05-2	PUSH SECTION COMPLETE (INCLUDES ITEMS 6-9)
6	DREBP06	DREBP06-2	PUSH SECTION ONLY (NO PUSH BAR)
7	DREBP07	DREBP07-2	¾" PUSH BAR PIN
8	DREBP08	DREBP08	PUSH BAR
9	DREBP09	DREBP09-2	LYNCH PIN
10	DREBP10	DREBP10-2	FRAME WITH HARDWARE (NO DRUM OR BASKETS)
11	DREBP11	DREBP11-2	PICKER AXLE
12	DREBP12-1	DREBP12-2	PICKER AXLE BRACKETS (PAIR)
13	DREBP13	DREBP13-2	THREADED ROD WITH NUT
14	DREBP14-1	DREBP14-2	PICKER COMB
15	DREBP15	DREBP15-2	PICKER DISC
16	DREBP16	DREBP16-2	END DISC
17	DREBP17	DREBP17-2	23 DISC SET COMPLETE
18	DREBP19	DREBP19	BASKET BAR
19	DREBP20	DREBP20-2	EXTENSION ARM COMPLETE (NOT PICTURED)
20	DREBP21	DREBP21	EXTENSION BRACKET (NOT PICTURED)
21	DREBP22	DREBP22	EXTENSION PIN (NOT PICTURED)
22	DREBP23	DREBP23	U-JOINT
23	DREBP24	DREBP24	U-JOINT BARREL
24	DREBP25	DREBP25	NOSE BEARING
25	DREBP26	DREBP26	NOSE BEARING PIN
26	DREBP27	DREBP27-2	PICKER SECTION COMPLETE (NO BASKETS)
27		DREBP31-2	SLIP DISK

*** EXPEDITED SHIPPING UPON REQUEST - WE HAVE ALL THE PARTS YOU NEED WHEN YOUR PICKER IS DOWN AND YOU NEED THEM RIGHT AWAY.**

Pricing is subject to change.

BALL COMB



DREBP14-1 SANDBAGGER SERIES

DREBP14-2 ACE SERIES

BASKET STRAP



DREBP19

NOSE BEARING

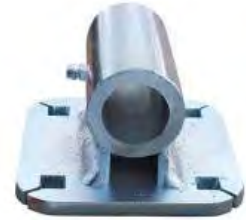

DREBP25

PICKER AXLE BRACKETS

DREBP12-1 SANDBAGGER SERIES

DREBP12-2 ACE SERIES



DREBPA-1 1 SECTION - 5' WIDE - 900 BALL

THE "LOB WEDGE" RANGE PICKER

Small Range Essential

This single section ball picker is a Dynamic Solution for the Smaller Range. It Packs All of the Same Quality As Its Big Brothers, But Comes in a Compact Package.

- Made in the U.S.A - Made from electroplated steel specifically for corrosion prevention and resistance to all outdoor elements.
- We designed our discs for the toughest picking and weather conditions! Made from extremely strong polycarbonate plastic for strength and flexibility. Plus, the added protection from our Green pigment reflects UV rays helping to extend discs' life.
- Compact design maneuvers easily around trees, target Greens, bunkers and yardage signs.
- 900 ball capacity- 5 foot wide
- FREE 2 day shipping on all parts.



CONVERSION KIT

Convert 3 Gang to 5 Or 7 Gang Pickers

DREBPCK-1 CONVERSION KIT - SANDBAGGER

DREBPCK-2 CONVERSION KIT - ACE SERIES

- 2 Extension Arms
- 2 Extension Brackets
- 2 Drum Assemblies
- 4 Baskets
- All Hardware



*** EXPEDITED SHIPPING UPON REQUEST - WE HAVE ALL THE PARTS YOU NEED WHEN YOUR PICKER IS DOWN AND YOU NEED THEM RIGHT AWAY.**

REPLACEMENT DRUMS

Our high quality drums not only fit our pickers, but we have options that fit many of the other pickers out there. Why settle for inferior drums on a picker you already have when you can buy our replacement drums with our premium disks (sometimes cheaper than factory direct).



- DREBP17** SANDBAGGER REPLACEMENT DRUM - 23 DISCS
- DREBP17-2** ACE REPLACEMENT DRUM - 34 DISCS (14" DISC)
- DREDR01** 21 DISK REPLACEMENT DRUM - FITS EASY PICKER
- DREDR03** 21 DISK REPLACEMENT DRUM - FITS WITTEK EAGLE LITE
- DREDR04** 22 DISK REPLACEMENT DRUM - FITS WITTEK RANGE ROVER AND BALL HAWK PICKERS (INCLUDES AXLE & 2 PILLOW BLOCK BEARINGS)
- DREDR05** 21 DISK REPLACEMENT DRUM - FITS HOLLROCK
- DREDR06** 23 DISK REPLACEMENT DRUM - FITS DERONE
- DREDR07** 34 DISK REPLACEMENT DRUM - FITS DERONE (14" DISC)
- STD82000** STANDARD GOLF REPLACEMENT DRUM



REPLACEMENT DISKS

- DREBP15** SANDBAGGER SERIES PICKER DISC
- DREBP15-2** ACE SERIES PICKER DISC



REPLACEMENT BASKETS

Our Baskets Also Fit Wittek and Derone Pickers.

- DREBP29** REPLACEMENT BASKET - PLASTIC

CART MOUNT BRACKETS



- DRECB10** CART BRACKET PIN
- DREBP08** PUSH BAR
- DRECB04** UNIVERSAL CART BRACKET
- DRECB03** JOHN DEERE GATOR BRACKET (2016 & OLDER)
- DRECB14** JOHN DEERE GATOR BRACKET
- DRECB09** EZ-GO 4X4 XD BRACKET (2013 & NEWER)
- DRECB12** EZ-GO RXV BRACKET
- DRECB08** CUSHMAN HAULER BRACKET (2013)
- DRECB06** KUBOTA TRACTOR MOUNT (2013 & NEWER)
- DRECB07** KUBOTA UTILITY CART BRACKET (2015 & NEWER)
- DRECB01** CLUB CAR BRACKET (PRE-2014)
- DRECB02** CLUB CAR BRACKET (2015 & NEWER)
- DRECB11** YAMAHA BRACKET (2003-2008)
- DRECB05** YAMAHA BRACKET (2009 & NEWER)

*** EXPEDITED SHIPPING UPON REQUEST - WE HAVE ALL THE PARTS YOU NEED WHEN YOUR PICKER IS DOWN AND YOU NEED THEM RIGHT AWAY.**

Pricing is subject to change.

“CYCLONE” RANGE BALL WASHER



We call this ballwasher the Cyclone because it creates a circulating deep clean on the balls removing all dirt and debris from them.

- The best value ballwasher on the market
- Made in the USA out of heavy duty steel and a powerful drive motor.
- 1 Year Warranty
- Heavy duty nylon brush
- Debris removal
- Cleaning rate: 15,000 balls per hour
- Dimensions: 33" L x 19" W x 30.5" H
- Hopper capacity: 500 balls
- Water capacity: 8 gallons
- Electrical: 110 or 220 Volt
- Motor: 1/3 HP
- **Equipped with GFI outlets for safety**

DREBW01 110 VOLT CYCLONE
DREBW01-220 220 VOLT CYCLONE

“TORNADO” BALL WASHER

The same ballwasher as the Typhoon, but includes a lift system that will lift balls into a range dispenser. Save time and money from purchasing an elevator system or loading by hand!

- 1 Year Warranty
- Heavy duty nylon brush
- Unique steel spiral for debris removal
- Cleaning rate: 30,000 balls per hour
- Dimensions: 34" L x 23" W x 38" H
- Hopper capacity: 800 balls
- Water capacity: 14 gallons
- Electrical: 110 or 220 Volt
- Motor: 1/2 HP
- Equipped with GFI outlets for safety

DREBWTOR 110 VOLT TORNADO
DREBWTOR-220 220 VOLT TORNADO

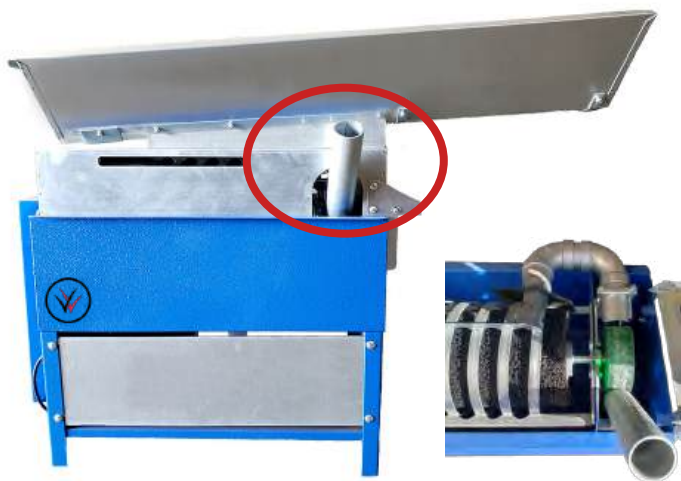

“TYPHOON” BALL WASHER



All of the same features as the cyclone, but a larger capacity model for bigger ranges.

- Made in the USA out of heavy duty steel and a powerful drive motor.
- 1 Year Warranty
- Heavy duty nylon brush
- Unique steel spiral for debris removal
- Cleaning rate: 30,000 balls per hour
- Dimensions: 34" L x 23" W x 38" H
- Hopper capacity: 800 balls
- Water capacity: 14 gallons
- Electrical: 110 or 220 Volt
- Motor: 1/2 HP
- Equipped with GFI outlets for safety

DREBW02 110 VOLT TYPHOON
DREBW02-220 220 VOLT TYPHOON

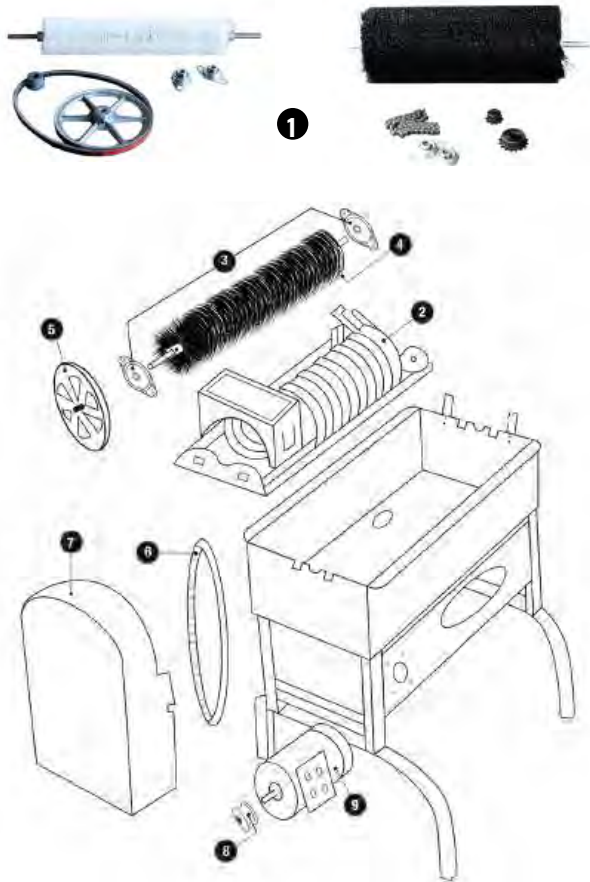

RANGE BALLWASHER REPAIR PARTS

We carry all of the parts you need to keep your ballwasher running smooth including rebuild kits when it is time for maintenance.

- 1 DREBW16 REBUILD KIT - CYCLONE
- 1 DREBW18-T REBUILD KIT - TYPHOON
- 2 DREBW10 CYCLONE SPIRAL
- 2 DREBW13-T TYPHOON SPIRAL
- 3 DREBW06 BRUSH BEARING
- 4 DREBW07 REPLACEMENT BRUSH - CYCLONE
- 4 DREBW07-T REPLACEMENT BRUSH - TYPHOON
- 5 DREBW04 LARGE PULLEY - CYCLONE
- 5 DREBW04-T LARGE SPROCKET - TYPHOON
- 6 DREBW03 DRIVE BELT - CYCLONE
- 6 DREBW03-T DRIVE CHAIN - TYPHOON
- 7 DREBW15 BELT GUARD - CYCLONE
- 7 DREBW14-T CHAIN GUARD - TYPHOON
- 8 DREBW05 SMALL PULLEY - CYCLONE
- 8 DREBW05-T SMALL SPROCKET - TYPHOON
- 9 DREBW31 110 VOLT DRIVE MOTOR - CYCLONE
- 9 DREBW31-T 110 VOLT DRIVE MOTOR - TYPHOON



CASTER WHEEL KIT OR LEG EXTENSION KIT

Both the Cyclone and the Typhoon have optional leg extensions to make the ballwasher taller or caster kits to make it mobile. Taller units can dispense into a barrel.



- DREBW18 CASTER KIT
- DREBW21 LEG EXTENSION KIT

WALK BEHIND BALL PICKER Single Unit



DRESP01

- Great unit for chipping or putting Greens
- 19" wide
- 300 ball capacity
- Premium materials make it corrosion resistant

WALK BEHIND BALL PICKER Double Unit



DRESP02

- Great unit for chipping or putting Greens
- 39.5" wide
- 600 ball capacity
- Premium materials make it corrosion resistant

Pricing is subject to change.

NITRO

NITRO PRACTICE RANGE BALL

NITRO range ball with 2-piece construction provides the necessary levels of performance that will make practicing more worthwhile.



- NITRO Premium White Tour Range Golf Ball
- Soft Feel
- Ultimate Range Experience
- 2-Piece Solid Core
- Durable Surlyn Cover
- Model # NRG300WB (White)
- Pack Size: 300 Balls / 25 Dozen

DRERBNP-WH NITRO 2-PIECE PRACTICE RANGE BALL, WHITE PER CASE (25 DOZEN)

NITRO LIMITED FLIGHT RANGE BALL

NITRO limited flight range ball is 20% limited in the distance, which is perfect for driving ranges that have real estate limitations.



- NITRO Premium Limited Flight Range Golf Ball
- Soft Feel
- Ultimate Range Experience
- 2-Piece Solid Core
- Durable Surlyn Cover
- Distance Limited
- Model # NRGLF300WB (White)
- Pack Size: 300 Balls / 25 Dozen

DRERBNL-WH NITRO 2-PIECE LIMITED FLIGHT RANGE BALL, WHITE PER CASE (25 DOZEN)

DRIVING RANGE BALLS

Premium Quality Balls for Every Range

- Best grade range ball on the market
- Premium tour ball-like feel, distance, and trajectory
- Consistent distance and trajectory, with no sacrifice to distance
- Stabilized inner core compound for smooth stroke feeling
- Unique Surlyn-blend coating gives incredible durability and fresh feel
- NIR drying system further improves durability & consistent ball surface
- Extremely durable (300 ID)
- Soft feel with 90 PGA Compression
- 392 aerodynamically optimized dimples

PREMIUM RANGE BALL

This Premium Range Ball is the #1 range ball on the market for cost-effectiveness.

Highest durability. Smooth feel. Sleek 3 stripe design. Perfect for your driving range.

LIMITED FLIGHT RANGE BALL

The 2 piece premium limited flight top range ball is made to meet the standards of driving ranges with short landing areas (below 250 yards).

With lower trajectory and distance potential (90-95% limited compared to premium top range ball), these balls are limited from going over the fence/net. Still the same highest durability, smooth stroke feeling, and the sleek design. Ideal for driving ranges with short landing areas.

- DRERBPR-WH** PREMIUM RANGE BALL, WHITE PER CASE (25 DOZEN)
- DRERBPR-YW** PREMIUM RANGE BALL, YELLOW PER CASE (25 DOZEN)
- DRERBLTD-WH** LIMITED FLIGHT RANGE BALL, WHITE PER CASE (25 DOZEN)
- DRERBLTD-YW** LIMITED FLIGHT RANGE BALL, YELLOW PER CASE (25 DOZEN)
- DRERBFL-WH** FLOATER RANGE BALL, WHITE PER CASE (25 DOZEN)



FLOATER RANGE BALL

The 2 Piece Premium Floater Ball is the #1 Floater ball in the market engineered to float with TOP RANGE BALL characteristics.



MONSTER MAT GOLF MAT

1.25" Nylon Turf Height

Transform your golf game with the Monster Mat Golf Mat – the gold standard for home simulators, driving ranges, and country clubs. Crafted in the U.S.A.

- 1 1/8" Z-Pro Fiber hitting the surface
- Includes (2) tee holders - one tee hole on each side of the mat. 4 total holes

DRERMMM 5FT X 5FT

DRERMMM-20 5FT X 20FT



Volume Discounts Available on Mat Orders of 10 Or More



TEE LINE TURF MAT

The Only Mat That Holds Wooden Tee

- Holds a wooden tee anywhere on the mat
- reduced "bounce effect" you get from other mats
- Also has 8 drilled holes for rubber tees
- 100% nylon fiber will not leave Green marks on clubs
- Made in the USA - water and mold resistant
- 60" x 60" square
- 5/8" closed cell shock resistant foam pad

DRERMTLP SQUARE TEE LINE MAT



Pricing is subject to change.



DUO TURF MAT
3/4" Nylon Turf Height

- 100% premium nylon tufted turf (straight and curled)
- Same fiber design and quality as our ultra mat, but a short turf height makes this a great value mat
- Allows better hitting experience and stable stance
- Excellent wear-and-tear and heat resistance
- cushion foam pad provides excellent shock absorption without any curling
- 8 tee holes for proper rotation

DRERMDT DUO TURF MAT



Volume Discounts Available On Mat Orders
Of 10 Or More

PRO TEACHING LINE MAT
3/4" Nylon Turf

- Designed for teaching pros & golf lessons at driving ranges
- 100% premium nylon tufted turf (curled). colorized yarns embedded onto the mat (does not fall out)
- Visible swing path and stance area
- cushion foam pad provides shock absorption and maximum protection
- 4 tee holes.
- Dimensions: 60 in x 60 in

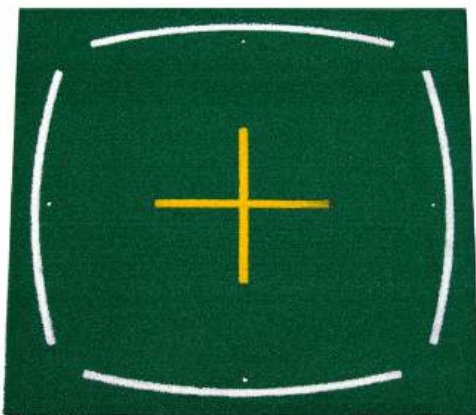

DRERMTM LINE MAT

CLASSIC FAIRWAY MAT
Classic Nylon Turf



- Keeping the fresh look for years with healthy curled turf
- 100% premium nylon tufted turf (curled)
- Excellent wear-and-tear and heat resistance
- Advanced shock absorption and maximum protection
- 8 tee holes.
- Dimensions: 60 in x 60 in

DRERFMW CLASSIC MAT

MAT REPLACEMENT INSERTS
Fits Most "Mat Systems"



HITTING AREA INSERT

- Fits most standard frames
- Premium nylon turf
- 4 tee holes
- 4 feet long x 1 foot wide

DRERMH1



STANCE AREA INSERT

- Fits most standard frames
- Premium nylon turf
- Comfortable and realistic feel
- 4 feet long x 4 feet wide

DRERMSM

42 DRIVING RANGE & PRACTICE AREA

ORIGINAL PYRAMID STACKER™ & TRAYS

- An industry favorite - simply pour balls into the stacker and leave a perfect pyramid on the tray
- Leaves a clean look for staged range balls
- Made of galvanized steel
- Use metal or plastic trays below

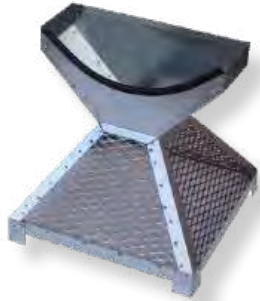

PYRAMID STACKERS

DREMP55	55 BALLS
DREMP91	91 BALLS
DREMP140	140 BALLS
DREMP204	204 BALLS
DREMP285	285 BALLS

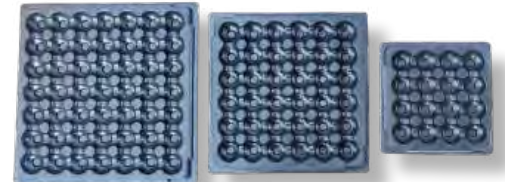

METAL STACKING TRAYS

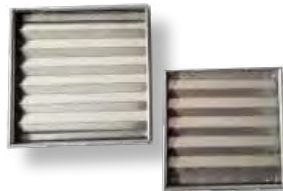

DREMT55	55 BALLS
DREMT91	91 BALLS
DREMT140	140 BALLS
DREMT204	204 BALLS
DREMT285	285 BALLS

PLASTIC STACKING TRAYS

DREPT55	55 BALLS
DREPT91	91 BALLS
DREPT140	140 BALLS
DREPT204	204 BALLS

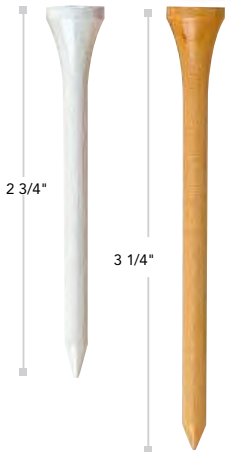

BULK GOLF TEES

Environmentally Friendly Bamboo

- Made from all natural bamboo.
- Available in natural, white or assorted mix
- Case of 10,000 bulk tees

DREBAM218-NA	2 1/8"	NATURAL
DREBAM218-WH	2 1/8"	WHITE
DREBAM234-NA	2 3/4"	NATURAL
DREBAM234-WH	2 3/4"	WHITE
DREBAM314-NA	3 1/4"	NATURAL
DREBAM314-WH	3 1/4"	WHITE

CASE OF 10,000 TEES



**We can custom print your golf tees
- custom colored tees available.
Call us for more information!**

PRE PACKAGED GOLF TEES

- Made from all natural bamboo.
- Available in natural, white or assorted mix
- Case of 10,000 bulk tees
- Bags of 50 tees
- 200 bags per box



DREBBT218-NA	2 1/8"	NATURAL
DREBBT218-WH	2 1/8"	WHITE
DREBBT234-NA	2 3/4"	NATURAL
DREBBT234-WH	2 3/4"	WHITE
DREBBT314-NA	3 1/4"	NATURAL
DREBBT314-WH	3 1/4"	WHITE

BAGS OF 50 TEES, 200 BAGS PER BOX

WOODEN TEE HOLDERS



DRERTW100	1" RUBBER TEE
DRERTW200	2" RUBBER TEE

RUBBER TEES



DRERT175	1.75"
DRERT200	2"
DRERT225	2.25"
DRERT250	2.5"
DRERT275	2.75"
DRERT300	3"
DRERT325	3.25"

Pricing is subject to change.



ROLLING GOLF BALL PICKER W/ RETRACTABLE HANDLE



- Will not fall apart like other versions
- Handle is screw on - no glue required & easy assembly
- 48" handle rotates to users of any height
- Comes apart for easy storage
- Green & White color scheme

PWRBP



THE CHIP N SWEEP
Range Ball Sweeper



- Will not fall apart like other versions
- Handle is screw on - no glue required & easy assembly
- 48" handle rotates to users of any height
- Comes apart for easy storage
- Green & White color scheme

DREBP

ORIGINAL BAG SHAG

Enclosedw/Zipper-CustomizedLogoOptionAvailable



- DREBS-RD RED
- DREBS-BK BLACK
- DREBS-GR GREEN
- DREBS-BL BLUE

RANGER BAG SHAG

Open Top



- DRERBS-RD RED
- DRERBS-BK BLACK
- DRERBS-GR GREEN

SHAG TUBE

Aluminum Tubes



DREST
HOLDS 23 BALLS

STACKABLE RANGE BAGS



- DRERBC25 25 BALL BAG
- DRERBC40 40 BALL BAG
- DRERBC60 60 BALL BAG
- DRERBC85 85 BALL BAG

AVAILABLE IN RED, BLACK OR GREEN

COTTON RANGE BAGS

Customized Logo Option Available



- DRERBCT25 25 BALL BAG
- DRERBCT40 40 BALL BAG
- DRERBCT60 60 BALL BAG
- DRERBCT85 85 BALL BAG

AVAILABLE IN RED, BLACK, OR GREEN

MESH RANGE BAGS



- DRERBM25 25 BALL BAG
- DRERBM35 35 BALL BAG
- DRERBM50 50 BALL BAG
- DRERBM95 95 BALL BAG

AVAILABLE IN BLUE, GREEN, GOLD OR BLACK



44 DRIVING RANGE & PRACTICE AREA

COLOR OPTION KEY



GREEN BROWN BLACK WALNUT GREY

All crates can be customized with logo or plain.
Call us for more color & logo options.

LOGO OPTION KEY



LEXAN



ENGRAVED



CAST BRONZE



CAST ALUMINUM

150 RANGE CRATE DISPENSER

Stores 150 Range Balls



- GCA100-GN GREEN
- GCA100-BK BLACK
- GCA100-BR BROWN
- GCA100-CG COASTAL GREY

250 RANGE CRATE DISPENSER

Stores 250 Range Balls



- GCA200-GN GREEN
- GCA200-BK BLACK
- GCA200-BR BROWN
- GCA200-CG COASTAL GREY

300 RANGE CRATE DISPENSER

Stores 300 Range Balls



- PAR3440 GREEN
- PAR3441 BLACK
- PAR3442 REDWOOD

350 RANGE CRATE DISPENSER

Stores 350 Range Balls



- GCA300-GN GREEN
- GCA300-BK BLACK
- GCA300-BR BROWN
- GCA300-CG COASTAL GREY

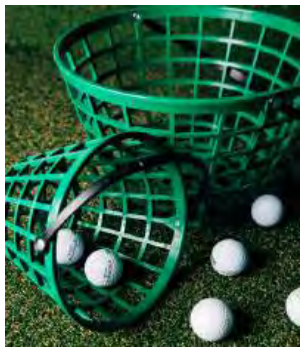

RANGE BASKETS

Black, Green Or Yellow



- DRERB25_ 25 BALL BASKET
- DRERB40_ 40 BALL BASKET
- DRERB70_ 70 BALL BASKET
- DRERB100_ 100 BALL BASKET
- DRERB200_ 200 BALL BASKET

_ = Enter Color Option In Final Spot (Yellow=YW, Black=BK, Green =GR)

BALL CRATES

Black Or Green



LARGE CRATES

19" x 33" x 11"

- DREBCLB LARGE BLACK
- DREBCLG LARGE GREEN

SMALL CRATES

13" x 13" x 11"

- DREBCSB SMALL BLACK
- DREBCSG SMALL GREEN

RANGE BALL STORAGE BOX

Stores Up to 5000 Golf Balls



- Lockable (lock sold separately)
- 39" wide x 28" deep x 27" tall

- PAR3350 HUNTER GREEN
- PAR3351 BLACK
- PAR3352 REDWOOD

RANGE BALL TRAYS



- DREBT-G ARMY GREEN TRAY
- DREBT-B BLACK TRAY

Pricing is subject to change.

PERMA CORE CHIPPING YARDAGE TARGETS

Easy to Read Set of 9 Yardages from 20-100 Yards
15" W x 9" H

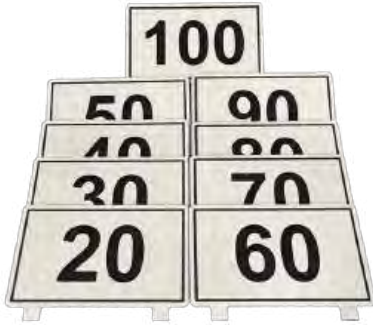

Custom Number Options Available!

- PWPC-CT-1 GREEN WITH WHITE NUMBERS
- PWPC-CT-2 WHITE WITH GREEN NUMBERS
- PWPC-CT-3 BLACK WITH WHITE NUMBERS
- PWPC-CT-4 BLUE WITH WHITE NUMBERS
- PWPC-CT-5 RED WITH WHITE NUMBERS
- PWPC-CT-6 WHITE WITH BLACK NUMBERS
- PWPC-CT-7 BROWN WITH WHITE NUMBERS
- PWPC-CT-8 YELLOW WITH BLACK NUMBERS
- PWPC-CT-9 TAN WITH GREEN NUMBERS
- PWPC-CT-10 GREEN WITH TAN NUMBERS
- PWPC-CT-11 TAN WITH BROWN NUMBERS

RANGE TARGET NET

4 Foot Diameter



- Pads come in three colors - yellow, white, blue, and red
- Pads sold separately
- DRERTN-4-WH TARGET NET W/WHITE PADS
- DRERTN-4-RD TARGET NET W/RED PADS
- DRERTN-4-YW TARGET NET W/YELLOW PADS
- DRERTN-4-BL TARGET NET W/BLUE PADS

THE BULLSEYE

Premium Pitching & Chipping Targets

- 36" tall x 26" wide
- Made of the highest quality materials and designed to last
- Shipped with optional foam padding kit to give unit extra protection from impact of hard hit golf balls
- Easy to assemble - takes less than 2 minutes to assemble
- Bright colors make them highly visible from any distance
- Base can be filled with water to weigh it down in the wind
- Design turns chipping into a fun game
- No net means you can easily clean up balls in and around it



- DRETG-3Y YELLOW
- DRETG-3R RED
- DRETG-3G GREEN
- DRETG-3B BLUE



GOLF HITTING POWER CAGE & TARGET

10ft. High x 10ft. Wide x 10ft. Deep



- Includes net and target
- Mat sold separately

DREHC-10

Need mats for your power cage? See page for mat options!



PREMIUM RANGE POLES

COMPLETE RANGE POLE KITS

Includes Ground Anchor, Flag, Flagstick

STRIPED



PWRPST-RD PWRPST-RB PWRPST-KG PWRPST-YW PWRPST-OR PWRPST-BW PWRPST-PK PWRPST-PR

SOLID

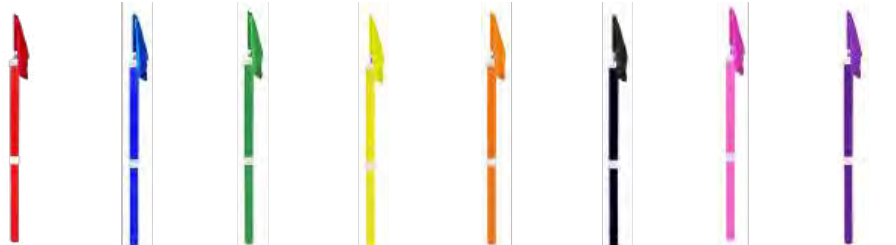

PWRPS-RD PWRPS-RB PWRPS-KG PWRPS-YW PWRPS-OR PWRPS-BW PWRPS-PK PWRPS-PR PWRPS-WH

CUSTOMIZE!



PWRPS-CUST

Our Premium Range Poles Are The Best Here's Why:

- Made with the thickest 4" pipe on the market for a longer life that stands up to the toughest use
- We ship our poles in two pieces so you save a ton in shipping costs
- Our flags are the highest quality 400 Denier oversized range flags (18" x 25")
- Our complete kit is the best value on the market
- We stock the colors below, but can make custom colors also



COMPLETE RANGE POLE KITS

No Flags - Poles and Anchors Only

STRIPED \$225.00



PWM09ST-RD PWM09ST-RB PWM09ST-KG PWM09ST-YW PWM09ST-OR PWM09ST-BW PWM09ST-PK PWM09ST-PR

SOLID \$245.00



PWM09S-RD PWM09S-RB PWM09S-KG PWM09S-YW PWM09S-OR PWM09S-BW PWM09S-PK PWM09S-PR PWM09S-WH

CUSTOMIZE!



PWM09ST-CUST

OVERSIZED RANGE POLE FLAGS

18 x 25 Solid or Checkered

- Constructed of 400 denier premium nylon
- 1/2" one-piece border with zig-zag stitch
- Bar-tac reinforced corners
- Available with tube, soft tube or grommet

SOLID - | CHECKERED -

BLACK



PINK



PURPLE



WHITE



BEIGE



BONE



BROWN



RED



ROYAL BLUE



KELLY GREEN



YELLOW



ORANGE



PW18X25PL-RD PW18X25PL-RB PW18X25PL-KG PW18X25PL-YW PW18X25PL-OR

PW18X25PL-BK PW18X25PL-PK PW18X25PL-PR PW18X25PL-BK PW18X25PL-BA PW18X25PL-BN PW18X25PL-BR PW18X25PL-OB PW18X25PL-CG PW18X25PL-FG PW18X25PL-FU

RED/WHITE BLUE/WHITE GREEN/WHITE BLACK/WHITE YELLOW/BLACK



PW18X25CK-RW PW18X25CK-WB PW18X25CK-GW PW18X25CK-BW PW18X25CK-YB

Pricing is subject to change.



Sign posts sold separately. Visit sign post section on page 26 for more options.

VERTICAL YARDAGE TARGETS

12" W x 48" T

- PWPCYV-50-1 GREEN 50
- PWPCYV-75-2 WHITE 75
- PWPCYV-100-5 RED 100
- PWPCYV-150-3 BLACK 150
- PWPCYV-200-4 BLUE 200
- PWPCYV-250-8 YELLOW 250



HORIZONTAL YARDAGE TARGETS

31" W x 24" T



Sign posts sold separately. Visit sign post section on page 26 for more options.

- PWPCYH-50-1 GREEN 50
- PWPCYH-75-2 WHITE 75
- PWPCYH-100-5 RED 100
- PWPCYH-150-3 BLACK 150
- PWPCYH-200-4 BLUE 200
- PWPCYH-250-8 YELLOW 250



ARCH YARDAGE TARGETS

36" W x 20" T



Sign posts sold separately. Visit sign post section on page 26 for more options.

- PWPCYA-50-1 GREEN 50
- PWPCYA-75-2 WHITE 75
- PWPCYA-100-5 RED 100
- PWPCYA-150-3 BLACK 150
- PWPCYA-200-4 BLUE 200
- PWPCYA-250-8 YELLOW 250



OVAL YARDAGE TARGETS

47" W x 30" T



Two 4" X 4" 6 feet sign posts included

- PWPCYO-50-1 GREEN 50
- PWPCYO-75-2 WHITE 75
- PWPCYO-100-5 RED 100
- PWPCYO-150-3 BLACK 150
- PWPCYO-200-4 BLUE 200
- PWPCYO-250-8 YELLOW 250



YARDAGE POST OPTIONS

RECYCLED PLASTIC MOUNTING POST OPTIONS

5, 6, 7, Or 8 Feet Options

- RCPOST4460- 5' POST
- RCPOST4472- 6' POST
- RCPOST4484- 7' POST
- RCPOST4496- 8' POST



- Black, White, Brown, and Green
- 4 inch x 4 inch material
- Great for yardage posts

8 FT U-CHANNEL SIGN POST

- Green baked enamel u-channel posts resist corrosion.
- Tapered end easily drives into the ground.
- 3/8" Holes on 1" centers to easily attach signs.
- Meets mutcd standards.
- Pair with custom aluminum course signs. Sold separately.

PWPOSTUCG-8



48 DRIVING RANGE & PRACTICE AREA



CIRCLE YARDAGE TARGETS

24" Diameter

- PWPCYC-50-1 GREEN 50
- PWPCYC-75-2 WHITE 75
- PWPCYC-100-5 RED 100
- PWPCYC-150-3 BLACK 150
- PWPCYC-200-4 BLUE 200
- PWPCYC-250-8 YELLOW 250



Targets include target stand (see pictured) and two spikes



BULLSEYE YARDAGE TARGETS

24" Diameter

- PWPCYB-50-1 GREEN 50
- PWPCYB-75-2 WHITE 75
- PWPCYB-100-5 RED 100
- PWPCYB-150-3 BLACK 150
- PWPCYB-200-4 BLUE 200
- PWPCYB-250-8 YELLOW 250

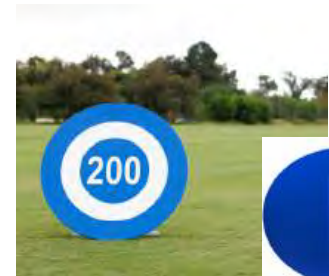

Targets include target stand (see pictured) and two spikes

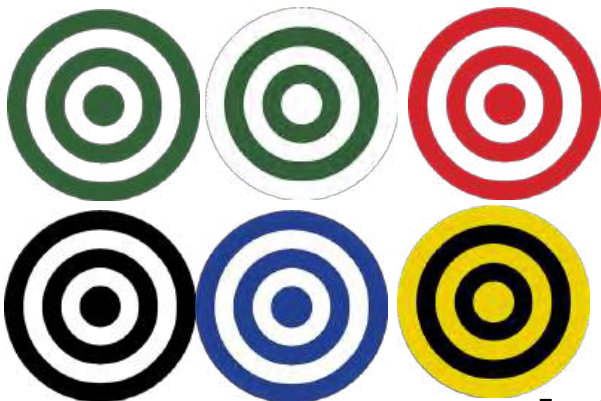

BULLSEYE TARGETS

24" Diameter

- PWPCBT-50-1 GREEN/WHITE
- PWPCBT-75-2 WHITE/GREEN
- PWPCBT-100-5 RED/WHITE
- PWPCBT-150-3 BLACK/WHITE
- PWPCBT-200-4 BLUE/WHITE
- PWPCBT-250-8 YELLOW/BLACK

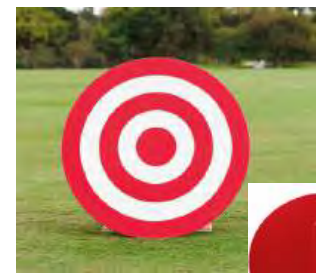

Targets include target stand (see pictured) and two spikes



CUSTOM TARGETS

24" Diameter

- PWPCCT-50-1 GREEN/WHITE
- PWPCCT-75-2 WHITE/GREEN
- PWPCCT-100-5 RED/WHITE
- PWPCCT-150-3 BLACK/WHITE
- PWPCCT-200-4 BLUE/WHITE
- PWPCCT-250-8 YELLOW/BLACK



Targets include target stand (see pictured) and two spikes

Pricing is subject to change.

YARDAGE EASELS

Made of our premium Perma-core 1/2 inch thick material. Use the color chart on the left for available options. Flag colors and custom logos are also available to add.

LARGE DELUXE YARDAGE EASELS

32" X 22" - Single Or Double Sided



- PWPCYE-COLOR-SS-4 SINGLE SIDED - 4 YARDAGE
- PWPCYE-COLOR-SS-5 SINGLE SIDED - 5 YARDAGE
- PWPCYE-COLOR-SS-6 SINGLE SIDED - 6 YARDAGE
- PWPCYE-COLOR-SS-7 SINGLE SIDED - 7 YARDAGE
- PWPCYE-COLOR-DS-4 DOUBLE SIDED - 4 YARDAGE
- PWPCYE-COLOR-DS-5 DOUBLE SIDED - 5 YARDAGE
- PWPCYE-COLOR-DS-6 DOUBLE SIDED - 6 YARDAGE
- PWPCYE-COLOR-DS-7 DOUBLE SIDED - 7 YARDAGE

SMALL ECONOMY YARDAGE EASELS

16" X 24" - Single Or Double Sided



- PWPCEYE-COLOR-SS-4 SINGLE SIDED - 4 YARDAGE
- PWPCEYE-COLOR-DS-4 DOUBLE SIDED - 4 YARDAGE

CLOCK EASEL WITH YARDAGES

40" X 32" - Single Or Double Sided



- PWPCEY-COLOR-SS SINGLE SIDED - 6 YARDAGE
- PWPCEY-COLOR-DS DOUBLE SIDED - 6 YARDAGE

CUSTOMIZE YOUR OWN RANGE EASEL!



LOOKING FOR A PERSONALIZED EASEL?

We'll Customize Any of Our easels with your logo. Reach Out to Us for a Proof Within 1 Business Day At no Charge!

EASEL COLOR OPTION KEY

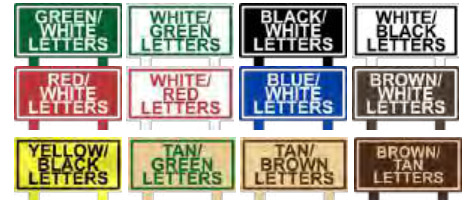

YARDAGE EASEL NUMBERS

Replacement Slider Numbers



- Sold in a set of 50 Numbers broken down in the following quantities:
 - Qty 8 each of #'s 0,5
 - Qty 6 each of # 1
 - Qty 4 each of #'s 2,3,4,6,7,8,9
- Aluminum is white and numbers are Black
- 3 in Dimensions – 3 inches tall x 2.25 inches wide

GCASN3 3 IN TALL

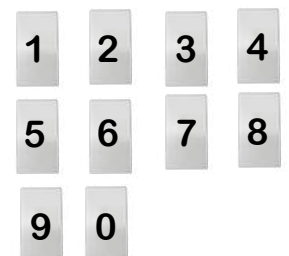

50 DRIVING RANGE & PRACTICE AREA

PERMA CORE LAMINATE RANGE DIVIDERS

Choose Plain, Logo Or Divot Pattern Designs



- 44" long x 4" high x 1/2" thick
- Includes stainless steel spikes
- Divot pattern design shows golfers how to maximize range space and is double sided
- Logo style is a double sided design
- Available in all 11 of our perma core colors detailed in our sign sections

RANGE DIVIDER COLOR OPTION KEY



- PWPCTD-DIV- _ DIVOT PATTERN DESIGN
- PWPCTD-LOG- _ CUSTOM LOGO DESIGN
- PWPCTD-PL- _ PLAIN



Double Spike Divider Ideal for Grass



Foot Pad Divider Ideal for Hard Surfaces

COLOR OPTION KEY



LOGO OPTION KEY



All Range Dividers can be customized with or without logo and with foot pads or flat with spikes. Call Us For More Color options as colors can be combined for two-tone look.

DELUXE ARCHED RANGE DIVIDER

40" x 12" x 2'
12 Color Options



- RCPRD-DA-GN GREEN
- RCPRD-DA-BK BLACK
- RCPRD-DA-BR BROWN

TRADITIONAL RANGE DIVIDER

48" x 4" x 2"



- RCPRD-AR-GN GREEN
- RCPRD-AR-BK BLACK
- RCPRD-AR-BR BROWN

TRIBUTE RANGE DIVIDER

48" x 4" x 2'



- RCPRD-TR-GN GREEN
- RCPRD-TR-BK BLACK
- RCPRD-TR-BR BROWN

RECYCLED LUMBER TEE DIVIDERS

48" x 4" x 2"



UPRIGHT STYLE FLAT STYLE

- RCPRD-US-GN GREEN UPRIGHT STYLE
- RCPRD-US-BK BLACK UPRIGHT STYLE
- RCPRD-US-BR BROWN UPRIGHT STYLE
- RCPRD-FS-GN GREEN FLAT STYLE
- RCPRD-FS-BK BLACK FLAT STYLE
- RCPRD-FS-BR BROWN FLAT STYLE

Includes stainless steel spikes

METAL TEE DIVIDERS

31" x 61" x 9"



- DRETD01GN GREEN
- DRETD01BK BLACK

Divider has sturdy feet with bolt holes to safely anchor to your driving range surface.

RANGE ALIGNMENT ROPE

100 Feet Long

- 10 foot spacing markers to evenly space range dividers
- Winds back up on spool when done



STD36700

Pricing is subject to change.

COLOR OPTION KEY



GREEN BROWN BLACK WALNUT GREY

Call us for more color & logo options. Colors can be combined for two-tone look.

LOGO OPTION KEY



LEXAN ENGRAVED CAST BRONZE CAST ALUMINUM



RECYCLED SQUARE CLUB WASHER

W/ Internal Brushes



- Attractive and maintenance-free housing for cleaning clubs
- Includes durable brushes that are gentle on clubs while offering quick and efficient cleaning.
- Choose green, brown, black or two tone color options

- RCPCW03-GN** HUNTER GREEN
- RCPCW03-BR** BROWN
- RCPCW03-BK** BLACK
- RCPCW03-BB** BLACK W/ BROWN TRIM
- RCPCW03-GB** GREEN WITH BLACK TRIM

ROUND CLUB WASHERS

W/ Internal Brushes

- Attractive and maintenance-free housing for cleaning clubs
- Includes durable brushes that are gentle on clubs while offering quick and efficient cleaning.
- Choose green, brown or black



- RCPCW01-GN** HUNTER GREEN
- RCPCW01-BR** BROWN
- RCPCW01-BK** BLACK

RANGE MATE
Club Washer



- 9 gallon, fade resistant polyethylene container
- When ordering replacement brushes, unit requires two

- STD01650** GREEN GRANITE
- STD01602** SINGLE BRUSH

PAR AIDE CLUB WASHER
Mounting Accessories



- PAR250-02** GREEN CLUB WASHER
- PAR250-00** BLACK CLUB WASHER
- PAR260** MOUNTING SPIKE
- PAR275** PIPE OR WALL MOUNT BRACKET
- PAR254** REPLACEMENT BRUSHES (2)

RANGE PRO
Club Washer



- Water bucket with hand brush included
- Convenient towel bar and hooks for various placement option

- PAR3310** GREEN
- PAR3315** BLACK
- PAR3316** REDWOOD

52 DRIVING RANGE & PRACTICE AREA

SINGLE POST BAG STAND

Single Post w/ Three Spikes
14" L x 16" W x 36" H



- RCPBS-SP-GN GREEN
- RCPBS-SP-BK BLACK
- RCPBS-SP-BR BROWN

FOLDING BAG STAND

16" L x 16" W x 26" H



- RCPBS-RF-GN GREEN
- RCPBS-RF-BK BLACK
- RCPBS-RF-BR BROWN

TRADITIONAL BAG STAND

21" L x 16" W x 28" H



- RCPBS01-GN GREEN
- RCPBS01-BK BLACK
- RCPBS01-BR BROWN

COLOR OPTION KEY



LOGO OPTION KEY



LEXAN ENGRAVED CAST BRONZE CAST ALUMINUM

All bag stands can be customized with or without logo and no cup holders, one cup holder, two cup holders, and club notches.

Bag racks can be customized with 5 to 8 bag stalls and logo for each style.

Call us for more color options as colors can be combined for two-tone look.

DELUXE BAG STAND

19" L x 21" W x 28" H



- RCPBS02-GN GREEN
- RCPBS02-BK BLACK
- RCPBS02-BR BROWN

REGAL BAG STAND

w/Tee Holes & Two Cup Holders
21" L x 19" W x 28" H



- RCPBS-RFCH2-GN GREEN
- RCPBS-RFCH2-BK BLACK
- RCPBS-RFCH2-BR BROWN

CENTURY BAG STAND

W/Cup Holder & Logo Plate
19" L x 21" W x 28" H



- RCPBS-CFL-GN GREEN
- RCPBS-CFL-BK BLACK
- RCPBS-CFL-BR BROWN

PREMIUM BAG RACK

74" L x 18" W x 32" H



- RCPBR1-5GN GREEN
- RCPBR1-5BK BLACK
- RCPBR1-5BR BROWN

CLUBHOUSE BAG RACK

74" L x 18" W x 32" H



- RCPBR-CH5-GN GREEN
- RCPBR-CH5-BK BLACK
- RCPBR-CH5-BR BROWN

IMPERIAL BAG RACK

74" L x 18" W x 46" H



- RCPBR-IL5-GN GREEN
- RCPBR-IL5-BK BLACK
- RCPBR-IL5-BR BROWN

IMPERIAL BAG RACK

74" L x 18" W x 46" H



- RCPBR-15-GN GREEN
- RCPBR-15-BK BLACK
- RCPBR-15-BR BROWN

DELUXE BAG RACK

46" L x 18" W x 36" H



- RCPBR-DCH5-GN GREEN
- RCPBR-DCH5-BK BLACK
- RCPBR-DCH5-BR BROWN

MODULAR 3 BAG RACK

44" L x 34" W x 18" H



- RCPBR-M3-GN GREEN
- RCPBR-M3-BK BLACK
- RCPBR-M3-BR BROWN

PERMANENT BAG RACK

Holds 10 Golf Bags



- RCPBR-PER5-GN GREEN
- RCPBR-PER5-BK BLACK
- RCPBR-PER5-BR BROWN

PREMIUM BAG RACK

Holds 10 Golf Bags



- RCPBR-PRT5-GN GREEN
- RCPBR-PRT5-BK BLACK
- RCPBR-PRT5-BR BROWN

Pricing is subject to change.

COLOR OPTION KEY



Call us for more color & logo options. Colors can be combined for two-tone look.

LOGO OPTION KEY



LEXAN ENGRAVED CAST BRONZE CAST ALUMINUM



BEECHWOOD SIDE LOAD TRASH CONTAINER

16 Gallon
17" L x 17" W x 31" H

- RCPTC-BW-GN HUNTER GREEN
- RCPTC-BW-BK BLACK
- RCPTC-BW-BR BROWN

SQUARE SLATTED TRASH CONTAINER

32 Gallon w/Lid & Liner
26" L x 20" W x 29" H



- RCPTC-SS32-GN HUNTER GREEN
- RCPTC-SS32-BK BLACK
- RCPTC-SS32-BR BROWN

SIERRA SQUARE TOP LOAD TRASH CONTAINER

26 Gallon w/Lid Off Lid & Liner
19" L x 19" W x 35" H



- RCPTC-TST26-GN HUNTER GREEN
- RCPTC-TST26-BK BLACK
- RCPTC-TST26-BR BROWN



CENTURY CURVE TOP SIDE LOAD TRASH CONTAINER

26 Gallon
19" L x 19" W x 37" H

- RCPTC-CT-GN HUNTER GREEN
- RCPTC-CT-BK BLACK
- RCPTC-CT-BR BROWN



DOUBLE RECYCLE CONTAINER

26 Gallon liners
37" L x 19" W x 45" H

- RCPRC-D26-GN HUNTER GREEN
- RCPRC-D26-BK BLACK
- RCPRC-D26-BR BROWN



TRIPLE TRASH & TOWEL STATION

26 Gallon liners
72" L x 19" W x 45" H

- RCPTCTS-T26-GN HUNTER GREEN
- RCPTCTS-T26-BK BLACK
- RCPTCTS-T26-BR BROWN



SIERRA SQUARE TOP LOAD TRASH CONTAINER

16 Gallon w/Lid Off Lid & Liner
17" L x 17" W x 28" H

- RCPTC-TST16-GN HUNTER GREEN
- RCPTC-TST16-BK BLACK
- RCPTC-TST16-BR BROWN



SQUARE SLATTED TRASH CONTAINER

32 Gallon w/Lid & Liner
26" L x 20" W x 24" H

- RCPTC-SS20-GN HUNTER GREEN
- RCPTC-SS20-BK BLACK
- RCPTC-SS20-BR BROWN

COLOR OPTION KEY



GREEN BROWN BLACK WALNUT GREY

Call us for more color & logo options. Colors can be combined for two-tone look.

LOGO OPTION KEY



LEXAN ENGRAVED CAST BRONZE CAST ALUMINUM



TRASH PRO 30

30 Gallon
28" L x 22" W x 43" H

- PAR3810 HUNTER GREEN
- PAR3811 BLACK
- PAR3812 REDWOOD



SQUARE TOP LOAD TRASH CONTAINER

16 & 25 Gallon w/Lid Off Lid & Liner
16" L x 16" W x 36" H

- RCPTCST16-GN HUNTER GREEN
- RCPTCST16-BK BLACK
- RCPTCST16-BR BROWN
- RCPTCST16-BB BLACK W/ BROWN TRIM
- RCPTCST16-GB GREEN W/ BLACK TRIM
- RCPTCST25-GN HUNTER GREEN
- RCPTCST25-BK BLACK
- RCPTCST25-BR BROWN
- RCPTCST25-BB BLACK W/ BROWN TRIM
- RCPTCST25-GB GREEN W/ BLACK TRIM



TRASH PRO 20

20 Gallon
20" L x 20" W x 32" H

- PAR3830 HUNTER GREEN
- PAR3831 BLACK
- PAR3832 REDWOOD



COMBINATION TRASH AND RECYCLE BIN

13 Gallon
18" L x 33" W x 35" H

- RCPTCDU-GN HUNTER GREEN
- RCPTCDU-BK BLACK
- RCPTCDU-BR BROWN
- RCPTCDU-BB BLACK W/ BROWN TRIM
- RCPTCDU-GB GREEN W/ BLACK TRIM



TRASH PRO 10

10 Gallon
18" L x 14" W x 33" H

- PAR3820 HUNTER GREEN
- PAR3821 BLACK
- PAR3822 REDWOOD



SQUARE SIDE LOAD TRASH CONTAINER

26 Gallon w/Lid Off Lid & Liner
19" L x 16" W x 41" H

- RCPTCSS26H-GN HUNTER GREEN
- RCPTCSS26H-BK BLACK
- RCPTCSS26H-BR BROWN



ROUND TRASH CANS

10 or 20 gallon

- RCPTCR10-GN 10 GAL HUNTER GREEN
- RCPTCR10-BK 10 GAL BLACK
- RCPTCR10-BR 10 GAL BROWN
- RCPTCR20-GN 20 GAL HUNTER GREEN



SQUARE REPLACEMENT TRASH LINERS

16 & 26 Gallons

- RCPTL-S16 SQUARE 16 GAL.
- RCPTL-S26 SQUARE 26 GAL.



ROUND REPLACEMENT TRASH LINERS

20 & 32 Gallons

- RCPTL-R20 ROUND 20 GAL.
- RCPTL-R32 ROUND 32 GAL.

Pricing is subject to change.

9 GALLON TAPERED LITTER CADDIE



- STD13400 YELLOW WITH SPIKE
- STD13150 RED WITH SPIKE
- STD13152 RED WITH BASE
- STD13700 GREEN WITH SPIKE
- STD13800 GREEN WITH BASE
- STD13175 BLUE WITH SPIKE
- STD13177 BLUE WITH BASE
- STD13195 BLACK WITH SPIKE
- STD13197 BLACK WITH BASE
- STD13199 CUSTOM LOGO

20 GALLON STAINLESS LITTER CADDIE



- STD13953 RED WITH BASE
- STD13978 GREEN WITH BASE
- STD13998 BLACK WITH BASE
- STD13950 RED WITH SPIKE
- STD13975 GREEN WITH SPIKE
- STD13995 BLACK WITH SPIKE

CEASE FIRE CIGARETTE BUTT RECEPTACLE



- JUS26800D BLACK
- JUS26800G GREEN
- JUS26800B BEIGE
- JUS26800T TERRACOTTA

30 GALLON TAPERED LITTER CADDIE



- Perfectly shaped to properly contain trash contents.
- 20-gauge steel with rich, durable powder-coat finish.
- 30 gallon capacity
- Shown with optional liner

- STD13028 YELLOW
- STD13053 RED
- STD13078 GREEN
- STD13083 BLUE
- STD13098 BLACK

LITTER CADDIE LINERS



- Roll them up and snap them open inside to preserve clean, longer-lasting Litter Caddies
- Flexible, black, polypropylene liners are easy to remove for cleaning
- Available in white or orange numbers and letters.
- 9 Gallon Price is for a set of 3
- 20 & 30 Gallon Prices are for a set of 2

- STD13850 9 GALLONS
- STD13870 20 GALLONS
- STD13860 30 GALLONS

LITTER CADDIE COVERS



- Durable polyethylene container top
- Snaps onto 9-, 20- and 30-gallon caddy

- STD13190 9 GALLONS
- STD13090 30 GALLONS

IN-GROUND TRASH CAN

20 and 25 gallon



- Made from galvanized steel, lids are paintable.
- Steel grey in color.
- The foot pedal opens the top to drop it in the garbage.

- PWIG20-2 20 GALLON STEEL GREY
- PWIG25-2 25 GALLON STEEL GREY
- PWIGCCGN POWDER COAT GREEN LID
- PWIGCC POWDER COAT CUSTOM COLOR LID

COLOR OPTION KEY



GREEN BROWN BLACK WAL- GREY

LOGO OPTION KEY



LEXAN ENGRAVED CAST BRONZE CAST ALUMINUM

Call us for more color and logo options. Colors can be combined for two-tone look. Coolers, cup dispensers, trash cans are sold separately unless specified below.

DELUXE WATER COOLER STATION



- RCPWC01-GN HUNTER GREEN
- RCPWC01-BK BLACK
- RCPWC01-BR BROWN
- RCPWC01-BB BLACK W/ BROWN TRIM
- RCPWC01-GB GREEN W/ BLACK TRIM

TRIPOD WATER COOLER STATION



- RCPWC03-GN GREEN
- RCPWC03-BK BLACK
- RCPWC03-BR BROWN

DOUBLE WATER COOLER ENCLOSURE



- RCPWCE-D-GN GREEN
- RCPWCE-D-BK BLACK
- RCPWCE-D-BR BROWN

PAR AIDE WATER PRO ENCLOSURE



- PAR3610 GREEN
- PAR3611 BLACK
- PAR3612 REDWOOD

DELUXE DOUBLE WATER COOLER ENCLOSURE



- RCPWCE-DD-GN GREEN
- RCPWCE-DD-BK BLACK
- RCPWCE-DD-BR BROWN

KOOLER-AID IGLOO WATER STATION

Igloo Cooler & Cup Dispenser Included



- STD45150 GREEN
- STD45170 BLACK
- STD45125 RED

PAR AIDE WATER PRO JR.



- PAR3626 HUNTER GREEN
- PAR3627 BLACK
- PAR3628 REDWOOD

ICE CHEST CABINET WITH TRASH & RECYCLABLES ENCLOSURE



- RCPIC-CTRE-GN GREEN
- RCPIC-CTRE-BK BLACK
- RCPIC-CTRE-BR BROWN

COOLER PRO

Includes 48 Quart Cooler



- PAR3330 HUNTER GREEN
- PAR3331 BLACK
- PAR3332 REDWOOD

LARGE TALL ICE CHEST*

108 Qt & 54 Qt Coolers (162 Quart Total)



- RCPIC-TLG162-GN GREEN
- RCPIC-TLG162-BK BLACK
- RCPIC-TLG162-BR BROWN

MEDIUM TALL ICE CHEST*

108 Quart Cooler



- RCPIC-TMD108-GN GREEN
- RCPIC-TMD108-BK BLACK
- RCPIC-TMD108-BR BROWN

SMALL TALL ICE CHEST*

54 Quart Capacity



- RCPIC-TSM54-GN GREEN
- RCPIC-TSM54-BK BLACK
- RCPIC-TSM54-BR BROWN

*Large, Medium, and Small Tall Ice Chests are also available in low options.

Pricing is subject to change.

TOUCHLESS COOLER SPIGOT



- Attaches to Igloo coolers to allow access to water without the risk of bacteria or virus spread by touching the button.
- 5 inches x 3.5 inches
- Installs easily with no tools needed

GCAHFSPIGOT

IGLOO COOLERS



STD48400 5 GALLON
 STD45400 10 GALLON
 10 gal fits in water cooler stations

REPLACEMENT SPIGOTS



PAR3657-1

SOLO CONE CUPS



STD45650
 4.25 OZ CUPS - CASE OF 5000

REPLACEMENT CUP DISPENSERS



STD45600 DISPENSER

STD45605 TOP ONLY

COOLER COVER LOCKS



STD45700 COOLER COVER LOCK

STD45701 PADLOCK ONLY

FOLDING TRIPOD IGLOO WATER COOLER STAND

Stand Only, Cooler Sold Separately



RCPWC04-GN GREEN

RCPWC04-BR BROWN

RCPWC04-BK BLACK

PORTABLE TOURNAMENT COOLER WITH LOGO

65 Quart & 125 Quart



GCALC65-WH 65 QT. WHITE

GCALC65-TN 65 QT. TAN

GCALC65-BL 65 QT. BLUE

GCALC125-WH 125 QT. WHITE

GCALC125-TN 125 QT. TAN

GCALC125-BL 125 QT. BLUE

CUSTOMIZE YOUR OWN BEVERAGE STATION!



Need a beverage station? All stations can be customized with or without logo, cup and lid dispensers, serving area, drawers and cabinets, and more! Call us for more color options as colors can be combined for two-tone look.

COLOR OPTION KEY



LOGO OPTION KEY



Slats and legs can be customized for the High back Bench, Heritage Bench, Rock Island Bench, and Anchored Mall Bench. Logos and custom memorial plaques can be added to any bench. Call us for more color and logo options.

HIGH BACK BENCH

Customized Color Slats, Leg Color, & Logo



- RCPB-HB4 4-FOOT
- RCPB-HB5 5 FOOT
- RCPB-HB6 6-FOOT

TRADITIONAL TEAK BENCH

6 Foot



- PAR1486 4-FOOT TEAK W/O BACK
- PAR1480 6 FOOT TEAK W/ BACK

HERITAGE CLASSIC BENCH

Customized Color Slats, Leg Color, & Logo



- RCPB-HERB4 4-FOOT
- RCPB-HERB6 6-FOOT

ROCK ISLAND BACK BENCH

Customized Color Slats, Leg Color, & Logo



- STD400200 4-FOOT
- STD400300 6-FOOT

ANCHORED HIGH BACK MALL BENCH

Customized Color Slats, Leg Color, & Logo



- RCPB-AHB4 4-FOOT
- RCPB-AHB6 6 FOOT

CLASSIC HIGH BACK BENCH

5.5 Foot



- PAR620014 GREEN
- PAR620010 BLACK
- PAR620012 BROWN

CURVED BOTTOM MALL BENCH

5 Foot



- PAR620004 GREEN
- PAR620000 BLACK
- PAR620002 BROWN

MALL BENCH



- RCPB-MB4 4-FOOT
- RCPB-MB5 5-FOOT
- RCPB-MB6 6-FOOT

ANCHORED MALL BENCH



- RCPB-AM4 4-FOOT
- RCPB-AM7 7-FOOT

Pricing is subject to change.

COMPRESSED AIR SHOE CLEANER HOUSING



- Blows dirt and grass off shoes with compressed air.
- Traps clippings in an easy-to-remove tray.
- Includes air wand.
- Air-compressor housing sold separately
- Our air compressor is designed to fit perfectly in housing unit.



- RCPSC1-GN** GREEN
- RCPSC1-BK** BLACK
- RCPSC1-BR** BROWN
- PWPCLOGO** ADD LOGO- CALL FOR PRICING

OPTIONAL AIR COMPRESSOR HOUSING UNIT



- STD100199GN** GREEN
- STD100199BK** BLACK
- STD100199BR** BROWN
- PWPCLOGO** ADD LOGO- CALL FOR PRICING



AIR COMPRESSOR

Fits Housing Unit

- MAKMAC700** 110 VOLT AIR COMPRESSOR
- SHPAHCOIL25** COMPRESSOR HOSE
- SHPAFKIT** COMPRESSOR FITTINGS - 5-PIECE



24" AIR BLOW GUN

SHPABGSC



DUO-KLEENER STAND

Standard Golf

- Anchors in asphalt or in turf
- Includes stand, brushes, hardware and mounting spikes

STD36650



REPLACEMENT SPIKE KLEENER BRUSH

Standard Golf



STD14252

PORTABLE SPIKE BRUSH

Par Aide

- Two base brushes and side brushes to thoroughly clean shoes
- Holds steady on hard surfaces with integral rubber pads; spikes available to secure to turf



PAR512-11 GREEN

PAR511-11 BLACK

REPLACEMENT SPIKE BRUSH

Par Aide



PAR554-11

SCRUSHER



STD14100 SCRUSHER

STD14102 REPLACEMENT BOTTOM BRUSH

STD14103 REPLACEMENT SIDE BRUSH

REPLACEMENT SIDE BRUSH

Par Aide



PAR548

RECYCLED LUMBER PODIUMS

RECYCLED LUMBER STARTER PODIUM



- RPCSP2-GN GREEN
- RPCSP2-BK BLACK
- RPCSP2-BR BROWN
- RPCSP2-BB BLACK W/ BROWN TRIM
- RPCSP2-GB GREEN W/ BLACK TRIM

TOURNAMENT PODIUM

Logo & Plain 18" L x 32" W x 46" H



W/LOGO-
NO LOGO-

- RCPP-TL-GN GREEN
- RCPP-TL-BK BLACK
- RCPP-TL-BR BROWN

POIDIUM UMBRELLA BRACKET HOLDERS

- RCPUK-GN GREEN
- RCPUK-BK BLACK
- RCPUK-BR BROWN



COLOR OPTION KEY



GREEN BROWN BLACK WALNUT GREY

LOGO OPTION KEY

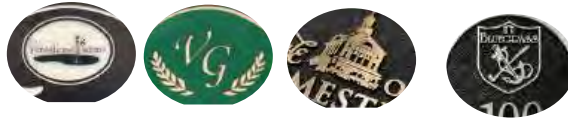

LEXAN ENGRAVED CAST BRONZE CAST ALUMINUM

All podiums and towel stations can be customized with logo or without. Call us for more color options as colors can be combined for two-tone look.

GRAND PODIUM

Logo & Plain - 21" L x 63" W x 47" H



- RCPP-G-GN GREEN
- RCPP-G-BK BLACK
- RCPP-G-BR BROWN

DELUXE PODIUM

Logo & Plain -18" L x 32" W x 46" H



W/LOGO-
NO LOGO-

- RCPP-DL-GN GREEN
- RCPP-DL-BK BLACK
- RCPP-DL-BR BROWN

RECYCLED LUMBER TOWEL STATIONS

TOWEL CENTER W/26 GALLON LINER & SHELVES

19" L x 36.5" W x 45" H



- RCPTWL-SH1G26-GN GREEN
- RCPTWL-SH1G26-BK BLACK
- RCPTWL-SH1G26-BR BROWN

TRIPLE TRASH & TOWEL STATION

26 Gallon liners
72" L x 19" W x 45" H



- RCPTCTS-T26-GN HUNTER GREEN
- RCPTCTS-T26-BK BLACK
- RCPTCTS-T26-BR BROWN

Pricing is subject to change.

COMMERCIAL MARKET UMBRELLAS

9 Foot With Tilt



- High quality fabric - 9 Foot diameter
- 5 year warranty on colorfastness, bleach cleanable, water-repellent but breathable, high-end design
- Aluminum umbrella frame is 20% stronger than most of the umbrellas in the market
- Rust Free Powder Coated with 8 Ribs
- Crank open system - easy to open and close by the crank handle. Press push button to tilt for more shade

GCAUMB-RB	ROYAL BLUE
GCAUMB-RD	BURGUNDY RED
GCAUMB-FG	FOREST GREEN
GCAUMB-BK	BLACK

UMBRELLA BASE



- plastic base fills with sand or water to give it a weight of 50 pounds when full
- lightweight for shipping keeps freight costs low
- handle makes it easy to move

GCAUB



E-Z EVENT SYSTEMS™

At Par West, we're proud to offer EZ-UP, a customized and adaptable system designed to help you stand out at golf course events. Whether you're hosting tournaments, promotional activities, or special events, our EZ-UP solutions provide the perfect platform to increase customer interest and engagement.

REFRESH YOUR TOURNAMENT ACCESSORIES
OR ADD BRAND NEW ONES



TEE DIVIDERS



A-FRAME EASELS



DIRECTORS CHAIRS



6" TABLE COV-



BLADE FLAGS



10' SIDEWALLS

WHY CHOOSE PAR WEST FOR EZ-UP?

Customization: Showcase your brand with personalized canopies, banners, and accessories. Create an environment that reflects your unique identity while drawing attention to your event.

Adaptability: Lightweight, durable, and easy to set up, EZ-UP products are versatile enough to meet the needs of any golf course event, from casual gatherings to formal tournaments.

Professional Appeal: Establish a polished, professional presence that attracts and retains customer attention.

Enhanced Engagement: Create a welcoming and functional space that fosters interaction and leaves a lasting impression.

With Par West's EZ-UP Dealer Solutions, you'll have everything you need to transform your events into unforgettable experiences. Boost visibility, enhance customer interaction, and make your golf course events a resounding success.

CLUBHOUSE FLAGS, AMERICAN FLAGS AND STATE FLAGS



- PW3X5DP** 3' X 5' CUSTOM PRINTED CLUBHOUSE FLAG
- PW3X5STATE** 3' X 5' STATE FLAG
- PW3X5USFLAG** 3' X 5' US FLAG
- PW4X6DP** 4' X 6' CUSTOM PRINTED CLUBHOUSE FLAG
- PW4X6STATE** 4' X 6' STATE FLAG
- PW4X6USFLAG** 4' X 6' US FLAG
- PW5X8CLUBHOUSE** 5' X 8' CUSTOM PRINTED CLUBHOUSE FLAG
- PW5X8STATE** 5' X 8' STATE FLAG
- PW5X8USFLAG** 5' X 8' US FLAG
- PW6X10CLUBHOUSE** 6' X 10' CUSTOM PRINTED CLUBHOUSE FLAG
- PW6X10STATE** 6' X 10' STATE FLAG
- PW6X10USFLAG** 6' X 10' US FLAG

US & state flags are nylon.
clubhouse flags are digital printed logos - single sided



GOLF SCORE CARD PENCILS

- Personalized pencils come in 4 different varieties: hex, hex with eraser, round and round with eraser
- Print up to three lines of your company or course information on the pencils
- Pencil colors: Dark Green, Blue, Red, Cranberry, Black, White, Natural, Maroon
- Also available in - Neon pink, neon yellow, neon green & neon orange.
- Metallic Imprint color options - (Metallic) Gold, Silver, Red, Blue, Green, Copper, Purple, Metallic Green
- Non-Metallic Imprint color options - Black, White

ROUND WITH ERASER



- DRERPE-L** PRINTED LOGO
25 GROSS (3600 PENCILS)
- * 25 gross minimum order. Art set-up fees may apply

HEX WITH ERASER



- DREHPE** PRINTED LOGO
25 GROSS (3600 PENCILS)
- * 25 gross minimum order. Art set-up fees may apply

ROUND NON ERASER

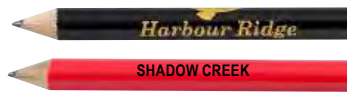

- DRERP-L** PRINTED LOGO
25 GROSS (3600 PENCILS)
- * 25 gross minimum order. Art set-up fees may apply

HEX NON ERASER



- DREHP-L** PRINTED LOGO
25 GROSS (3600 PENCILS)
- * 25 gross minimum order. Art set-up fees may apply

PLAIN GOLF PENCILS



- DRERPE** ROUND W/ERASER
- DREHPE** HEX W/ ERASER
- DRERP** ROUND
- DREHP** HEX

- Prices are per gross (144 per gross)
- Available in red, green, black or blue
- Discounts available for large orders

PROXIMITY MARKERS

With Paper Sheets



- DREPM** MARKER SET (4)
- DREPM-25** REPLACEMENT CARDS (25 PACK)

PROXIMITY MARKERS

Reusable / Dry Erase



- PAR10600** PROXIMITY MARKER
- PAR10602** CONTEST INDICATOR
- PAR10620** CUSTOM PROXIMITY MARKER
- PAR10622** CUSTOM CONTEST INDICATOR

Erasable (no paper)
Can be customized

LONG DRIVE MARKEER

NEW PRODUCT!



- Comes standard with clipboard and base
- Flag not included
- Made with our Perma-Core Plastic

PWLDD-C-COLOR



CLOSEST TO THE PIN



- Comes standard with 25 cards
- Comes with 50' tape measure

GCACPM MEASURING MARKER KIT

GCACPMS REPLACEMENT CARDS (25 PACK)

NEW PRODUCT!



PERMA-CORE CLOSEST TO THE PIN
Measuring Tape & Handle



- Comes standard with 25 cards
- Comes with 50' tape measure
- Made with our Perma-Core Plastic

PWPCCPM-C-COLOR MEASURING MARKER KIT

Use Our Perma-Core Color Option Key To Choose Your Color for Long Drive and Closest to the Pin Markers!

BAG TAGS

- Molded from high impact styrene.
- Colors available: white, black, red, light blue, dark blue, beige, gray, green, yellow and orange
- Choose from styles below
- Extra side or extra colors in logo will have additional costs

	PART #	DESCRIPTION
A	DREBT275	2" X 3 1/2" RECTANGLE WITH NAME SLOT AT BOTTOM
B	DREBT350	3 1/2" ROUND TAG WITH NAME CHANNEL
C	DREBT462	4 1/2" FLEXIBLE GUEST TAG WITH BUILT IN STRAP
D	DREBT450	2 7/8" X 3 5/8" SHIELD TAG
E	DREBT385	3 1/2" SQUARE TAG WITH NAME CHANNEL
F	DREBT400	3 1/4" X 3 1/2" TRAPEZOID WITHOUT NAME CHANNEL
G	DREBT475	5" X 3 3/4" INCH TAG
H	DREBT490	5 1/2 X 4 INCH DIAMOND WITH TWO NAME CHANNELS
I	DREBT495	DIAMOND TAG
J	DREBT480	3 1/2 X 3 7/8 INCH TAG
K	DREBT485	3 1/2 X 4 1/2 INCH RECTANGLE
L	DREBT375	3 1/4" X 4" OVAL TAG WITH NAME CHANNEL



CLOCK EASEL- ECONOMY

24" Tall x 16" Wide

- Perma core plastic easel with clock included
- Add logo for extra charge



PWPC-CE-SS- _ SINGLE SIDED
 PWPC-CE-DS- _ DOUBLE SIDED

CLOCK EASEL- DELUXE

32" Tall x 24" Wide

- Perma core plastic easel with clock included
- Add logo for extra charge



PWPCDCE-SS- _ SINGLE SIDED
 PWPCDCE-DS- _ DOUBLE SIDED

EASEL COLOR OPTION KEY



CLUBHOUSE AND STARTER SIGNS WITH CLOCKS



- Available in 12 color options
- Can be mounted to a post, hung from metal post, or mounted to wall.
- Mounting sold separately.
- Messages can be modified to fit your needs
- Add color option to end of part number

PWPC1424SC-S11_ 14" X 24" PLEASE KEEP PACE OF PLAY - SHAPE 11
 PWPC1424SC-S4_ 14" X 24" PLEASE KEEP PACE OF PLAY - SHAPE 4
 PWPC1424SCS-S2_ 14" X 24" TODAY'S COURSE RULES W/ SLIDERS- SHAPE 2
 PWPC2436SCS-S2_ 24" X 36" TODAY'S COURSE RULES W/ SLIDERS- SHAPE 2

COLOR OPTION KEY

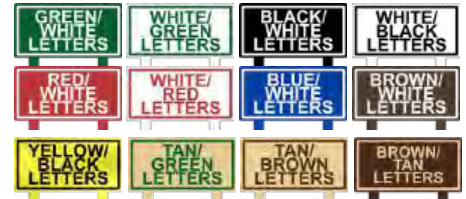

RECYCLED PLASTIC MOUNTING POST OPTIONS

5, 6, 7, Or 8 Feet Options

- Black, White, Brown, and Green Options Available.
- 4 inch x 4 inch material
- Great for starter signs

RCPPPOST4460- _ 5' POST
 RCPPOST4472- _ 6' POST
 RCPPOST4484- _ 7' POST
 RCPPOST4496- _ 8' POST



See other sign post options on page 26!



CLOCKS ONLY

STD200900 WHITE, 12" - OUTDOOR WATER RESISTANT
 STD200902 ATOMIC SILVER, 18" - OUTDOOR WATER RESISTANT
 STD200901 BROWN, 15"

Pricing is subject to change.



PAR WEST EXCLUSIVE

3/4" TAPERED FLAGSTICK

PREMIUM PRACTICE GREEN FLAGSTICKS

- 1/2" Fiberglass pole or tournament tapered 3/4"
- 30" Tall
- Available in solid or striped colors
- Durable metal base
- Includes top knob
- Custom sizes & colors available

Solid colors - white, yellow black or pink

Striped colors - white/black, white/red, white/blue or yellow/black

- PWPGS-__** WHITE OR YELLOW SOLID
- PWPGSS-__** STRIPED/OTHER SOLID
- PWPGST-__** TAPERED SOLID COLOR
- PWPGSST-__** TAPERED STRIPED



PREMIUM CUPLESS PRACTICE GREEN FLAGSTICKS

- 1/2" Fiberglass pole or tournament tapered 3/4"
- 30" Tall
- Available in solid or striped colors
- Durable metal spike
- Includes top knob
- Custom sizes & colors available

Solid Colors - White, Yellow
Striped Colors - Red/White, Black/White, Blue/White Or Green/White



- PWPGSC-__** WHITE OR YELLOW SOLID
- PWPGSSC-__** STRIPED/OTHER SOLID

LIGHTED PRACTICE GREEN STICKS

Rechargeable Battery Operated

- One charger will do up to five sticks
- 1/2" Acrylic pole - 30" tall
- Run time of about 2 hours
- Charger Sold Separately

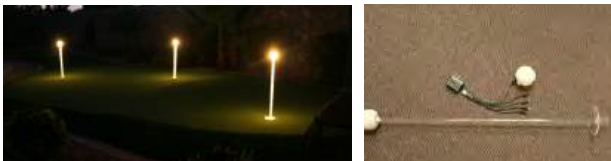

- GCAGBT3500** WHITE COLOR STICK
- GCAGBT3000** CHARGING UNIT



PAR WEST EXCLUSIVE

IPE HARDWOOD PRACTICE GREEN FLAGSTICKS

- Unmatched strength
- Natural resistance- ipe's natural properties ensure your investment lasts for years to come.
- Superior construction
- Practical design
- Long-lasting finish
- Ipe hardwood poles come with a bronze base and either have a flag or our custom bronze top with an etched logo.
- Choose either a black aluminum or brass fittings.

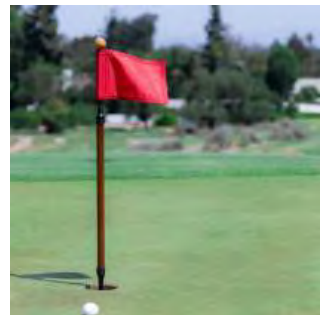

- PWPGW** FLAGSTICK W/ BLACK FITTING
- PWPGW-B** FLAGSTICK W/ BRASS FITTING
- PC-PGH-35-AL** BRONZE 3" HEAD ONLY

PRACTICE GREEN POLE KNOBS



- PWTKR** ROUND KNOB
- PWTKT** T HANDLE KNOB
- PAR9099-9** BALL KNOB (PACK OF 9)

PERMA CORE NUMBERED PRACTICE GREEN POLE TOPS

Circle & Flag Options

- CIRCLE TOP- 4" circle diameter with raised numbers in center
- FLAG TOP - 6" by 3.5" with raised numbers in center
- No fading or paint chipping - these last forever
- Add number you want to end of part number
- 3/4 inch thick - USA made laminate plastic with tapped threads
- All heads can also be compatible with IPE Hardwood Practice Green

PWPCPGND-1- CIRCLE POLE TOP

PWPCPGFND- FLAG POLE TOP

*See page 64 for more practice stick options.

PERMA CORE LOGO DECAL PRACTICE GREEN POLE TOPS

Circle & Flag Options

- CIRCLE TOP- 4" circle diameter with logo decal
- FLAG TOP - 6" by 3.5" with logo decal
- No fading or paint chipping - these last forever
- 3/4 inch thick - USA made laminate plastic with tapped threads
- All heads can also be compatible with IPE Hardwood Practice Green Flagstick

PWPCPLD-1 DECAL CIRCLE POLE TOP

PWPCPGFLD-1 DECAL FLAG POLE TOP

*See page 65 for more practice stick options.

COLOR OPTION KEY



PRACTICE GREEN MARKERS

Numbered



Flags not included

- Create numbered holes on the practice green
- Includes 3/8" rod, metal base, aluminum top and number decal
- Vinyl decals are weatherproof
- Double-sided
- Same color options as the logo markers
- Numbers can be black, red, white, yellow, green or blue

PWPGN

PRACTICE GREEN MARKERS

Personalized With Logo

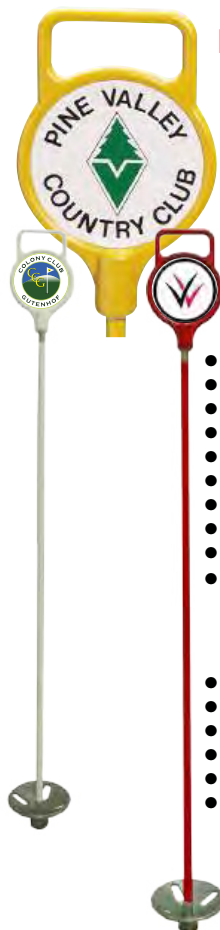

- Brand your practice green markers with your logo
- Includes 3/8" rod, metal base, Aluminum top and logo decal
- Vinyl decals are weatherproof
- Double sided logo
- No art set up fees for logo

ROD COLOR OPTIONS

- White
- Red
- Black
- Yellow
- Blue
- Green
- Black/White striped - add \$3.00
- White/Red striped - add \$3.00
- Yellow/Black striped - add \$3.00
- Green/white striped - add \$3.00

TOP COLOR OPTIONS

- White
- Yellow
- Red
- Green
- Blue
- Black

PWPGL

WOOD GRAIN CAST ALUMINUM MARKER



NEW PRODUCT!

- Resiliency and functionality of cast aluminum, now with painted, wood-grain appearance
- Plain or personalized with sets of numbers or your club logo
- Pairs well with Wood Grain 3/8" Practice Green Rods

STD20531 HEAD ONLY

STD20523 BLACK METAL BASE

Pricing is subject to change.

TOURNAMENT PRACTICE GREEN FLAGSTICKS



- PAR9110 WHITE
- PAR9111 YELLOW
- PAR9112 RED/WHITE
- PAR9113 BLACK/WHITE
- PAR9114 GREEN/WHITE
- PAR9115 BLACK/YELLOW

1/2 INCH PRACTICE GREEN FLAGSTICKS



- PAR9190 WHITE
- PAR9191 YELLOW
- PAR9192 RED/WHITE
- PAR9193 BLACK/WHITE
- PAR9194 GREEN/WHITE
- PAR9195 BLACK/YELLOW

WOODEN PRACTICE GREEN FLAGSTICKS



Flags not included

- PAR9121 BASE W/ TOP KNOB
- PAR9121-2 CUPLESS W/ TOP KNOB
- PAR9120 REGULAR TOP
- PAR9120-2 CUPLESS W/ REGULAR TOP
- PAR9098-9 WOODEN KNOB (PACK OF 9)

ALUMINUM PRACTICE GREEN CUP



STD18150

4" PLASTIC PRACTICE GREEN CUPS



STD18100



PAR940

PUSH N' PUTT PRACTICE GREEN FLAGSTICK



PUSH DOWN ON FLAG KNOB TO EJECT BALLS FROM CUP



- Reduces bending over to retrieve golf balls that fall back into the cup
- Ideal for golf pros teaching putting skills or lessons

Flags are not included and are sold separately.

PWPGS-PD

SURE PUTT PRACTICE SYSTEM



- Widely regarded as the finest putting aid for any level of golfer
- Putting to the smaller cup, 3 in. diameter compared to a regulation cup helps focus aim
- System comes with 3 cups, cup cutter and sign

PAR10710 SURE PUTT SYSTEM

PAR10702 METAL 2" CUPS

STANDARD GOLF HOLE REDUCER



- Sits on top of a recessed cup to be flush with the green
- Reduced cup opening by 1" (2.5 cm)
- Helps players fine-tune putting skills
- Ideal for practice greens, or coaches / instructors to place on the course greens for advanced player practice
- Made from a synthetic polymer for a lighter and more durable construction

STD18010

PERSONALIZED ROUTED BLOCK TEE MARKERS

Includes Decals

NEW PRODUCT!

- Routed to fit custom domed resin decals (included)
- Spike is placed for a square, cubed look
- Minimum order of 36



- STD100050 RED
- STD100051 WHITE
- STD100052 BLUE
- STD100053 YELLOW
- STD100055 BLACK
- STD100059 GREEN
- STD20450 CUSTOM DECAL ONLY

PREMIUM LASER CUT TEE MARKERS

Thick-Cut Stainless Steel Build

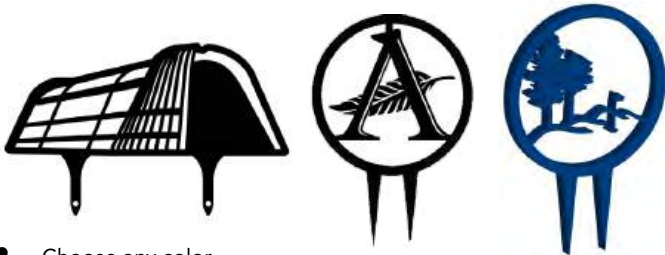

- Choose any color
- Our in house artist will help convert your logo into a laser cut design at no charge
- Durable, low maintenance and affordable
- Most designs will fall into our common size price below, but we will give you a quote if you have a more complicated design
- Normal dimensions are 4" wide x 8" tall

GCALCTM COMMON SIZES AND DESIGNS

ECONOMY LASER CUT TEE MARKERS

Thin-Cut Stainless Steel Build

NEW PRODUCT!

- Made of high quality stainless steel in a single color powder coated finish
- 10.5" height, custom laser cut design fits 6"x 6" diameter
- Minimum order of 18



- STD05900 RED
- STD05901 WHITE
- STD05902 BLUE
- STD05903 YELLOW
- STD05904 BLACK
- STD05905 GOLD
- STD05906 ORANGE
- STD05907 GREEN
- STD05908 PURPLE
- STD05909 CUSTOM COLOR

CAST ALUMINUM & BRONZE TEE MARKERS



- Cast aluminum & bronze tee markers are made with the highest quality standards.
- All markers include two 4" stainless steel mounting spikes.
- Choose the background color and texture that best combines with your logo and needs.

STEP 1 - CHOOSE YOUR MATERIAL

CAST ALUMINUM

CAST BRONZE



STEP 2 - CHOOSE YOUR SIZE & SHAPE

SIZE ALUMINUM BRONZE

4" X 6"

5" X 7"

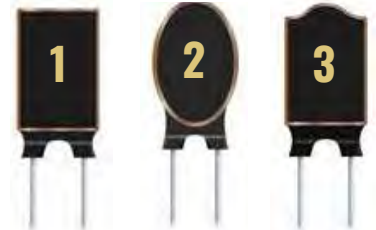

SIZE ALUMINUM BRONZE

6" X 4"

7" X 5"



SIZE ALUMINUM BRONZE

5"

6"



Available in round or square

Pricing is subject to change.

FORE-EVER TEE MARKERS

3" & 4" Sizes with Neck or Round Style

- One of our most popular and most economical tee markers from courses on both ends of the budget spectrum
- Made from a special blend of resins
- Incredibly durable with a mirrored finish
- UV stable and will never need painting
- Three sizes available - contact us for 5 inch part numbers
- Fitted with a stainless steel spike
- Add an engraved logo for extra charge per marker



4 INCH 3 INCH



ROUND STYLE



NECK STYLE

3" - 4" -



RED



WHITE



BLUE



ROUND

NECK

ROUND

NECK

ROUND

NECK

GCAEVR-3-RD

GCAEVN-3-RD

GCAEVR-3-WH

GCAEVN-3-WH

GCAEVR-3-BL

GCAEVN-3-BL

GCAEVR-4-RD

GCAEVN-4-RD

GCAEVR-4-WH

GCAEVN-4-WH

GCAEVR-4-BL

GCAEVN-4-BL



YELLOW



HUNTER GREEN



ORANGE

CUSTOMIZE YOUR OWN FORE-EVER TEE MARKER!

ROUND

NECK

ROUND

NECK

ROUND

NECK

GCAEVR-3-YW

GCAEVN-3-YW

GCAEVR-3-HG

GCAEVN-3-HG

GCAEVR-3-OR

GCAEVN-3-OR

GCAEVR-4-YW

GCAEVN-4-YW

GCAEVR-4-HG

GCAEVN-4-HG

GCAEVR-4-OR

GCAEVN-4-OR



Call us for a quote to add your logo to our Fore-Ever Tee Marker above at additional cost.



BLACK



METALLIC GOLD



GREY

ROUND

NECK

ROUND

NECK

ROUND

NECK

GCAEVR-3-BK

GCAEVN-3-BK

GCAEVR-3-MG

GCAEVN-3-MG

GCAEVR-3-GY

GCAEVN-3-GY

GCAEVR-4-BK

GCAEVN-4-BK

GCAEVR-4-MG

GCAEVN-4-MG

GCAEVR-4-GY

GCAEVN-4-GY

RE-NEW-A-TEE

Resin Tee Marker Renewal Kit

PAR635600 2 PART KIT



- Restore your Fore-Ever Marked Tee Markers to their original high gloss finish
- Two part clear coat epoxy kit
- Simply sand, clean and dip into epoxy and let dry overnight
- Restores approximately 172 4" Tee Markers

PERMA CORE TEE MARKERS

PERMA CORE SHOWCASE TEE MARKERS WITH LOGO



SINGLE-SIDED -
PWPCTMSH-__

DOUBLE-SIDED -
PWPCTMSHD-__

PERMA CORE DOME TEE MARKERS WITH LOGO



SINGLE-SIDED-
PWPCTMD-__

DOUBLE-SIDED-
PWPCTMDD-__

TEE MARKER COLOR OPTION KEY

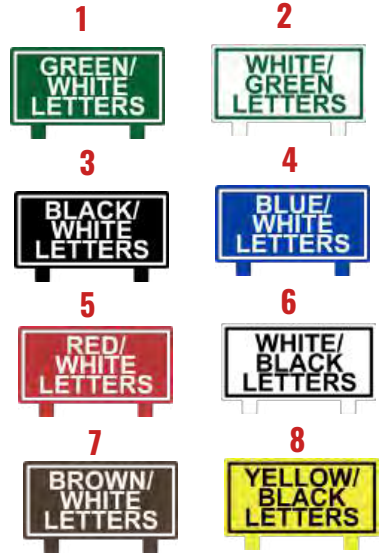

PERMA CORE SHIELD TEE MARKERS WITH LOGO



SINGLE-SIDED-
PWPCTMS-__

DOUBLE-SIDED-
PWPCTMSD-__

PERMA CORE LOLLIPOP LOGO TEE MARKERS



SINGLE-SIDED-
PWPCTML-__

DOUBLE-SIDED-
PWPCTMLD-__

PERMA CORE LOLLIPOP NUMBERED TEE MARKERS



SINGLE-SIDED-
PWPCTMN-__

DOUBLE-SIDED-
PWPCTMND-__

PERMA-CORE ECONOMY LAMINATE TEE MARKER



- PWPCTME-5 RED
- PWPCTME-2 WHITE
- PWPCTME-4 BLUE
- PWPCTME-8 YELLOW
- PWPCTME-3 BLACK
- PWPCTME-1 GREEN



Pricing is subject to change.

DOGWOOD BRANCH TEE MARKER



Add logo for extra charge. See below.

- PAR632-1 RED
- PAR632-2 WHITE
- PAR632-3 BLUE
- PAR632-4 YELLOW
- PAR632-5 BLACK
- PAR632-6 GREEN
- PAR632-7 GOLD

PINE BRANCH TEE MARKER



Add logo for extra charge. See below.

- PAR630-1 RED
- PAR630-2 WHITE
- PAR630-3 BLUE
- PAR630-4 YELLOW
- PAR630-5 BLACK
- PAR630-6 GREEN
- PAR630-7 GOLD

OAK WOOD TEE MARKER



- STD05620 RED
- STD05621 WHITE
- STD05622 BLUE
- STD05623 YELLOW
- STD05624 BLACK
- STD05625 GOLD
- STD05626 ORANGE
- STD05627 GREEN
- STD05628 PURPLE

WEDGE TEE MARKER



Add logo for extra charge. See below.

- STD05150 RED
- STD05151 WHITE
- STD05152 BLUE
- STD05153 YELLOW
- STD05155 BLACK

PERSONALIZED DIMPLE TEE MARKER



Add logo for extra charge. See below.

- STD05270 RED
- STD05271 WHITE
- STD05272 BLUE
- STD05273 YELLOW
- STD05275 BLACK
- STD05276 SILVER
- STD05277 GOLD
- STD05278 ORANGE
- STD05279 GREEN

CAST ALUMINUM TEE MARKER



Add logo for extra charge. See below.

- STD05750 RED
- STD05751 WHITE
- STD05752 BLUE
- STD05753 YELLOW
- STD05755 BLACK
- STD05759 GREEN

ADD YOUR LOGO

- Purchase one logo for the Personalized Dimple Tee Marker and Wedge Tee Marker.
- Purchase two logos for Dogwood Branch, Pine Branch, and Cast Aluminum Tee Markers to have a double sided logo tee marker
- Logo will either be digital printed vinyl or hand cut vinyl depending on your logo style
- Free artwork!

CROWN ALUMINUM TEE MARKER



- STD05700 RED
- STD05701 WHITE
- STD05702 BLUE
- STD05703 YELLOW
- STD05705 BLACK
- STD05709 GREEN
- STD05710 PINK

STRUCTURED TEE MARKER



- STD100020 RED
- STD100021 WHITE
- STD100022 BLUE
- STD100023 YELLOW
- STD100024 BLACK
- STD100029 GREEN

TOWER TEE MARKER



- STD100040 RED
- STD100041 WHITE
- STD100042 BLUE
- STD100043 YELLOW
- STD100045 BLACK
- STD100049 GREEN

DIMPLE TEE MARKER



- STD05250 RED
- STD05251 WHITE
- STD05252 BLUE
- STD05253 YELLOW
- STD05255 BLACK
- STD05256 SILVER
- STD05257 GOLD
- STD05258 ORANGE
- STD05259 GREEN

CLASSIC TEE MARKER



- STD05600 RED
- STD05601 WHITE
- STD05602 BLUE
- STD05603 YELLOW
- STD05604 BLACK
- STD05605 ORANGE
- STD05606 GREEN

CUBE TEE MARKER



- PAR633701 RED
- PAR633702 WHITE
- PAR633703 BLUE
- PAR633704 YELLOW
- PAR633705 GREEN
- PAR633706 BLACK



MASTER BALL WASHER



- PAR205-01 PAR AIDE RED
- PAR205-02 HUNTER GREEN
- PAR205-00 BLACK
- PAR205-99 SPECIFY COLOR

MASTER ENSEMBLE



- PAR50-** MASTER ENSEMBLE (NO TRASH)
- PAR51-** MASTER ENSEMBLE W/ SINGLE TRASH MATE
- PAR52-** MASTER ENSEMBLE W/ DOUBLE TRASH MATE

**CHOOSE COLORS RED (-01), GREEN (-02), BLACK (-00) OR CUSTOM (-99)

DELUXE BALL WASHER



- PAR203-01 PAR AIDE RED
- PAR203-02 HUNTER GREEN
- PAR203-00 BLACK
- PAR203-99 SPECIFY COLOR

DELUXE ENSEMBLE



- PAR30-** DELUXE ENSEMBLE (NO TRASH)
- PAR31-** DELUXE ENSEMBLE W/ SINGLE TRASH MATE
- PAR34-** DELUXE ENSEMBLE W/ DOUBLE TRASH, SPIKE BRUSH & CLUB WASHER

**CHOOSE COLORS RED (-01), GREEN (-02), BLACK (-00) OR CUSTOM (-99)





- PAR200-10
- PAR200-30
- PAR200-21-4
- PAR203-25
- PAR205-25
- PAR203-70-6
- PAR200-20
- PAR200-60-4
- PAR203-40-4
- PAR203-50-10
- PAR200-80-4
- PAR204-70-6
- PAR200-11-4
- PAR203-10-4
- PAR203-16-4

BALL WASHER PARTS

Par Aide

BALL WASHER PARTS

- BALL WASHER REPAIR KIT
- AGITATOR ASSEMBLY
- CAP SCREW
- FOAM GASKET (DELUXE)
- FOAM GASKET (MASTER)
- COVER LOCKING SCREW
- BRUSH ASSEMBLY
- TOWEL CLIP (PACK OF 4)
- DRAIN PLUG (PACK OF 4)
- DRAIN GASKET (PACK OF 10)
- AGITATOR LOCK NUT (PACK OF 4)
- BASE LOCK SCREW (PACK OF 6)
- AGITATOR GROMMET (PACK OF 4)
- DRAIN PLUG WRENCH (PACK OF 4)
- ALLEN WRENCH (PACK OF 4)

BALL WASHER REPAIR KIT

Par Aide

BALLWASHER REPAIR KIT INCLUDES:

- Agitator assembly
- Cap screw
- Foam gasket
- Cover locking screw
- Brush assembly
- Towel clip
- Drain plug
- Drain gasket

PAR200-10



CLASSIC BALL WASHER



- Crank-style washer with four-ball capacity
- Free engraving on orders of 9 or more when using the same logo

- STD01325 RED
- STD01350 GREEN
- STD01370 BLACK
- STD01300 YELLOW
- STD01340 BROWN
- STD01375 BLUE
- STD01395 WHITE

MOUNTING PIPE



- Aluminum pipe will not rust
- Powder coated finish
- 2.75 inch outside diameter
- 40 inch post for permanent mounting in the ground or in concrete
- 34 inch post for use with portable base

- PAR210-00 BLACK - 34"
- PAR210-02 GREEN - 34"
- PAR211-00 BLACK - 48"
- PAR211-02 GREEN - 48"

BALL WASHER BRACKET

Mount Ball Washer to Flat Surface



PAR215-00

PORTABLE BASE



- PAR310-01 PAR AIDE RED
- PAR310-02 HUNTER GREEN
- PAR310-00 BLACK

SINGLE PIPE MOUNT SPIKE BRUSH



PAR552-11

FLOOR MOUNT SPIKE CLEANER



- PAR549-11 SPIKE & SHOE CLEANER
- PAR554-11 REPLACEMENT BOTTOM BRUSH
- PAR548 REPLACEMENT SIDE BRUSH

SCRUSHER



- STD14100 SCRUSHER
- STD14102 REPLACEMENT BOTTOM BRUSH
- STD14103 REPLACEMENT SIDE BRUSH

SPIKE KLEENER



- STD14750 BLACK
- STD14252 REPLACEMENT BRUSH

TRASH MATE CONTAINERS AND PARTS



- PAR3014-00 CONTAINER ONLY - BLACK
- PAR3014-01 CONTAINER ONLY - RED
- PAR3014-02 CONTAINER ONLY - GREEN
- PAR3014-03 CONTAINER ONLY - BLUE
- PAR3010 LID ONLY - "CANS ONLY"
- PAR3011 LID ONLY - TRASH
- PAR3012 LID ONLY - SOLID
- PAR3005-00 TRASH MATE W/ MOUNT- BLACK
- PAR3005-01 TRASH MATE W/ MOUNT - RED
- PAR3005-02 TRASH MATE W/ MOUNT - GREEN
- PAR3005-03 TRASH MATE W/ MOUNT - BLUE
- PAR3030 TRASH MATE LOW STAND
- PAR3031 TRASH MATE IN GROUND STAND



9 GALLON TAPERED LITTER CADDIE



- STD13400 YELLOW WITH SPIKE
- STD13150 RED WITH SPIKE
- STD13152 RED WITH BASE
- STD13700 GREEN WITH SPIKE
- STD13800 GREEN WITH BASE
- STD13175 BLUE WITH SPIKE
- STD13177 BLUE WITH BASE
- STD13195 BLACK WITH SPIKE
- STD13197 BLACK WITH BASE
- STD13199 CUSTOM LOGO

30 GALLON TAPERED LITTER CADDIE



- STD13050 RED WITH SPIKE
- STD13053 RED WITH BASE
- STD13075 GREEN WITH SPIKE
- STD13078 GREEN WITH BASE
- STD13080 BLUE WITH SPIKE
- STD13083 BLUE WITH BASE
- STD13095 BLACK WITH SPIKE
- STD13098 BLACK WITH BASE

*20 gallon option available. See page 54 for little caddy liners and cover options.

MICROFIBER TEE TOWELS

18"H x 6"W Tri-Fold

- Seven times the absorbency and three times the wicking power of cotton.
- Stain-, odor- and UV-resistant.
- Microfiber stays cleaner longer, dries faster, requires less maintenance.
- You can embroider them with your club logo.
- Priced per dozen



- STD04500 BLACK
- STD04503 GREEN
- STD04290 ADD LOGO EMBROIDERY
- STD20990 LOGO TAPE SET-UP CHARGE

PREMIUM VELOUR TEE TOWELS

Tri-Fold Or Corner Grommet

- Ultra premium velour
- 16" X 26"
- Includes hanging clip
- Longer size great for adding logo



- GCATT-BK BLACK
- GCATT-GR GREEN
- GCATT-BR BROWN
- GCATT-NB NAVY BLUE
- GCATT-WH WHITE
- GCATT-RD RED
- GCATT-BU BURGUNDY

TERRY VELOUR TEE TOWELS

UV Sunlight Resistant

- Great value!
- 15" X 18"
- Includes hanging clip
- Choose from black or green
- Tri-fold or corner grommet
- Uv resistance lasts 3-4 times longer than regular towel
- Pack of 12



GCATTUV

PREMIUM DISPOSABLE TEE TOWELS



- GCATTG GREEN (CASE OF 200)
- GCATTB BLACK (CASE OF 200)

COTTON TEE TOWELS

Tri-Fold



- PAR403 GREEN (DOZEN)
- PAR404 GREEN 12 DOZEN (CASE)
- PAR405 BLACK (DOZEN)
- PAR406 BLACK 12 DOZEN (CASE)

GREEN COTTON TEE TOWELS

Corner Grommet



- PAR403-2 PER DOZEN
- PAR404-2 12 DOZEN (CASE)



VALUE TEE TOWELS

- Microfiber constructed towel.
- Machine washable.
- Priced per dozen

- STD04511 BLACK
- STD04510 GREEN



ECONOMY DISPOSABLE TEE TOWELS

- STD04969 CASE OF 200 GREEN & WHITE

TOWEL CLIP



- PAR200-60-4 4-PACK

BALL WASHER SOAP

PAR AIDE BALL WASHER DETERGENT

Lemon Scented



- PAR4102 5 LB. CARTON TABLETS
- PAR4110 1 GAL LIQUID
- PAR4112 4 GAL CASE
- PAR4103 CASE OF 4 CARTON TABLETS

SPARKLEEN LIQUID SOAP

Case Of (4) 1 Gallon Jugs



STD03300

SPARKLEEN ECOMAX

TABLETS

450 Count Jar



STD03100

Pricing is subject to change.

RECYCLED BROKEN TEE CADDIE



- PAR3490 GREEN
- PAR3492 REDWOOD
- PAR3491 BLACK

BROKEN TEE CADDIE

- Sleek cone-shaped design
- Powder-coated steel
- 6" high w/ 5" spike

- STD19000 BLACK
- STD19015 YELLOW
- STD19025 RED
- STD19050 GREEN
- STD19075 BLUE
- STD19085 ORANGE
- STD19095 WHITE



DIMPLE-T BROKEN TEE CADDIE

- 5" Diameter w/ 4.5" spike

- STD05280 RED
- STD05281 WHITE
- STD05282 BLUE
- STD05283 YELLOW
- STD05285 BLACK
- STD05286 SILVER
- STD05287 GOLD
- STD05288 ORANGE
- STD05289 GREEN



OAK BROKEN TEE CADDIE

- Customizable stripe with color and logo available - minimum order of 36 minimizes footprint
- Priced individually, sold in sets of 2.
- 4.25" H x 4" W w/ 3.5" spike



- RED STD05520
- WHITE STD05521
- BLUE STD05522
- YELLOW STD05523
- BLACK STD05524
- GOLD STD05525
- ORANGE STD05526
- GREEN STD05527
- PURPLE STD05528

COLOR OPTION KEY



Call Us For More Color Options. Color options only available for scorecard caddies below.

PRESIDENTIAL SCORECARD CADDIE

4"x 4" x 60" Post



- RCPSCC-P-GN GREEN
- RCPSCC-P-BR BROWN
- RCPSCC-P-BK BLACK

EXCLUSIVE SCORECARD CADDIE

4"x 4" x 60" Post



- RCPSCC-E-GN GREEN
- RCPSCC-E-BR BROWN
- RCPSCC-E-BK BLACK

SCORECARD CADDIE ON 5" POST

4"x 4" x 60" Post



- RCPSCC-5-GN GREEN
- RCPSCC-5-BR BROWN
- RCPSCC-5-BK BLACK

SCORECARD CADDIE W/PORTABLE BASE

4"x 4" x 60" Post



- RCPSCC-PB-GN GREEN
- RCPSCC-PB-BR BROWN
- RCPSCC-PB-BK BLACK

SCORECARD CADDY

4"x 4" x 52" Post



- The Scorecard Caddy makes organization simple and interchangeable with your course.
- Interchangeable dividers allow for custom organization of scorecards of all sizes, tees, pencils, ball makers and ball mark repair tools

- PAR3358 GREEN W/ 52" GREEN POST
- PAR3359 GREEN W/ 52" BLACK POST
- PAR3360 BLACK W/ 52" BLACK POST
- PAR3361 REDWOOD W/ 52" BLACK POST
- PAR3358-2 GREEN CADDY ONLY
- PAR3358-0 BLACK CADDY ONLY
- PAR3358-11 REDWOOD CADDY ONLY



COLOR OPTION KEY



GREEN BROWN BLACK WALNUT GREY

Call us for more color, logo, & caster options

LOGO OPTION KEY



LEXAN ENGRAVED CAST BRONZE CAST ALUMINUM

RECYCLED LUMBER DIVOT MIX BOTTLE RACK

Holds 24 Bottles



NO HANDLE SLOTS

SLOTS FOR HANDLE

HUNTER GREEN

RCPDBR24-GN

RCPDBR24H-GN

BROWN

RCPDBR24-BR

RCPDBR24H-BR

BLACK

RCPDBR24-BK

RCPDBR24H-BK

Call us for availability for portable option with feet

DOUBLE DIVOT MIX BOTTLE HOLDER

Holds 30 Bottles



RCPDMBH-D-GN

GREEN

RCPDMBH-D-BK

BLACK

RCPDMBH-D-BR

BROWN

DOUBLE DECK DIVOT MIX BOTTLE HOLDER

Holds 30 Bottles



RCPDMBH-DD-GN

GREEN

RCPDMBH-DD-BK

BLACK

RCPDMBH-DD-BR

BROWN

PREMIUM BOTTLE STORAGE BOX

30" L x 32" W x 23" H



RCPDBB25-GN

HUNTER GREEN

RCPDBB25-BR

BROWN

RCPDBB25-BK

BLACK

RCPDBB25-BB

BLACK W/ BROWN TRIM

RCPDBB25-GB

GREEN W/ BLACK TRIM

SINGLE DIVOT MIX BOTTLE HOLDER

Holds 15 Bottles



RCPDMBH-S-GN

GREEN

RCPDMBH-S-BK

BLACK

RCPDMBH-S-BR

BROWN

RAISED & PORTABLE DIVOT MIX BOX

Holds 24 Bottles



RCPDMB-RP-GN

GREEN

RCPDMB-RP-BK

BLACK

RCPDMB-RP-BR

BROWN

SMALL DIVOT BOTTLE BOX

Holds 12 Bottles



RCPDBB-SM-GN

GREEN

RCPDBB-SM-BK

BLACK

RCPDBB-SM-BR

BROWN

SMALL DIVOT BOTTLE CADDIE

Holds 12 Bottles



RCPDBC-SM-GN

GREEN

RCPDBC-SM-BK

BLACK

RCPDBC-SM-BR

BROWN

DIVOT BOTTLE FAIRWAY CADDIE

Laser Cut Metal



DRESBH-BK

BLACK

DRESBH-GN

GREEN

TEE SEED & SOIL CADDIE

With Holder



STD18800

BLACK

STD18900

HUNTER GREEN

Pricing is subject to change.

COLOR OPTION KEY



GREEN BROWN BLACK WALNUT GREY

Call us for more color & logo options

LOGO OPTION KEY



LEXAN ENGRAVED CAST BRONZE CAST ALUMINUM

XL DIVOT MIX SAND & SEED STORAGE BOX

19" L x 21" W x 28" H



- RCPDMB-XL-GN GREEN
- RCPDMB-XL-BK BLACK
- RCPDMB-XL-BR BROWN

ANGLE RAISED MIX STORAGE BOX

22" L x 15" W x 27" H



- RCPDMC-RAS-GN GREEN
- RCPDMC-RAS-BK BLACK
- RCPDMC-RAS-BR BROWN

SQUARE DIVOT MIX CONTAINER

5 Gallon
12" L x 18" W x 12" H



- RCPDCS5-GN GREEN
- RCPDCS5-BK BLACK
- RCPDCS5-BR BROWN
- RCPDCS5-BB BLACK W/ BROWN TRIM
- RCPDCS5-GB GREEN W/ BLACK TRIM

150 GALLON BULK DIVOT MIX SAND & SEED CONTAINER

26" L x 41" W x 33" H



- RCPDMB-LG-GN GREEN
- RCPDMB-LG-BK BLACK
- RCPDMB-LG-BR BROWN

ROUND DIVOT MIX CONTAINER

10 Gallon - 20" L x 20" W x 22" H



- RCPDMC-SR10-GN GREEN
- RCPDMC-SR10-BK BLACK
- RCPDMC-SR10-BR BROWN

DIVOT PRO JUNIOR

5 Gallon
29" L x 18" W x 35" H



- PAR3420 HUNTER GREEN
- PAR3421 BLACK
- PAR3422 REDWOOD
- PAR3423 CAMEL

DIVOT MATE WITH LOW STAND



SEED & SOIL BUTLER



QUAD SOIL CADDIE

Holds 4 Bottles



- PAR435-00 BLACK
- PAR435-02 HUNTER GREEN
- PAR3030 STAND ONLY

STD18970 GREEN

STD18890

ROUND DIVOT MIX CONTAINER

3.5 Gallon - 29" L x 18" W x 35" H
5 Gallon - 14" L x 14" W x 17" H



- RCPDCR3.5-GN 3.5 GAL - GREEN
- RCPDCR3.5-BK 3.5 GAL - BLACK
- RCPDCR3.5-BR 3.5 GAL - BROWN
- RCPDCR5-GN 5 GAL - GREEN
- RCPDCR5-BK 5 GAL - BLACK
- RCPDCR5-BR 5 GAL - BROWN

PLASTIC & ALUMINUM SCOOPS



- PAR400 8 OZ PLASTIC
- PAR456 16 OZ PLASTIC
- GCAAS12 12 OZ ALUMINUM
- DRESS SAND SCOOP

DIVOT BOTTLES



1 - BOTTOM-FILL CURVE NECK
CAPACITY 45 OZ.

DRESB100

2 - HANDLE GRIP BOTTLE
BOTTOM-FILL CURVED NECK
CAPACITY 45 OZ.

DRESB800

3 - TOP-FILL CURVE NECK
CAPACITY 35 OZ.

DRESB650 0

4 - TOP-FILL STRAIGHT NECK
CAPACITY 32 OZ.

DRESB150

5 - NEW RATTLE-PROOF CAP
BOTTOM-FILL CURVE/GRIP NECK -
CAPACITY 45 OZ.

DRESB750

6 - OVERSIZE BOTTLE
BOTTOM-FILL CURVED NECK
LARGE CAPACITY 78 OZ.

STD18802

REPLACEMENT CAPS

For Sand Bottles Above



FLAT STYLE

RATTLE PROOF

DRECAP555 BOTTOM FILL - FLAT CAP

DRECAP554 BOTTOM FILL - RATTLE PROOF CAP

KADDIE KLIP

Walking Divot Bottle



- Introducing Kaddie Klip - a lightweight solution that simply clips anywhere
- No assembly or mounting required
- Easily stores 16 ounces of anything you choose including 7 golf balls or sand/seed mix
- Each 13 inch Kaddie Klip is water-tight and constructed of durable plastic
- Made for walkers to carry sand while they golf



DRECC100

TEE SEED & SOIL CADDIE

With Holder



- Contoured bottle keeps mixture dry
- Steel powder-coated holder included
- Includes decal and 78 oz (2.3 L) bottle with screw-on cap
- Available in two colors – Hunter Green and Black

STD18800 BLACK

STD18900 GREEN

DIVOT BOTTLE FAIRWAY CADDIE

Laser Cut Metal



- Laser cut metal w/ spike easily goes into the ground
- For bottles order **DRESB750**

DRESBH-BK BLACK

DRESBH-GN GREEN

UNIVERSAL HOLDER KIT

Includes Mounting Bracket



DREHO500 HOLDER ONLY

DREHO501 HOLDER ONLY SLOTTED

SOLID COLOR FLAGS



- PW6X8PL PRACTICE GREEN
- PW14X20PL REGULATION
- PW18X25PL RANGE

CHECKERED FLAGS



- PW6X8CK PRACTICE GREEN
- PW14X20CK REGULATION
- PW18X25CK RANGE

DIAGONAL FLAGS

Minimum 9 Flags Per Order



- PW6X8DGPL PRACTICE GREEN
- PW14X20DGPL REGULATION



DIAGONAL NUMBERED FLAGS

Minimum 9 Flags Per Order



- PW14X20DNS REGULATION SINGLE NUMBER
- PW14X20DND REGULATION DOUBLE NUMBER

NUMBERED FLAGS

Minimum 9 Flags Per Order



- PW6X8N PRACTICE GREEN
- PW14X20N REGULATION
- PW18X25N RANGE

TUBE STYLES

Hard Tubes

- Flag sits on flagstick with a hard, plastic internal tube.

Soft Tubes

- Flag sits on flagstick with a soft, nylon inner tube and grommet on top.

Grommets

- Flag connects to flagstick using 3 grommets (no tube). Requires swivel adapter on flagstick.

DIRT GUARDS



- Keep your flags looking new
- Six colors available
- Polyethylene cover fits securely over tube for a long-lasting, clean look!

PWDG PLASTIC DIRT GUARD

BORDERS & FABRIC SLEEVES

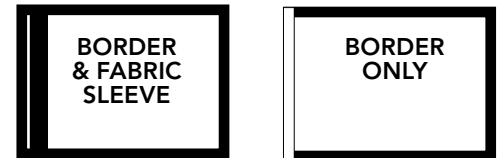

CUSTOM LOGO REGULATION GOLF FLAGS



SINGLE SIDED SCREEN PRINTED
Regulation

PW14X20SP

Up to 6 colors
Minimum 9 flags per order
Logo on front side only



DOUBLE SIDED SCREEN PRINTED
Regulation

PW14X20SPD

Up to 6 colors
Minimum 9 flags per order
Logo reads correct on both sides



EMBROIDERED LOGO FLAGS
Regulation

SINGLE SIDED PW14X20ESS

DOUBLE SIDED PW14X20EDS

Up to 6 colors
Minimum 9 flags per order
Single sided reads reverse on back
Double-sided reads correctly on both sides



- All flags made of 400 denier nylon for the highest quality and longest life. Call one of our experienced reps to further customize the shape, borders or mounting style of your flag.
- Our in house artists will help you create your design and convert your logo into a vector file for printing Art set-up fees may apply on new orders. Extra charge for screen print (waived with 27 or more flags) and extra charge for embroidered flag (waived with 36 or more flags)



CHECK SCREEN PRINTED FLAGS

Double Sided



PW14X20CKSP

Up to 6 colors
Minimum 9 flags per order
Logo reads correct on both sides

CHECKERED EMBROIDERED FLAGS



SINGLE SIDED PW14X20CKES

DOUBLE SIDED PW14X20CKEDS

Up to 6 colors
Minimum 9 flags per order
Single sided reads reverse on back
Double-sided reads correctly on both sides

DIAGONAL LOGO FLAGS

Single Or Double-Sided



SINGLE SIDED PW14X20DGE

DOUBLE SIDED PW14X20DGED

Up to 6 colors
Minimum 9 flags per order
Single sided reads reverse on back
Double-sided reads correctly on both sides
Available in embroidery or screen print

PRACTICE GREEN LOGO FLAGS

SCREEN PRINTED



SINGLE SIDED PW6X8SP-
DOUBLE SIDED PW6X8SPDS-

Up to 6 colors
 Minimum 9 flags per order
 Single sided reads reverse on back
 Double-sided reads correctly on both sides

EMBROIDERED



SINGLE SIDED PW6X8E
DOUBLE SIDED PW6X8EDS

Up to 6 colors
 Minimum 9 flags per order
 Single sided reads reverse on back
 Double-sided reads correctly on both sides

DIGITAL PRINTED LOGO



PW6X8DP

Minimum 9 flags per order
 Logo reads correct on both sides

DIGITAL LOGO FLAGS PHOTO QUALITY



Digital print flags are an excellent option for many uses

- Use for special tournaments with a custom logo
- Use for logos that are photo quality or have too much detail for screen printing
- Use if you want the logo to print out all the way to the edge of the flag - entire flag can be printed on

REGULATION FLAGS

PW14X20DPS SINGLE SIDED
PW14X20DPD DOUBLE SIDED

Minimum 9 flags per order

Digital logo flags can be printed on the entire flag from edge to edge.

EMBROIDERED U.S. PIN FLAGS



- Cut and stitched stars and stripes give a really high end look to this flag
- 14 in x 20 in regulation size
EMBROIDERED STARS & STRIPES

PW14X20USEMB REGULATION

DIGITAL PRINT U.S. PIN FLAGS



- Double sided digital printed american flag
- 14 in x 20 in regulation size

DIGITAL PRINT

PW6X8DPUS US PRACTICE GREEN
PW14X20DPUS US REGULATION
PW6X8DP-TRL THIN RED LINE-PG
PW14X20DP-TRL THIN RED LINE-RG
PW6X8DP-TBL THIN BLUE LINE-PG
PW14X20DP-TBL THIN BLUE LINE-RG

PIN PLACEMENT FLAGS

- Slide up or down to indicate hole position. And remind players to "Please Repair Ball Marks"
- Placement flags fit flagsticks up to 3/4" diameter.
- Rubber grommets included.
- Made with Dupont SolarMax Nylon
- Set of 9



1/2" FLAGSTICK NO MESSAGE	3/4" FLAGSTICK NO MESSAGE	1/2" FLAGSTICK WITH MESSAGE	3/4" FLAGSTICK WITH MESSAGE
------------------------------	------------------------------	--------------------------------	--------------------------------

RED	STD05345	STD05347	STD05335	STD05337
YELLOW	STD05365	STD05367	STD05355	STD05357
WHITE	STD05371	STD05372		

SPECIAL LENGTH FLAGSTICKS

5, 10, 12 Foot Tall

- Longer flagsticks used to improve visibility on holes with hills
- Choose 5 foot, 10 foot or 12 foot tall
- 2 piece for reduced shipping costs - easily glues together and holds tight
- Available in white, yellow or black/white stripe
- custom colors available - please call 714-893-1555



PART #	DESCRIPTION	DIAMETER
PWFSS-YW	5 FOOT POLE - YELLOW	1/2"
PWFSS-WH	5 FOOT POLE - WHITE	1/2"
PWFSS-RD	5 FOOT POLE - RED	1/2"
PWFSS-RB	5 FOOT POLE - ROYAL BLUE	1/2"
PWFSS-PK	5 FOOT POLE - PINK	1/2"
PWFSS-OR	5 FOOT POLE - ORANGE	1/2"
PWFSS-KG	5 FOOT POLE - KELLY GREEN	1/2"
PWFSS-BK	5 FOOT POLE - BLACK	1/2"
PWFSS-CUSTOM	5 FOOT POLE - CUSTOM COLOR	1/2"
PWFS10-WH	10 FOOT POLE - WHITE	1/2"
PWFS10-YW	10 FOOT POLE - YELLOW	1/2"
PWFSS10-BW	10 FOOT POLE BLACK/WHITE STRIPE	1/2"
PWFS12-WH	12 FOOT POLE - WHITE	1/2"
PWFS12-YW	12 FOOT POLE - YELLOW	1/2"
PWFSS12-BW	12 FOOT POLE BLACK/WHITE STRIPE	1/2"
PWFS10T-WH	10 FOOT TAPERED - WHITE	3/4"
PWFS10T-YW	10 FOOT TAPERED - YELLOW	3/4"
PWFSS10T-BW	10 FOOT TAPERED BLACK/WHITE STRIPE	3/4"
PWFS12T-WH	12 FOOT TAPERED - WHITE	3/4"
PWFS12T-YW	12 FOOT TAPERED - YELLOW	3/4"
PWFSS12T-BW	12 FOOT TAPERED BLACK/WHITE STRIPE	3/4"



PWFSW7.5

FLAGSTICK W/ FIBERGLASS FITTING \$109.75

PWFSW7.5-B

FLAGSTICK W/ BRASS FITTING \$139.75



**IPE HARDWOOD
REGULATION FLAGSTICKS**

When You Want to Add the Extra Touch

- Made of high quality ipe hard wood
- 1/2" Black fiberglass top and bottom
- Aluminum grooved ferrule



5', 10' OR 12' POLES WITH 6 PRISM REFLECTORS

- Long Smartsticks
- A discrete and effective solution for gauging distance using a rangefinder.
- Prism Inserts come in black, white, or yellow
- Ferrules: Aluminum smooth, grooved ferrules or stainless steel grooved
- All poles two piece for less shipping costs

PWFS10LL-YW	10 FOOT PRISM POLE, YELLOW	1/2"
PWFS10LL-WH	10 FOOT PRISM POLE, WHITE	1/2"
PWFS12LL-YW	12 FOOT PRISM POLE, YELLOW	1/2"
PWFS12LL-WH	12 FOOT PRISM POLE, WHITE	1/2"
PWFS10TLL-YW	10 FOOT TOURNAMENT PRISM POLE, YELLOW	3/4"
PWFS10TLL-WH	10 FOOT TOURNAMENT PRISM POLE, WHITE	3/4"
PWFS12TLL-YW	12 FOOT TOURNAMENT PRISM POLE, YELLOW	3/4"
PWFS12TLL-WH	12 FOOT TOURNAMENT PRISM POLE, WHITE	3/4"

Pricing is subject to change.

REGULATION FLAGSTICKS 7.5'

Par Aide

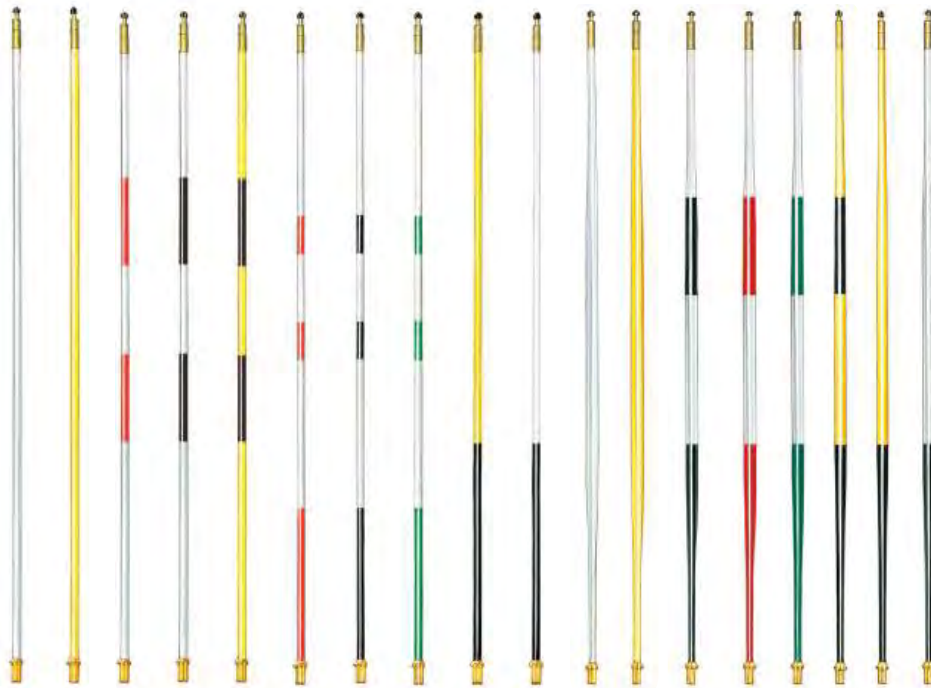

Par aide's exclusive patented ferrule design eliminates 66% of the friction and allows sand and soil to pass through, which eliminates sticking. The precise taper of the ferrule keeps the flagsticks standing straight with less wobble. Matched with a Par Aide cup, it's an unbeatable combination.

**Par Aide
FLAGSTICK PARTS**



PART #	DESCRIPTION
PAR1732-6	TOP STUD -PACK OF 6
PAR1729-6	FERRULE- PACK OF 6
PAR1733-6	ACORN NUT- PACK OF 6
PAR1740-10	QUICK RELEASE TOP STUD - PACK OF 10

PART #	STYLE - SOLD IN BOX OF 9
PAR740-0759	YELLOW 1/2"
PAR730-0759	WHITE 1/2"
PAR725-0759	2 STRIPE RED & WHITE 1/2"
PAR727-0759	2 STRIPE RED & WHITE 1/2"
PAR752-0759	2 STRIPE BLACK & WHITE 1/2"
PAR747-0759	2 STRIPE YELLOW & BLACK 1/2"
PAR720-0759	3 STRIPE RED & WHITE 1/2"
PAR750-0759	3 STRIPE BLACK & WHITE 1/2"
PAR755-0759	3 STRIPE GREEN & WHITE 1/2"
PAR745-0759	YELLOW WITH 30 IN. BLACK BOTTOM 1/2"
PAR754-0759	WHITE WITH 30 IN. BLACK BOTTOM 1/2"
PAR706-079	WHITE TOURNAMENT 3/4"
PAR707-079	YELLOW TOURNAMENT 3/4"
PAR708-079	BRITISH BLACK & WHITE STRIPE TOURNAMENT 3/4"
PAR712-079	BRITISH RED & WHITE STRIPE TOURNAMENT 3/4"
PAR713-079	BRITISH GREEN & WHITE STRIPE TOURNAMENT 3/4"
PAR714-079	BRITISH BLACK & YELLOW STRIPE TOURNAMENT 3/4"
PAR716-079	BRITISH BLUE & WHITE STRIPE TOURNAMENT 3/4"
PAR709-079	YELLOW WITH 30 IN. BLACK BOTTOM TOURNAMENT 3/4"
PAR711-079	WHITE WITH 30 IN. BLACK BOTTOM TOURNAMENT 3/4"

PINSITE REFLECTORS

Par Aide

- Nylon threaded PinSite Reflector – will not seize to top of flag stick
- Use with all laser golf distance measuring devices (including: Bushnell, Laser Link, Leupold, Nikon, Callaway, etc.)
- Premium glass prisms for maximum accuracy



PAR1736

1" ALUMINUM / FIBERGLASS FLAGSTICKS

Par Aide

A full 8 ft. (2.44 M) tall, this lightweight exclusive par aide design meets usga regulations. Top and bottom shanks are ½ in. (1.3 Cm) diameter, color-impregnated fiberglass in bright yellow, bright white, black and red for ultimate visibility. The powder-coated, 1 in. (2.5 Cm) diameter aluminum body allows for a completely custom look.

PART #	STYLE - SOLD IN BOX OF 9
PAR701-089	YELLOW 1/2"
PAR702-089	WHITE 1/2"
PAR703-089	WHITE W/ BLACK BOTTOM STRIPE
PAR704-089	WHITE W/ 2 BLACK STRIPES
PAR705-089	WHITE W/ 3 BLACK STRIPES

PRISM FLAGSTICKS

Par Aide

PART #	SOLD IN BOX OF 9 FLAGSTICKS
PAR740-0759-1	YELLOW 1/2"
PAR730-0759-1	WHITE 1/2"
PAR750-0759-1	3 STRIPE BLACK & WHITE 1/2"
PAR745-0759-1	YELLOW W/ 30" BLACK BOTTOM 1/2"
PAR706-079-1	TAPERED WHITE 3/4"
PAR707-079-1	TAPERED YELLOW 3/4"
PAR708-079-1	TAPERED BLACK & WHITE STRIPE 3/4"

VINYLSHIELD FLAGPOLE RESTORATION

VinylShield by Par West

An economical and easy way to re-new and protect splintered, cracked, faded, scratched, or dirty poles. Quickly applies with heat gun and will last for years. Fits tournament and regulation poles.

VSFS12-YW	YELLOW 250' ROLL FOR 1/2" POLE
VSFS12-WH	WHITE 250' ROLL FOR 1/2" POLE
VSFS34-YW	YELLOW 250' ROLL FOR 3/4" POLE
VSFS34-WH	WHITE 250' ROLL FOR 3/4" POLE

HIGH TEMPERATURE HEAT GUN

Use To Shrink VinylShield Tubing



- Economical, multi-purpose heat gun
- Heavy duty air blower provides rapid shrinking

VSVT-HG

SMARTY SIX

Screw-On Reflectors



- Screws on any flagstick to convert to laser link
- Reflectors are oriented to provide 360° reflectivity.
- Black Smarty 6 available with metal or nylon threads.

GCASM6-B BRASS THREAD

GCASM6-P PLASTIC THREAD

LASER REFLECTORS

Slide Over Reflectors - Set of 9



- Full 360° visibility, no dead spots, made of highly reflective material with a large surface area.
- Comes with Grommets to hold on flagstick
- Made for both 1/2" and 3/4" poles. Sold in sets of 9.

GCALR12 1/2" OPENING

GCALR34 3/4" OPENING

Pricing is subject to change.

All royaline flagsticks now contain a veil-wrap that is added during the manufacturing process. Standard Golf is the only flagstick manufacturer that uses a protrusion manufacturing method to apply the veil wrap.

- Royaline flagsticks have the perfect ferrule to lock into the smart fit cups
- Solution for pre-mature wear
- Notched-ferrule flagsticks fall into place every time
- Reinforced ribs allow dirt and sand to freely sift through cup to eliminate sticking



ROYALINE 3/4" TOURNAMENT FLAGSTICKS 7.5'
Standard Golf



PART #	DESCRIPTION
STD26300	WHITE
STD26301	WHITE/BLACK BRITISH STRIPE
STD26302	WHITE/RED BRITISH STRIPE
STD26303	WHITE/GREEN BRITISH STRIPE
STD26304	WHITE W/ 30" BLACK BOTTOM
STD26306	WHITE W/ 4 BLACK STRIPES
STD26310	YELLOW
STD26311	YELLOW/BLACK BRITISH STRIPE
STD26314	YELLOW W/ 30" BLACK BOTTOM
STD26315	NEW! WOOD GRAIN

LASER REFLECTOR

Flagstick Top Reflectors

- Easily replaces acorn nut on Standard, Par Aide, and all other flagsticks with 3/8-24 threaded tip.
- Features nylon threads. No more metal-on-metal seizing associated with brass inserts.
- New five-glass prism pod design maximizes reflectivity, leaving no dead spots.
- Prisms snap into place for extra durability.



STD26600

ROYALINE 1/2" REGULATION FLAGSTICKS 7.5'
Standard Golf

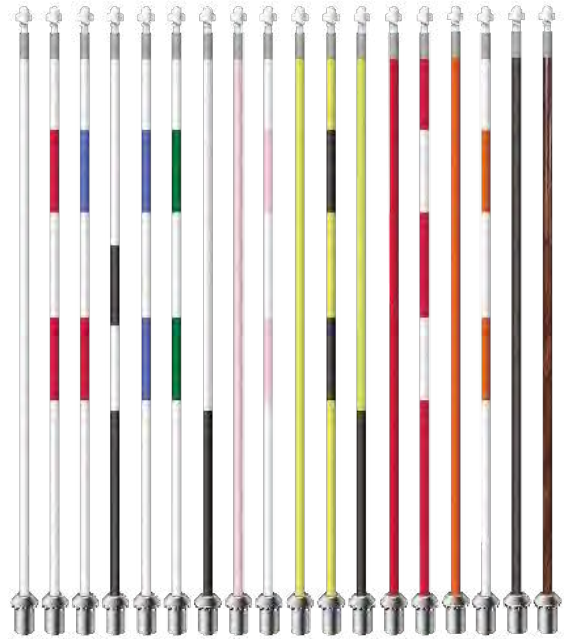

PART #	DESCRIPTION
STD26100	WHITE
STD26101	WHITE/RED STRIPE
STD26102	WHITE/BLUE/RED STRIPE
STD26103	WHITE/BLACK BRITISH STRIPE
STD26104	WHITE/BLUE STRIPE
STD26105	WHITE/GREEN STRIPE
STD26106	WHITE/30" BLACK BOTTOM
STD26107	PINK
STD26108	WHITE/PINK STRIPE
STD26110	YELLOW
STD26111	YELLOW/BLACK STRIPE
STD26112	YELLOW/30" BLACK BOTTOM
STD26114	ORANGE
STD26115	WHITE /ORANGE STRIPE
STD26120	RED
STD26121	RED/WHITE STRIPE
STD26130	BLACK
STD26134	NEW! WOOD GRAIN



STD26517 TRADITIONAL



STD26512 SMART FIT

FERRULES
Standard Golf



**RED / WHITE / BLUE
FLAGSTICKS**



Our 7.5' Flagstick with red, white and blue stripes to go with the american flag.

Flags sold separately

PWFSS7.5-RWB

U.S. PIN FLAGS



DIGITAL PRINT

PW6X8DPUS PRACTICE GREEN

PW14X20DPUS REGULATION

EMBROIDERED

PW14X20USEMB REGULATION

U.S. FLAG DECALS

Use With 935 Liners



NHUSFLG SET OF 36 DECALS

GREENS CADDIE FLAG SAVER STAND & SIGN

Keep Special Event Flags Off the Ground



- Our greens caddy keeps flags off of the ground
- 30 Inches tall
- Recycled lumber material never needs painting - no fading or chipping
- Available in black, green or white

GCAGC-GN GREEN

GCAGC-BK BLACK

GCAGC-WH WHITE

PWALS12X12-120S FLAG SIGN WITH POST

CUSTOM DECALS



- Add your course logo or celebrate events with a custom decal on your liner or cup
- Free art work

PAR520-1 (MINIMUM 36)

FLAGSTICK CADDIE

Hold Up To 18 Flagsticks

STD25000 1- FLAGSTICK CADDIE (2-PIECE) - HOLDS 18 FLAGSTICKS

STD25100 2- JR. FLAGSTICK CADDIE (2-PIECE) - HOLDS 6 FLAGSTICKS

STD25001 3- ALTERNATIVE BRACKET (2-PIECE)

STD25002 4- REPLACEMENT FLAGSTICK HOLDER



Pricing is subject to change.



EVER-WHITE CUPS



- The patented ever-white cup has revolutionized the putting cup by teaming an aluminum outside with a replaceable bright white plastic sleeve
- No paint to chip, no need to strip and re-powdercoat
- Cups can easily stay white all season long by replacing sleeves every time they get dirty
- Still get the classic sound of a ball dropping into an aluminum cup
- Replacement liners come in a box of 18
- Pink liners available for special tournaments
- Custom decals to add even more detail to your cups or even to sell advertising on for a fundraising tournament



- PAR935** EVER-WHITE CUP
- PAR935-1** LINERS (CASE OF 18)
- PAR935-4** PINK LINERS

6" ALUMINUM REGULATION CUPS



- Our classic & best selling model
- It's die cast oversize, then machined down to precision dimensions to minimize wobble in the hole
- Powder coated so no paint to chip
- Meets all USGA regulations also available in pink for special tournaments
- Pga tournament version also available - call for details

- PAR930** WHITE
- PAR930-99** PINK



6" ZINC REGULATION CUPS

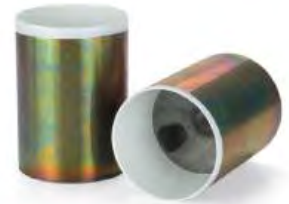

PAR937

6" PLASTIC REGULATION CUPS



PAR920



SMART-FIT CUPS
Standard Golf STD2000



- Notched-ferrule flagsticks fall right into place every time without twisting, sticking or sinking.
- Bonderite aluminum cups for maximum life and the most chip-resistant coating around.
- High strength plastic cups molded with chemical-resistant polymers provide a brilliant, lasting finish.
- Hybrid cup is an aluminum base cup with plastic over-molded sides.
- Meets all USGA regulations

- STD18333 ALUMINUM
- STD18222 PLASTIC
- STD18333P ALUMINUM - PINK
- STD18444 HYBRID



ALUMINUM



PLASTIC



HYBRID



4" & 6" PLASTIC REGULATION CUPS
Riji Cup



- STD18200 6" WHITE
- STD18100 4" WHITE



4" & 6" ALUMINUM REGULATION CUPS



- STD18303 6" WHITE
- STD18303P 6" PINK
- STD18150 4" WHITE

SPECIAL EVENT CUPS
6" Steel



- STD18600 WHITE
- STD18600P PINK

SPECIAL EVENT CUPS
8" Steel



- STD18700 WHITE
- STD18700P PINK



SPECIAL EVENT CUPS
8" Plastic



- STD18775 WHITE

SPECIALTY CUP HOLE CUTTERS

- STD28775 STANDARD 6" HOLE CUTTER
- STD28785 STANDARD 8" HOLE CUTTER



STANDARD GOLF CUP CADDIE
Utility Cart Rack For Golf Cups

STD18990

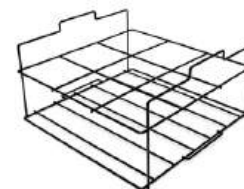

HIO XACT HOLE CUTTER



- Advanced ratcheting system for easy plug removal
- Three linear guide rails ensure accurate, smooth, and consistent operation
- Revolutionary three-way locking system
- Built-in bubble level
- Molded on grips
- Enhanced blade technology
- Depth gauge allow for uniform cup depth every time



- PAR1006-1 INSIDE STRAIGHT
- PAR1006-2 OUTSIDE STRAIGHT
- PAR1010-01 INSIDE SHARPENED REPLACEMENT BLADE
- PAR1010-02 OUTSIDE SHARPENED REPLACEMENT BLADE
- PAR1033-1 DEPTH GAUGE
- PAR1033-2 DOCKING STATION

DEPTH GAUGE

DOCKING STATION



SG PRO HOLE CUTTER

Included Depth Gauge Allows For Uniform Cup Depth Every Time



- Cut perfectly circular, crisp holes every time
- Safe for your body - lift and throw the hammer mechanism - saving stress on your back
- Ratchet ejection allows you to easily remove and place plugs as needed, in full
- Will easily cut through the hardest "push up" greens and perform equally as well in USGA greens
- Easy for all crew members to operate
- Included depth gauge allows for uniform cup depth every time.
- Bubble level embedded in handle
- To lubricate moving parts, use a good quality white lithium grease available from auto parts or farm stores



DOCKING STATION



- STD29000 INSIDE STRAIGHT
- STD29010 OUTSIDE STRAIGHT
- STD29001 INSIDE SHARPENED REPLACEMENT BLADE
- STD29002 OUTSIDE SHARPENED REPLACEMENT BLADE
- STD29003 SG DEPTH GAUGE
- STD29004 SG DOCKING STATION



SHOLE HOLE CUTTER SYSTEM

Includes Shoe, Cutting Board, & Depth Rings



- GCA1013KIT-COM** SHOLE HOLE CUTTER SYSTEM-COMPRESSION (SAND GREENS)
- GCA1013KIT-NON** SHOLE HOLE CUTTER SYSTEM-NON COMPRESSION (NATIVE GREENS)
- GCA1013BC** INSIDE SHARPENED REPLACEMENT BLADE
- GCA1013BN** OUTSIDE SHARPENED REPLACEMENT BLADE
- GCA1013HG** HOLE CUTTING GUIDE WITH DEPTH RINGS
- GCA1013-COM** SHOLE HOLE CUTTER ONLY-COMPRESSION (SAND GREENS)
- GCA1013-NON** SHOLE HOLE CUTTER ONLY-NON COMPRESSION (NATIVE GREENS)

HIO HOLE CUTTER

Par Aide



- Superintendents everywhere have been won over by it's precision, ease-of-use, time, and body-saving ability
- Simply pull out the pin, lift the handle, and the hammer action will pound the hole cutter into the ground



- PAR1003-1** INSIDE SHARPENED BLADE
- PAR1003-2** OUTSIDE SHARPENED BLADE
- PAR1009-01** REPLACEMENT INSIDE BLADE
- PAR1009-02** REPLACEMENT OUTSIDE BLADE

PAR AIDE HOLE CUTTERS



- 1. LEVER ACTION HOLE CUTTER**
- PAR1001-1** INSIDE SCALLOPED
 - PAR1001-2** OUTSIDE SCALLOPED
 - PAR1001-3** INSIDE STRAIGHT
 - PAR1001-4** OUTSIDE STRAIGHT
- LEVER ACTION WITH BUBBLE LEVEL**
- PAR1001-19** INSIDE SCALLOPED
 - PAR1001-29** OUTSIDE SCALLOPED
 - PAR1001-39** INSIDE STRAIGHT
 - PAR1001-49** OUTSIDE STRAIGHT
- 2. FOOT EXTRACTION HOLE CUTTER**
- PAR1002-1** INSIDE SCALLOPED
 - PAR1002-2** OUTSIDE SCALLOPED
 - PAR1002-3** INSIDE STRAIGHT
 - PAR1002-4** OUTSIDE STRAIGHT

STANDARD GOLF HOLE CUTTERS



- 1. MAGNUM LEVER ACTION HOLE CUTTER**
- STD28960** INSIDE STRAIGHT SHELL
 - STD28970** INSIDE SCALLOPED SHELL
 - STD28980** OUTSIDE SCALLOPED SHELL
- 2. PRO II REGULATION FOOT EXTRACTION HOLE CUTTER**
- STD28700** INSIDE STRAIGHT
 - STD28800** INSIDE SCALLOPED
 - STD28801** OUTSIDE SCALLOPED
 - STD28775** PRO II 6" HOLE CUTTER
 - STD28785** PRO II 8" HOLE CUTTER

REPLACEMENT BLADES

Par Aide



- PAR1007-01 INSIDE STRAIGHT
- PAR1007-02 OUTSIDE STRAIGHT
- PAR1008-01 INSIDE SCALLOPED
- PAR1008-02 OUTSIDE SCALLOPED

REPLACEMENT BLADES

Standard Golf

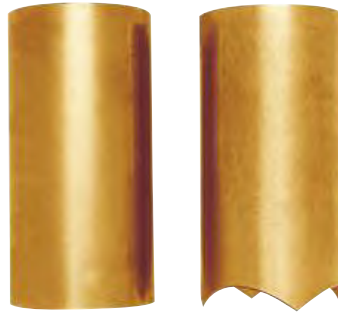

- STD28927 INSIDE STRAIGHT
- STD28952 INSIDE SCALLOPED
- STD28953 OUTSIDE SCALLOPED
- STD28777 6" PRO II SHELL
- STD28787 8" PRO II SHELL

BLADE SHARPENER



STD28400

NEW PRODUCT!

PINPOINT CUP CHANGER



- Increased leverage improves efficiency.
- Easily remove and place cups without bending over, saving your lower back
- Set cups without damaging cup edges or leaving indents on the turf
- Adjust ferrule height for perfect cup depth
- To lubricate moving parts, use a good quality white lithium grease available from auto parts or farm stores

STD33300

PAR AIDE CUP PULL

- Features long rod and rubber handle for maximum leverage and comfort. Plated steel construction. Three-hook design pulls cup out of hole straight and with ease, with no damage to the turf.



PAR1032 INSIDE STRAIGHT

115 VOLT ELECTRIC CUP CUTTER SHARPENER



SHPECS3.5



TURNING BOARDS

- Made to prevent damage to collars or clean-up passes while turning walk mowers
- Made of lightweight HDPE material for easy transportation and long life span
- Comes in two size
24" x 48"
24" x 96"

GCATB24X48 24" X 48"

GCATB24X96 24" X 96"



PW HOLE CUTTER GUIDE



NEW PRODUCT!

PWPCHCG

HOLE CUTTER GUIDE



PAR1030

CUP SETTER



PAR1031 ALUMINUM
STD30100 PLASTIC

DEPTH GAUGE



PAR1034 PAR AIDE
STD28600 STANDARD GOLF

Use Our Perma-Core Color Option Key To Choose Your Color!

CUP HOLE TRIMMING SCISSORS



PAR1036

CUP HOOK

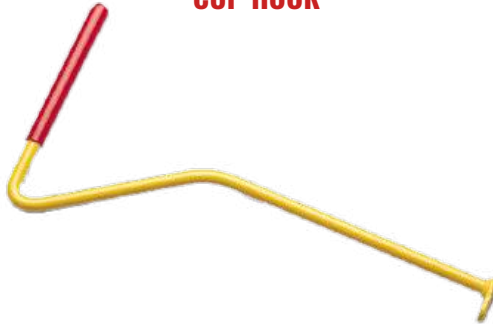

STD33200

GREEN KEEPERS BUCKET



GCA0937

CREW CADDY



PAR1038

HOLE CUTTER CARRIER



PAR1011

CLEAN CUT CUP AUGER



PAR655661

CUP HOLE CLEANER



PAR950

DELUXE METAL CUP SETTER



NEW PRODUCT!

STD30200

HOLE GROOMER

- Refresh your practice green holes daily
- Quick and simply place into existing hole and pull the lever
- Hole is firmed and cleaned to exact proper size with crisp edges

GCA0922

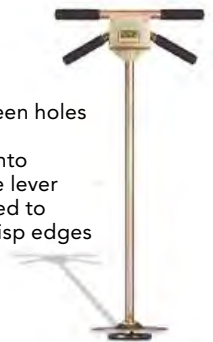

HOLE IN WHITE PAINT



- Our best selling brand for years
- More visible target that can speed up play
- Improve/upgrade course standards to tournament levels
- Plastic shield used to protect cups from overspray
- Sold in cases of 12 cans
- Also available in pink for special tournaments. **Pink paint sold in cases of 6 only.**

- GCAHIWD** DEVICE
- GCAHIWP** CASE OF PAINT
- GCAHIWP-D** PLASTIC SHIELD
- GCAHIWPPK** PINK PAINT

360 HOLE PAINT



- Paints the top 1" above the cup white using a unique nozzle that sprays 360 degrees all at once.
- Simply push down on the paint can 2-4 times to whiten
- Cup shield rests on top of the cup to protect against over-spray and dripping.
- No rotating of the can is necessary
- Sold in case of 12 cans

- PAR911** DEVICE
- PAR910** CASE OF PAINT
- PAR911-2** PLASTIC SHIELD (10 PACK)

E-ZEE WHITE HOLE WHITENER



- Clean, crisp white holes made quick and easy.
- Simply insert paint can into tool and rotate.
- Specially formulated to maximize whiteness on dirt.
- Built-in shield protects cup and green from overspray
- One-piece patented design; no assembly required.

- STD55600** DEVICE
- STD55700** CASE OF PAINT

PAINT SOLD IN CASES OF 6 CANS

PAR AIDE CUP SAVER



- Protects cups while spraying Greens, topdressing, or painting edges
- Made of durable plastic
- Cone shaped with easy grab stem
- Set of 5 cup savers

PAR1073

TARGET RINGS



- Used in place of paint to whiten the top edge of the cup
- Plastic ring protects the edge of the cup
- Great for practice Greens where cups aren't changed daily
- Sold in case of 18 rings

GCAGHT WHITE RINGS

TARGET RING & CUP SETTER



- Made specifically for use with hole targets
- Use as cup setter as well
- Made of cast aluminum

PAR655626

PAR AIDE AERIFYING CUP PLUGS



SET OF 9

- Made from durable, lightweight, weather-resistant foam material
- Used when aerating greens to protect integrity of the hole
- Used when topdressing greens to keep sand from filling up cup hole
- Can be left in holes during winter months
- Aeration tines able to penetrate plug without pulling it out of the hole

- PAR1070** REGULATION CUP SIZE
- PAR1071** PRACTICE CUP SIZE

PLASTIC CUP COVER



- 4 1/4" in diameter
- Economical cover "fills" top of the hole
- Sits on top of a recessed cup flush with the surface of the green
- Made from a synthetic polymer for a lighter and more durable construction
- Will not damage mower blades

STD18510

STEEL CUP COVER



- 4 1/4" in diameter
- Lid will sit flush to green when installed properly
- 4 1/4" (10.8 cm) cover is powder-coated steel.
- 6 (15.2 cm) and 8 (20.3 cm) covers are powdercoated aluminum.

- STD18500** 4 1/4" DIAMETER
- STD18650** 6" DIAMETER
- STD18750** 8" DIAMETER

REPLACEMENT PARTS
Par Aide Hio Hole Cutter



RUBBER GRIP
PAR1003-9 (PAIR)

TWO-PIECE STEEL HANDLE
PAR1003-21

LOCKING PIN, SPRING & BALL KIT
PAR1003-22

OUTER TUBE
PAR1003-7

EJECTING HANDLE
PAR1003-8

ROPE
PAR1003-17

RUBBER RING
PAR1003-13

DEPTH GAUGE
PAR1034

HiO BUBBLE LEVEL
PAR1028



EJECTING ROD
PAR1003-10

CLEAT
PAR1003-16



Outside sharpened
blade for push up,
native soil greens



Inside sharpened
blade for sand
based greens

REPLACEMENT BLADE, INSIDE SHARPENED
PAR1009-01

REPLACEMENT BLADE, OUTSIDE SHARPENED
PAR1009-02

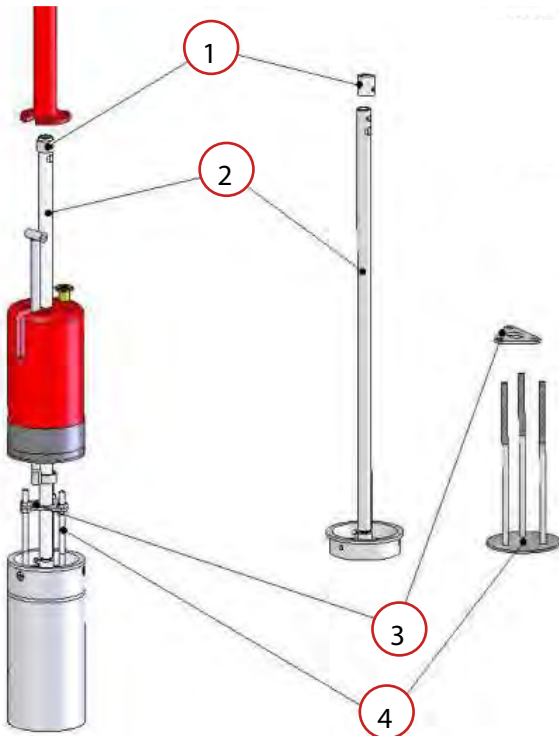

INNER TUBE
PAR1003-25



INTERNAL PARTS DIAGRAM

TRIANGLE PLATE
PAR1003-26



PISTON
PAR1017



STOP RING & PIN KIT
PAR1003-23



REPLACEMENT PARTS

Par Aide Lever Action Hole Cutter

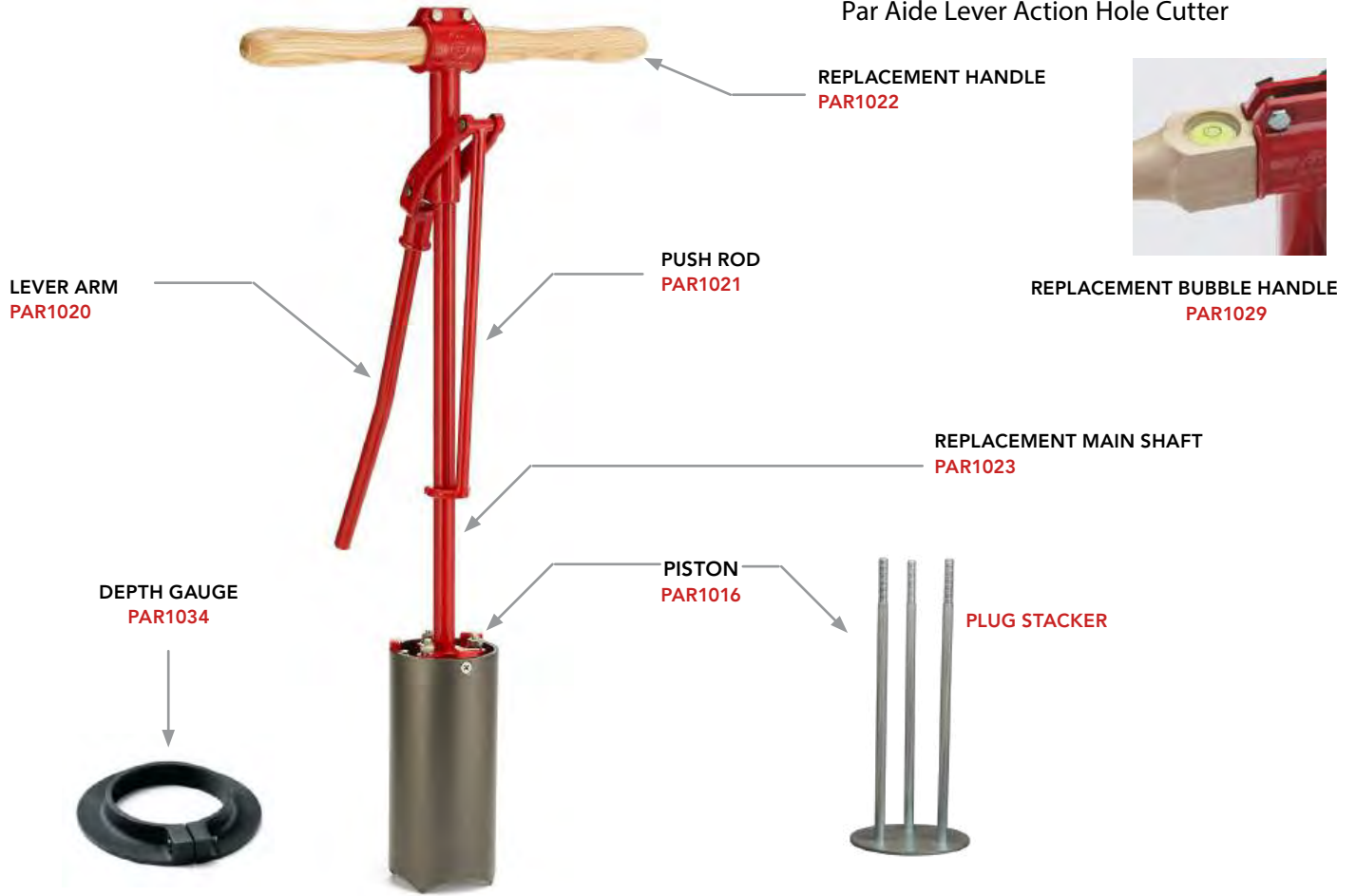

Foot Extraction Hole Cutter

Same parts as lever action above except for main shaft assembly

MAIN SHAFT ASSEMBLY PAR1024



REPLACEMENT BLADE, INSIDE SCALLOPED PAR1008-01

REPLACEMENT BLADE, OUTSIDE SCALLOPED PAR1008-02

REPLACEMENT BLADE, INSIDE STRAIGHT PAR1007-01

REPLACEMENT BLADE, OUTSIDE STRAIGHT PAR1007-02

GREENS BULLET



- Use in conjunction with quick-fill for amazing results
- See our video online
- Lightweight and durable stainless steel
- Adjustable depth collar

PAR550655

STEP 1



STEP 2



STEP 3



QUICK-FILL BALL MARK ERASER

- Improves the appearance of Greens damaged from ball marks
- Tube drops the perfect amount of sand into the ball mark every time
- No bending over or getting on your knees with a "ketchup" bottle

PAR550650



ACCUFIX

Ball Mark Repair Tool



PAR1092

BALLMARK TOOL

PAR1092-99

REPAIR KIT

ACCUFORM ACCUSEED



PAR13270

PLUG STACKER

1.5 dia., 2 dia., and 3 dia.



1.5" INCH

2" INCH

3" INCH

PAR500101 1.5"

PAR500102 2"

PAR500103 3"

GREENSKEEPER

Ball Mark Repair Tool



STD27200

GREENSKEEPER REPAIR KIT

All of the parts you need to repair your Greenskeeper

- 1-STD27202- Floor Plate
- 1-STD27203- Spring
- 1-STD27204-Spring Seat
- 4-STD27205- Fingers
- 4-STD27206- Roll Pin
- 2-STD27207-Snap Ring

STD27200R- COMPLETE KIT



THE FAIRWAY SNAKE

The Fairway Snake is a tool engineered specifically for the quick and easy removal of dew from fairways. The result is a patent-protected fairway dragging tool that cleans an entire fairway in a single pass. The Fairway Snake was developed to be gentle on turf as it rolls across the fairway, but also to be durable to withstand routine trips around the golf course. The Fairway Snake is the ideal tool for removing dew, grass clippings and earthworm castings from your fairways.

- Hugs the Fairway
- Weighted Core
- Extremely Flexible
- Strong, Durable and Reliable
- UV and Water Resistant
- Rolls or Spins Over the Turf

- TLTFS100 100' ROPE
- TLTFS150 150' ROPE
- TLTFS200 200' ROPE



DU-WHIPPER

- Sweep away morning dew or worm castings
- Telescoping pole stretches from 6' to 16'
- Easy to handle

STD34300



E-Z WHIP WHIPPING POLE
Slides In and Out of Handle



- PAR1060 WHIPPING POLE
- PAR1065 REPLACEMENT TIP
- PAR1066 REPLACEMENT HANDLE



GREENS SPEED METER

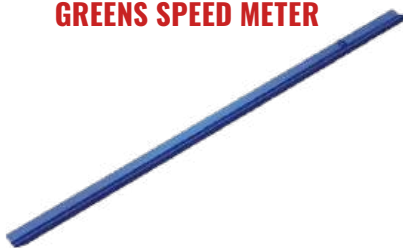

ACUGS101

BREAKMASTER GREEN SLOPE METER



- TLTBM BREAKMASTER
- TLTBMP BREAKMASTER PLUS

- Check slope of green before setting the cup
- Used by PGA, LPGA and Champions Tour Pros to read greens before Tournaments

PRISM GAUGE



ACUPG01

S550 PROFESSIONAL ROLLER SQUEEGEE

Professional Grade

- Removes water from greens and turf
- Non-absorbant roller
- 60" Ergonomic powder-coated aluminum



STD71324 24 INCH ROLLER SQUEEGEE

STD71336 36 INCH ROLLER SQUEEGEE

STD71348 48 INCH ROLLER SQUEEGEE

ACCUFORM ROLLER SQUEEGEE

Par Aide Products



- Removes water from greens and turf
- Non-absorbant roller features a heavy duty ribbed frame
- 60" bent, aluminum handle

PAR13220 24 INCH ROLLER SQUEEGEE

PAR13224 36 INCH ROLLER SQUEEGEE

TACIT DEW BRUSH



- Comes with an 8 foot wide brush head and 72 inch handle with internal dew whip
- Tacit produces two Dew Brushes for the discerning greenkeeper.
- Made with soft bristles that glides easily over the green clearing dew with a squeegee action
- Stiff bristles flicks the dew into larger droplets forcing them to be absorbed by the soil
- Both are light and easy to carry and both use Tacit's Switch as their handle

GCA1035 GREEN

SOD KNIFE

TLTSK3
HEAVY DUTY STAINLESS
STEEL

TLTSKB2 BLUE HANDLE,
SERRATED BLADE

TLTCK
COTTON KNIFE

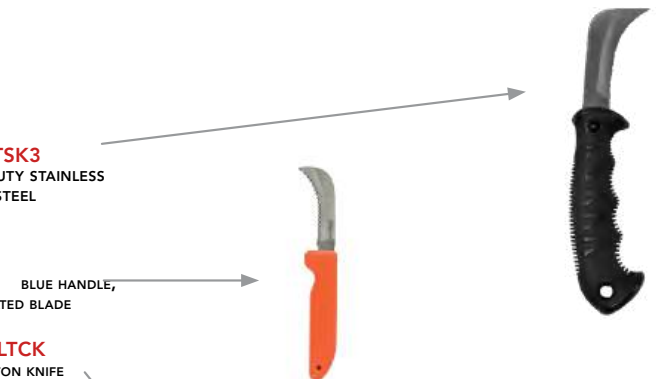

COTTON

ICE PICK



TLTIP

Accuform Ace II



PAR AIDE BUNKER RAKE HEADS

PART #	WIDTH	TYPE
PAR990-01	17"	ACCUFORM ACE II
PAR995-01	25"	ACCUFORM ACE II
PAR997-01	15"	ACCUCURVE



Accucurve

ALL HEADS LISTED ARE COMPATIBLE WITH ALL HANDLES BELOW

BUNKER RAKE HANDLES

All handles here are compatible with the heads above. Don't be fooled into the the knock-off handles out there that don't have the quality and dependability you get from these.

PART #	LENGTH	DESCRIPTION
PAR972-8	54"	PROTECT- GREEN
PAR972-9	72"	PROTECT- GREEN
PAR972-1	54"	HONEYCOMB- GREEN
PAR972	54"	GREEN ALUMINUM
PAR972-10	54"	BROWN ALUMINUM
PAR972-7	96"	GREY ALUMINUM

Fiberglass Protect Handle



Fiberglass Honeycomb Handle



Aluminum Green Handle



Aluminum Brown Handle



RAKE HANDLE GRIPS

Pack Of 10



RAKE HANDLE DECALS

Set Of 13

- PAR965-1 LEAVE RAKES IN BUNKERS DECAL
- PAR965-2 LEAVE RAKES OUT BUNKERS DECAL



PAR974-10



ACCUFORM ACE II RAKES KITS

Our Best Selling Rakes

17" HEADS - BOXES OF 25 - BEST VALUE

- PAR990-125 17 IN. ACE II 54 IN. HUNTER GREEN HONEYCOMB HANDLE
- PAR990-525 17 IN. ACE II 54 IN. HUNTER GREEN ALUMINUM HANDLE
- PAR990-825 17 IN. ACE II 54 IN. HUNTER GREEN PROTECT HANDLE
- PAR990-1025 17 IN. ACE II 54 IN. SIENNA BROWN ALUMINUM HANDLE
- PAR990-925 17 IN. ACE II 72 IN. HUNTER GREEN PROTECT HANDLE

25" HEADS - BOXES OF 25 - BEST VALUE

- PAR995-125 25 IN. ACE II 54 IN. HUNTER GREEN HONEYCOMB HANDLE
- PAR995-525 25 IN. ACE II 54 IN. HUNTER GREEN ALUMINUM HANDLE
- PAR995-825 25 IN. ACE II 54 IN. HUNTER GREEN PROTECT HANDLE
- PAR995-1025 25 IN. ACE II 54 IN. SIENNA BROWN ALUMINUM HANDLE
- PAR995-925 25 IN. ACE II 72 IN. HUNTER GREEN PROTECT HANDLE



ACCUCURVE RAKE KITS

15" Head - Box of 25

Its design combines the profile of our Bunker Pro rake with the lightweight feel of the Accuform Ace II.

- PAR997-125 54 IN. HUNTER GREEN HONEYCOMB HANDLE
- PAR997-525 54 IN. HUNTER GREEN ALUMINUM HANDLE
- PAR997-825 54 IN. HUNTER GREEN PROTECT HANDLE
- PAR997-1025 54 IN. SIENNA BROWN ALUMINUM HANDLE
- PAR997-925 72 IN. HUNTER GREEN PROTECT HANDLE

102 BUNKER MAINTENANCE

STANDARD GOLF BUNKER RAKE HEADS



PART #	WIDTH	TYPE
STD11901	20"	THE CHIEF
STD11701	20"	TOUR PRO
STD11771	25"	TOUR PRO
STD11801	15"	TOUR SMOOTH II
STD12202	22"	TOUR SMOOTH II
STD12301	15"	TOUR-LITE
STD11601	15"	ECONOMY
STD11501	15"	DUO-RAKE

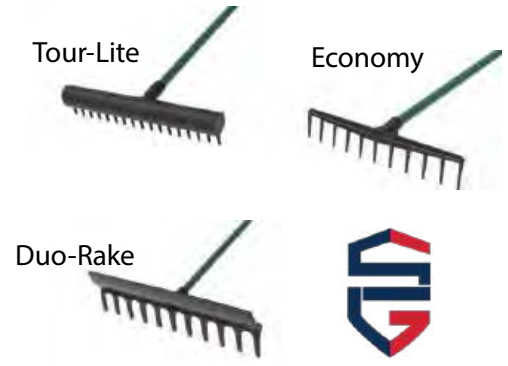

"THE CHIEF" RAKE KITS

20" Head for Aussie Style Raking



- STD11900 54 IN. GREEN ALUMINUM HANDLE - CASE OF 12
- STD11910 60 IN. GREEN GATOR GRIP HANDLE - CASE OF 12
- STD11920 72 IN. GREEN GATOR GRIP HANDLE - CASE OF 6

TOUR PRO RAKE KITS

20" Or 25" Head



- 20" HEADS
- STD11760 54 IN. GREEN ALUMINUM HANDLE (CASE OF 12)
 - STD11700 54 IN. GREEN COMPOSITE HANDLE (CASE OF 12)
 - STD11720 60 IN. GREEN GATOR GRIP HANDLE (CASE OF 12)
 - STD11730 60 IN. BROWN GATOR GRIP HANDLE (CASE OF 12)
- 25" HEAD
- STD11790 60 IN. GREEN GATOR GRIP HANDLE (CASE OF 6)
 - STD11770 72 IN. GREEN GATOR GRIP HANDLE (CASE OF 6)
 - STD11780 72 IN. BROWN GATOR GRIP HANDLE (CASE OF 6)

TOUR-LITE RAKE KIT

15" Head Option



- STD12375 54 IN. GREEN ULTRA LIGHT STEEL - CASE OF 12
- STD12350 54 IN. YELLOW ULTRA LIGHT STEEL - CASE OF 12

TOUR SMOOTH II RAKE KITS

15" & 22" Head Options



CART RAKE KIT

15" Head Option



- STD11400 48 IN YELLOW WOOD HANDLE, CASE OF 12
- STD11425 48 IN GREEN WOOD HANDLE, CASE OF 12
- STD11800 54 IN. GREEN COMPOSITE HANDLE - CASE OF 12
- STD11820 60 IN. GREEN GATOR GRIP HANDLE - CASE OF 12
- STD11830 60 IN. BROWN GATOR GRIP HANDLE - CASE OF 12
- STD11860 54 IN. GREEN ALUMINUM HANDLE - CASE OF 12
- STD12210 60 IN. GREEN GATOR GRIP HANDLE - CASE OF 6

Pricing is subject to change.



DUO-RAKE KIT 15" Head Option



- STD11575 54 IN. GREEN ALUMINUM - CASE OF 12
- STD11525 54 IN. YELLOW ALUMINUM - CASE OF 12
- STD11500 54 IN. NATURAL ALUMINUM - CASE OF 12
- STD11540 64 IN GREEN CURVED HANDLE, CASE OF 6
- STD11530 64 IN GOLD CURVED HANDLE, CASE OF 6
- STD11545 72 IN GREEN COMPOSITE HANDLE, CASE OF 12

ECONOMY RAKE KIT 15" Head Option

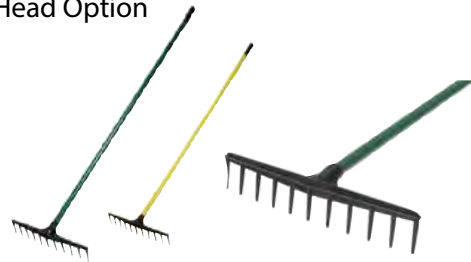

- STD11665 54 IN. GREEN ULTRA LIGHT STEEL - CASE OF 12
- STD12350 54 IN. YELLOW ULTRA LIGHT STEEL - CASE OF 12
- STD11625 48 IN GREEN WOOD HANDLE

BUNKER RAKE HANDLES

PART #	LENGTH	DESCRIPTION
STD11200	60"	GREEN GATORGRIP
STD11210	72"	GREEN GATORGRIP
STD11201	60"	BROWN GATORGRIP
STD11211	72"	BROWN GATORGRIP
STD11710	54'	GREEN COMPOSITE
STD11516	54'	GREEN ALUMINUM
STD11205	54'	NATURAL ALUMINUM
STD11515	54'	YELLOW ALUMINUM
STD11532	64'	GOLD ALUMINUM



RAKE HANDLE CAPS

- STD11206 7/8" RAKE HANDLE CAP
- STD11207 15/16" RAKE HANDLE CAP



RAKE HANDLE DECALS

Set Of 13

- PAR965-1 LEAVE RAKES IN BUNKERS DECAL
- PAR965-2 LEAVE RAKES OUT BUNKERS DECAL



VINYLSHIELD FOR RAKE HANDLES

Easiest Way to Re-new Your Rakes



No more fiberglass splinters from your rake handles. An economical and easy way to re-new your rakes and protect splintered, cracked, faded, scratched, dirty fiberglass handles. Quickly applies with heat gun and will last for years. *Heat sensitive material, exposure to temperatures over 90F (32C) may cause premature shrinkage.*

- VSRH-125-BK BLACK 125' ROLL
- VSRH-250-BK BLACK 250' ROLL
- VSRH-125-GN GREEN 125' ROLL
- VSRH-250-GN GREEN 250' ROLL
- VSRH-125-YW YELLOW 125' ROLL
- VSRH-250-YW YELLOW 250' ROLL



BEFORE AFTER

125' feet does about 25 handles. 250 does about 50 handles

HIGH TEMPERATURE HEAT GUN

Use To Shrink VinylShield Tubing



- Economical, multi-purpose heat gun
- Heavy duty air blower provides rapid shrinking

VSVT-HG

104 BUNKER MAINTENANCE



DUAL HEAD RAKE



- PWDHR54** 54" GREEN PROTECT HANDLE
- PWDHR72** 72" GREEN PROTECT HANDLE
- CORRK24003-8** SPRING BACK RAKE HEAD ONLY

- Makes raking bunkers, pine straw or debris go much faster
- 48" wide head features 2 spring tine rake heads at exactly the right angle
- Available with a 54" or 72" lightweight handle, this rake meets all of your maintenance needs

WOOD TOOTH MAINTENANCE RAKE



- GCAWR35000** 28" HEAD W/ ANGLED HANDLE
- GCAWR35001** 28" HEAD W/ 90 DEGREE HANDLE
- GCAWRBT** CASE OF 100 WOODEN REPLACEMENT TEETH

- Available in junco angles head or 90 degree head
- 28 Inches wide x 2 inches tall x 2 inches thick
- 4 inch wood tines are replaceable
- Wood tines are 1 inch on center
- 60 Inch wood handle

BUNKER DEBRIS SIEVE

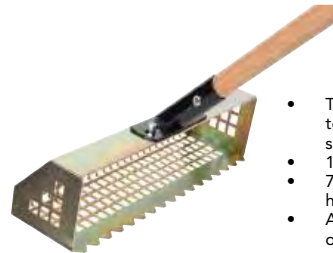

- The easy way to sift sand and to remove bunker debris and stones.
- 19" (48 cm) head
- 72" (183 cm) - 2 piece wood handle
- Available with 1/2" (1.3 cm) openings or 1/4" (.64 cm) openings

- STD29335** 19" HEAD W/ 72" WOOD HANDLE (1/2" OPENINGS)
- STD29330** 19" HEAD W/ 72" WOOD HANDLE (1/4" OPENINGS)

MECHANICAL RAKE ATTACHMENTS

SPRING TINE RAKE HEADS

Replacement Rake Head Only - No Frame



Replacement spring back rake heads are 24" wide each. The bolt through head mounts easily onto your existing set-up.

FRAME NOT INCLUDED

CORRK24003-8- RAKE HEAD ONLY

CULTI-TINES

For Loosening Sand



The culti-tine helps loosen compact bunker sand while avoiding pulling up barrier fabrics, stones and any subsurface materials.

ACUSLT-20 BAG OF 20

NO SNAG RAKE PRONG



The no snag rake prong digs into t sand to loosen it without catching li or rocks.

CTI4-175A

SIFTING SHOVEL



TLT49502

Pricing is subject to change.

SEYMOUR SPADE SHOVEL

Made to Edge Bunkers



We searched all over for the perfect shovel to edge bunkers and we found the Seymour Spade Shovel with a straight blade to cut the perfect edge.

- 14 Gauge
- 7 Inch x 12 inch straight blade
- Rear rolled step
- Fiberglass insert & permagrip™
- Industrial grade fiberglass handle comes in two sizes

SEY49454 30" D GRIP HANDLE

SEY49453 48" STRAIGHT HANDLE

ACCUFORM DEEP FACE RAKE



PAR995-7

8' ALUMINUM HANDLE W/ 25" ACCUFORM HEAD

MAINTENANCE RAKE



- Comes with a 60" padded fiberglass handle
- Great for removing debris without bringing sand out at the same time
- Fluffs bunker sand without moving it

STD11300 21" WIDE HEAD

ACCUSMOOVE MAINTENANCE BUNKER RAKE



- 22" wide maintenance bunker rake head
- Comes in 66" or 82" in orange powder coated aluminum handles

PAR13130 22" WIDE HEAD W/ 66" ORANGE POWDER COATED ALUMINUM HANDLE

PAR13134 22" WIDE HEAD W/ 82" ORANGE POWDER COATED ALUMINUM HANDLE

ACCUFORM LANDSCAPE RAKE



- Long rounded teeth for smooth, non-gouging raking action and a large striking edge excellent for grading.
- Comes in 24", 36" or 48" rake head widths.
- Comes in 66" orange powder coated aluminum handle

PAR13110 24" WIDE HEAD W/ 66" ORANGE POWDER COATED ALUMINUM HANDLE

PAR13114 36" WIDE HEAD W/ 66" ORANGE POWDER COATED ALUMINUM HANDLE

PAR13118 48" WIDE HEAD W/ 66" ORANGE POWDER COATED ALUMINUM HANDLE

ACCUFORM SCREENING RAKE



- Designed for sifting, grading and screening stones and debris from sand or fine soil.
- Comes in 24" or 36" rake head widths.
- Comes in 66" orange powder coated aluminum handle

PAR13120 24" WIDE HEAD W/ 66" ORANGE POWDER COATED ALUMINUM HANDLE

PAR13124 36" WIDE HEAD W/ 66" ORANGE POWDER COATED ALUMINUM HANDLE

106 COURSE & YARDAGE MARKINGS

900 FEET
600 FEET
300 FEET



Rust-oleum

Seymour

RUST-OLEUM PRECISION TURF MARKING PAINT

The Best Quality Marking Paint for Golf

- STD55001 WHITE
- STD55002 YELLOW
- STD55003 RED
- STD55004 ORANGE
- STD55005 GREEN
- STD55006 BLUE
- STD55007 FLORESCENT PINK
- STD55008 FLORESCENT ORANGE
- STD55009 FLORESCENT GREEN

- All paint sold in cases of 12 cans
- other colors available
- Marks up to 250% more linear feet than other brands; precision tip with virtually no overspray
- Resists early fading and chalking
- Dries in under 5 minutes



FREE FREIGHT ON 31 OR MORE CASES

DURA-STRIPE MARKING PAINT

- Bright, durable, and will not hurt and will not kill the grass.
- We offer all the colors needed to paint golf course marking including lateral and water hazards.
- Easy to use and easy to dispose of.
- Bright colors for high visibility.
- Durable so the course marking can be done less frequently.
- Golf course marking paints are formulated to be environmentally friendly, high in solids, low odor, durable, and with superior coverage.



- DSWH WHITE
- DSYW HIGH VISIBILITY YELLOW
- DSRB CAUTION BLUE
- DSGR SAFETY GREEN
- DSRED SAFETY RED

RUST-OLEUM PRECISION LINE INVERTED MARKING CHALK

Sold In Cases Of 12



- STD55301 WHITE
- STD55302 GREEN

ATHLETIC TURF STRIPING PAINT

Case Of 12 Cans



- RUS206043 WHITE
- RUS206045 YELLOW
- RUS206044 ORANGE

FREE FREIGHT ON 31 OR MORE CASES

HARD SURFACE STRIPING PAINT

For Concrete Or Asphalt



- STD55204 WHITE
- STD55205 YELLOW
- STD55202 LIGHT BLUE
- STD55203 RED
- STD55201 BLACK

FREE FREIGHT ON 24 OR MORE CASES

- Creates bright, sharp, well-defined lines; resists smudging
- For indoor/outdoor use on concrete, gravel or other types of pavement
- Dries in less than 10 minutes
- Sold in cases of 6 cans

Pricing is subject to change.

DOUBLE BARREL PAINT GUN



PAR12403

PAINT MARKING GUN



STD55000

STRIPING MACHINE



- STD55100 ATHLETIC FIELD
- STD55200 HARD SURFACE

HAZARD MARKER TOPS

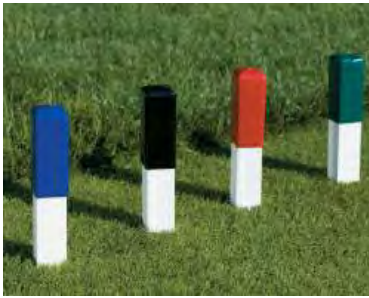

- Molded plastic caps fit on top of any of our recycled lumber stakes
- Use to mark special areas like environmentally sensitive areas or cart entrance / exits
- 1.5" x 1.5" x 4" long
- Sold in packs of 25

PWVC-WH	WHITE
PWVC-RD	RED
PWVC-GN	GREEN
PWVC-BK	BLACK
PWVC-RB	BLUE
PWVC-YW	YELLOW

RECYCLED HAZARD STAKES

With Spike & Beveled Top

- Recycled lumber plastic stake with traditional top
- 6" stainless spike
- UV resistant colors won't fade
- 1 1/2" square lumber



12" HAZARD STAKES

PWRPS-200-12	WHITE
PWRPS-300-12	YELLOW
PWRPS-100-12	RED
PWRPS-500-12	BLUE

18" HAZARD STAKES

PWRPS-200-18	WHITE
PWRPS-300-18	YELLOW
PWRPS-100-18	RED
PWRPS-500-18	BLUE

24" HAZARD STAKES

PWRPS-200-24	WHITE
PWRPS-300-24	YELLOW
PWRPS-100-24	RED
PWRPS-500-24	BLUE

36" HAZARD STAKES

PWRPS-200-36	WHITE
PWRPS-300-36	YELLOW
PWRPS-100-36	RED
PWRPS-500-36	BLUE

Custom sizes available up to 48"
All stakes made in-house.

FORCE FLEX MARKERS

Mow Over in Any Direction



- 19" Tall
- One piece, no sleeve or cap to replace.
- Drive over with cart and mowers in any direction and the force flex will bounce back up every time.
- Uv-resistant rod will not fade in the sun.
- Ground anchor sold separately
- Sold in sets of 12

STD15600	WHITE
STD15700	YELLOW
STD15800	RED
STD15900	BLUE
STD15500	ANCHOR

SOLD IN CASES OF 12



FLEXSTAKE HAZARD MARKERS

Mow Over in 2 Directions

FLXFG401-BU	BLUE 17.5"
FLXFG401-WH	WHITE 17.5"
FLXFG401-RD	RED 17.5"
FLXFG401-YW	YELLOW 17.5"
FLXFG402-BU	BLUE 24"
FLXFG402-WH	WHITE 24"
FLXFG402-YW	YELLOW 24"
FLXFG402-RD	RED 24"
FLXAN500	GROUND ANCHOR

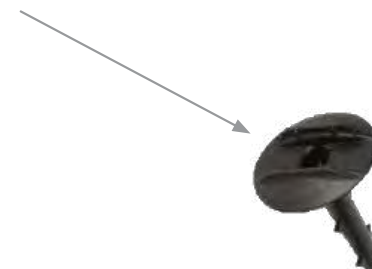

108 COURSE & YARDAGE MARKINGS

KIRBY FAIRWAY MARKERS



UV COATING

RAISED SURFACE



KBY-CO-__-__	MARKER COMPLETE WITH NUMBERS
KBY-CO-__-B	MARKER COMPLETE - NO NUMBERS
KBY-TP-__-__	TOP ONLY WITH NUMBERS
KBY-TP-__-B	TOP ONLY - NO NUMBERS
KBY-CL-__	COLLAR ONLY
KBYNL	REPLACEMENT LEAF W/ #
KBYPL	REPLACEMENT LEAF NO #
KBYAP-1	ANCHOR MOUNT PIPE
KBYAT-1	ANCHOR MOUNT TABS
KBYSC-C	MOUNTING SCREW FOR ANCHOR
KBYSC-T	MOUNTING SCREW FOR TOP CAP
KBYTC-1	TURF CUTTER FOR INSTALL
KBYPP-1	POUNDING PLATE FOR INSTALL

- Kirby Markers speeds up play by up to 36 minutes per foursome.
- Collapse under mowers, saving your crew from having to pull out fairway markers
- Mower-friendly, resulting in much less mower blade wear and tear
- Ability to withstand snow, rain, extreme heat, ice and mud.
- Kirby Markers require less maintenance than traditional markers, saving the course on daily maintenance.
- There are advertising possibilities created by Kirby Markers.

We can create any color/number combination as well as customization on collars like club logos, advertisers, sponsors, and more. Call us for a quote!

FAIRWAY YARDAGE POLES

2" Diameter x 60" Tall

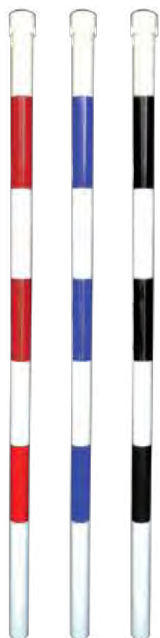

- Heavy duty PVC pole 1 1/2 in. diameter, 60 in. tall
- Includes PVC ground anchor for mounting.

PWFPST-BW	BLACK & WHITE
PWFPST-WB	BLUE & WHITE
PWFPST-RW	RED & WHITE



FAIRWAY MARKING POLES

4" Diameter x 48" Tall

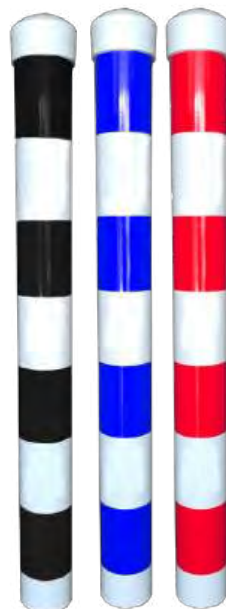

- Heavy duty PVC pole 4 in. diameter, 48 in. tall - not the thin, brittle pipe used by our competitors.
- Includes PVC ground anchor for mounting.
- Added due to popular demand from our customers!

PWFPST4-BW	BLACK & WHITE
PWFPST4-WB	BLUE & WHITE
PWFPST4-RW	RED & WHITE

Pricing is subject to change.

CUSTOM COURSE YARDAGE MARKERS



- 36" recycled lumber stake with 6" x 8" flag mounted inside the stake
- These are great yardage marker because they are tall and highly visible
- Comes with a sleeve for a permanent but can still easily be removed for mowing
- Flags can be custom logo if you buy 18 or more

- PWYPF-RD** YARDAGE POST - RED
- PWYPF-WH** YARDAGE POST - WHITE
- PWYPF-RB** YARDAGE POST - BLUE
- PWYPF-C** YARDAGE POST W/ CUSTOM FLAG

SOFT TOP MUSHROOM MARKERS



- 14" diameter
- Sits slightly above turf for greater visibility while depressing during mowing

- GCASTM01-RD** COMPLETE MARKER - RED
- GCASTM01-WH** COMPLETE MARKER - WHITE
- GCASTM01-RB** COMPLETE MARKER - BLUE
- GCASTM01T** REPLACEMENT TOP
- GCASTM01B** REPLACEMENT BOTTOM

PERMA CORE IN GROUND ROUND YARDAGE MONUMENTS

Comes With Two Stainless Steel Spikes
6", 8", 11" & 15" Options

- PWPCRN-YARDAGE- SIZE-COLOR** NUMBERED MONUMENT
- PWPCRN-C- SIZE-COLOR** CUSTOM MONUMENT
- PWPCRN-P- SIZE-COLOR** PLAIN MONUMENT

6" 8" 11" 15"

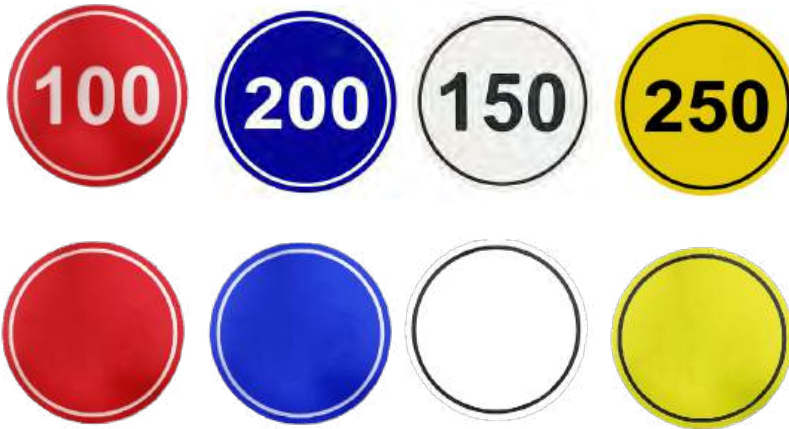

Call us for a quote for additional color options. Add logo to any marker above at additional cost.

PERMA CORE IN GROUND RECTANGLE YARDAGE MONUMENTS

Comes With Two Stainless Steel Spikes
8" X 12"

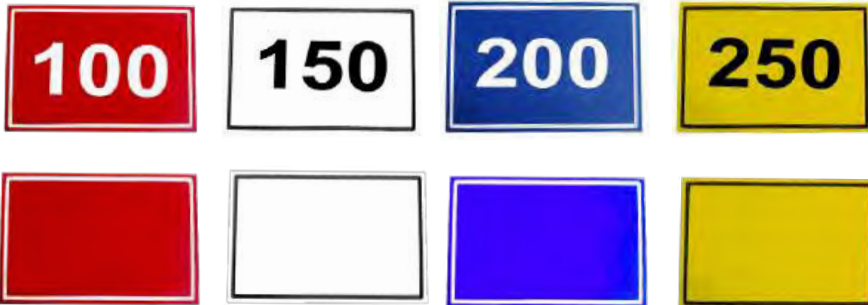

PERMA-CORE COLOR OPTION KEY



- PWPCRC-YARDAGE-COLOR** NUMBERED MONUMENT
- PWPCRC-C-COLOR** CUSTOM MONUMENT
- PWPCRC-P-COLOR** PLAIN MONUMENT

Call us for a quote for additional color options. Add logo to any marker above at additional cost.

110 COURSE & YARDAGE MARKINGS

BRONZE & ALUMINUM COLOR OPTION KEY



CART PATH YARDAGE MARKERS



BRONZE

ALUMINUM

**ALUMINUM W/
COLOR**

- Available in standard or custom yardages
- Includes two 2 1/2" (6 cm) zinc-plated, threaded studs
- Available in cast aluminum or cast bronze
- 9 inches long x 5.25 inches wide x 1.25 inches tall
- Cast Bronze - available with black or natural bronze background
- Cast Aluminum - available colors in color key above

PART NUMBER	MATERIAL	BACKGROUND	YARDAGE
PWPYZ-100-CL-RD	ALUMINUM	RED	100
PWPYZ-150-CL-WH	ALUMINUM	WHITE	150
PWPYZ-200-CL-BU	ALUMINUM	BLUE	200
PWPYZ-100-AL	ALUMINUM	BLACK	100
PWPYZ-150-AL	ALUMINUM	BLACK	150
PWPYZ-200-AL	ALUMINUM	BLACK	200
PWPYZ-250-AL	ALUMINUM	BLACK	250
PWPYZ-100-BZ-BK	BRONZE	BLACK	100
PWPYZ-150-BZ-BK	BRONZE	BLACK	150
PWPYZ-200-BA-BK	BRONZE	BLACK	200
PWPYZ-250-BZ-BK	BRONZE	BLACK	250
PWPYZ-100-BZ	BRONZE	DARK BRONZE	100
PWPYZ-150-BZ	BRONZE	DARK BRONZE	150
PWPYZ-200-BZ	BRONZE	DARK BRONZE	200
PWPYZ-250-BZ	BRONZE	DARK BRONZE	250
PWPYZ-C-BZ	BRONZE	CUSTOM	CUSTOM
PWPYZ-C-AL	ALUMINUM	CUSTOM	CUSTOM

BRONZE & ALUMINUM YARDAGE MARKERS



- In Ground Yardage Markers are an essential element of play for any golf course.
- Properly marked courses can speed the pace of play and make for a more enjoyable golf experience.
- Choose background color and yardage numbers you want
- Custom shapes and sizes are available - just call us

DESCRIPTION	PART NUMBER
6" ROUND BRONZE	PCMAC-06-BZ
6" ROUND ALUMINUM	PCMAC-06-AL
10" ROUND BRONZE	PCMAC-10-BZ
10" ROUND ALUMINUM	PCMAC-10-AL
6" X 8" BRONZE RECTANGLE	PCMAR-86-BZ
6" X 8" ALUMINUM RECTANGLE	PCMAR-86-AL
8" X 10" BRONZE RECTANGLE	PCMAR-18-BZ
8" X 10" ALUMINUM RECTANGLE	PCMAR-18-AL

CUSTOMIZE YOUR OWN CAST BRONZE & ALUMINUM YARDAGE MARKERS!



We can create any custom sizes/shape with custom logos on any Cast Bronze and Aluminum yardage markers with multiple finishes available. Call us for more options!

Pricing is subject to change.

RECYCLED LUMBER ROPE STAKES

- Premium recycled plastic stakes with beveled tops
- Choose speed slot, hole only or metal hook (for chain)
- Available in green, white, brown, or black
- 1.5" square



HUNTER GREEN

WHITE



BLACK

BROWN

12" STAKES

18" STAKES

24" STAKES

36" STAKES



SIZE	SPEED SLOT	HOLE ONLY	CHAIN HOOK
GREEN- 12"	PWRPS-400-12-SS	PWRPS-400-12-H	PWRPS-400-12-C
GREEN - 18"	PWRPS-400-18-SS	PWRPS-400-18-H	PWRPS-400-18-C
GREEN- 24"	PWRPS-400-24-SS	PWRPS-400-24-H	PWRPS-400-24-C
GREEN - 36"	PWRPS-400-36-SS	PWRPS-400-36-H	PWRPS-400-36-C
BLACK- 12"	PWRPS-800-12-SS	PWRPS-800-12-H	PWRPS-800-12-C
BLACK - 18"	PWRPS-800-18-SS	PWRPS-800-18-H	PWRPS-800-18-C
BLACK- 24"	PWRPS-800-24-SS	PWRPS-800-24-H	PWRPS-800-24-C
BLACK - 36"	PWRPS-800-36-SS	PWRPS-800-36-H	PWRPS-800-36-C
WHITE- 12"	PWRPS-200-12-SS	PWRPS-200-12-H	PWRPS-200-12-C
WHITE - 18"	PWRPS-200-18-SS	PWRPS-200-18-H	PWRPS-200-18-C
WHITE- 24"	PWRPS-200-24-SS	PWRPS-200-24-H	PWRPS-200-24-C
WHITE - 36"	PWRPS-200-36-SS	PWRPS-200-36-H	PWRPS-200-36-C
BROWN- 12"	PWRPS-700-12-SS	PWRPS-700-12-H	PWRPS-700-12-C
BROWN - 18"	PWRPS-700-18-SS	PWRPS-700-18-H	PWRPS-700-18-C
BROWN- 24"	PWRPS-700-24-SS	PWRPS-700-24-H	PWRPS-700-24-C
BROWN - 36"	PWRPS-700-36-SS	PWRPS-700-36-H	PWRPS-700-36-C



ELASTIC CORD ROPE
Deters Coyotes From Cutting Rope

1/4" ELASTIC CORD (500' SPOOL)

- GCAECRGR GREEN
- GCAECRWH WHITE
- GCAECRBL BLACK
- GCAECRGRWH GREEN/WHITE
- GCAECRYW YELLOW
- GCAECC CONNECTOR (100 PACK)- ALUMINUM



PLASTIC CHAIN

Premium Chain Made In The USA

- Chain gives you a different look than rope and can easily be repaired when broken (no splicing rope)
- Wildlife doesn't bite through chain like they do rope
- A better product than the cheap import chains
- U.V.-resistant materials that help us provide a five-year warranty against fading or becoming brittle.
- Made in the U.S.A.
- S-hooks & master links available

- GCAPC1.5-WH 1.5" X 500' LONG, WHITE
- GCAPC1.5-YW 1.5" X 500' LONG, YELLOW
- GCAPC1.5-BK 1.5" X 500' LONG, BLACK
- GCAPC2-WH 2" X 500' LONG, WHITE
- GCAPC2-YW 2" X 500' LONG, YELLOW
- GCAPC2-BK 2" X 500' LONG, BLACK
- GCAPC3-WH 3" X 300' LONG, WHITE
- GCAPC3-YW 3" X 300' LONG, YELLOW
- GCAPC3-WBK 3" X 300' LONG, BLACK

1/4 INCH GOLF COURSE ROPE



- The most common form of traffic control and our most popular rope option
- Use with our rope stakes
- Use the fid to avoid unsightly knots
- 1/4" hollow braid (1000' spool)

- GCARPGR GREEN
- GCARPWH WHITE
- GCARPYW YELLOW
- GCARPGRWH GREEN/WHITE
- GCARPBLK BLACK

1/2 INCH GOLF COURSE ROPE



- A thicker rope good to use with our 4" x 4" stakes in areas where it stays up permanently
- Hollow braid allows for fid use to hide any ugly knots
- 1/2" hollow braid (500' spool)

- GCARPGR1/2 GREEN
- GCARPWH1/2 WHITE
- GCARPYW1/2 YELLOW
- GCARPGRWH1/2 GREEN/WHITE
- GCARPBLK1/2 BLACK

RUBBER Mallet



SHPRM2

PLASTIC ROPE FID



- GCARPFID 1/4" FID
- GCARPFID5 1/2" FID

Pricing is subject to change.



TRAFFIC SIGNS

- PWALST1212 YELLOW DIAMOND 12" - ALUMINUM
- PWALST2424 YELLOW DIAMOND 24" - ALUMINUM
- PWALSTOP12 12" STOP SIGN - ALUMINUM
- PWALSTOP18 18" STOP SIGN - ALUMINUM
- PWALSTOP24 24" STOP SIGN - ALUMINUM
- PWPCSTOP-12 12" STOP SIGN - LAMINATE PLASTIC
- PWPCSTOP-18 18" STOP SIGN - LAMINATE PLASTIC
- PWPCSTOP-24 24" STOP SIGN - LAMINATE PLASTIC

*See page 26 for more sign post options.

CART PATH YARDAGE DOTS



- Use these cart path yardage dots to signify distance from green on the cart path or to mark hazard or ob boundaries on a cart path
- Non-reflective recycled polypropylene material
- install with epoxy resin or butyl pads
- Unique hexagon groove system for improved adhesion and strength
- Available in red, white or blue colors
- Size: 4" diameter x 3/4" tall
- Weight: 2 oz.

CART GUIDES



- Rubber guides attach to path to prevent carts from wearing the edges of turf out on turns
- Low maintenance and effective

FLXCG100 CART GUIDE



GORILLA MAX STRENGTH CLEAR CONSTRUCTION ADHESIVE
9 Ounce Cartridge

- Used to glue cart path guides on hard surfaces

GCAA9T

- GCAYBR RED
- GCAYBW WHITE
- GCAYBB BLUE

8" CART TRAFFIC STAKES - 25 STAKES
8" Stake w/ 4" Cap & Transport Bucket



- Easy to use – no rope or chain
- 8 Inch tall stakes with 4 inch long vinyl cap
- Choose from 8 color options
- Stakes come with transport bucket
- Surround irrigation repair or wet areas to prevent carts
- Use along cart paths to prevent wear
- Choose stakes with convenient carrying bucket or without to save money!

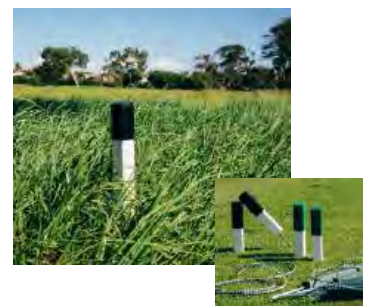

- PAR12250-25 GREEN CAP/WHITE STAKE
- PAR12252-25 BLACK CAP/WHITE STAKE
- PAR12251-25 RED CAP/WHITE STAKE
- PAR12253-25 BLUE CAP/WHITE STAKE
- PWQS-YB YELLOW CAP/BLACK STAKE
- PWQS-BW WHITE CAP/BLACK STAKE
- PWQS-WG WHITE CAP/GREEN STAKE
- PWQS-WB WHITE CAP/BROWN STAKE



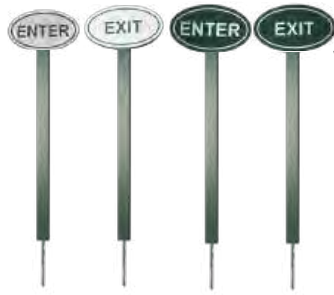

OVAL ENTER/EXIT SIGNS

10" x 7" Sign on 18" Sign Post



ENTER/EXIT SIGN COLOR OPTION KEY



PWPC-EN18- ENTER SIGN
PWPC-EX18- EXIT SIGN



VERTICAL ENTER/EXIT SIGNS

32" x 3.5"



ENTER/EXIT SIGN COLOR OPTION KEY



PWPC-EN- ENTER SIGN
PWPC-EX- EXIT SIGN



4" RECYCLED LUMBER TRAFFIC POSTS

RCPP4412-GN-H	12" GREEN - HOLE
RCPP4412-GN	12" GREEN - NO HOLE
RCPP4412-BR-H	12" BROWN - HOLE
RCPP4412-BR	12" BROWN - NO HOLE
RCPP4412-BK-H	12" BLACK - HOLE
RCPP4412-BK	12" BLACK - NO HOLE
RCPP4418-GN-H	18" GREEN - HOLE
RCPP4418-GN	18" GREEN - NO HOLE
RCPP4418-BR-H	18" BROWN - HOLE
RCPP4418-BR	18" BROWN - NO HOLE
RCPP4418-BK-H	18" BLACK - HOLE
RCPP4418-BK	18" BLACK - NO HOLE



- Posts used to divert or block traffic patterns
- Can be used with or without rope
- Comes with double spikes

SCATTER BOARDS

Cart Directional



- Place at the end of cart paths or where carts disperse into the fairways to spread the traffic pattern
- Low maintenance and effective
- Available in green, brown or black
- 48" Wide

RCPSB48-GN	GREEN
RCPSB48-BR	BROWN
RCPSB48-BK	BLACK

Customized with club logo option available



CONVEX SAFETY MIRROR

- Outdoor safety mirror with mounting hardware
- Safety essential for blind corners or can be used for blind tee shots
- Weather proof
- Mounts to wall or post
- Post not included

GCAMIRROR18	18" DIAMETER
GCAMIRROR26	26" DIAMETER
GCAMIRROR36	36" DIAMETER
GCAMIRROR48	48" DIAMETER

RUBBER SPEED BUMPS

- Commercial quality rubber speed bump
- Slow carts down on hills or high traffic areas
- Low maintenance
- Sturdy design will not wear out with use

GCASB4	4 FEET LONG
GCASB6	6 FEET LONG
GCASBEC	END CAP (ONE END)
GCASBH	MOUNTING HARDWARE



Speed bump pictured with caps

Custom options available.

Pricing is subject to change.

REPLACEMENT WINDSHIELDS



- Folding windshields for all major cart models
- Acrylic
- Clear or tinted options

CART MODEL MAKE	CLEAR	TINTED
CLUB CAR - PRECEDENT (2004+)	NIV10016	NIV10017
CLUB CAR - DS (2000+)	NIV6004	NIV6005
EZ-GO RXV (2008+)	NIV6018	NIV6018
EZ GO TXT (2014+)	NIV6911	NIV6912
YAMAHA DRIVE2 (2017+)	NIV09-020	NIV09-021
YAMAHA G29 (2007-2016)	NIV6014	NIV6015
YAMAHA G22 (2003, 2007)	NIV6008	NIV6009
YAMAHA G14 - G19 (1995-2002)	NIV6006	NIV6007



NIV13784 12 PACK COOLER - BLK

IGLOO COOLERS & MOUNTING BRACKETS

COOLER ONLY

BRACKET & COOLER MOUNTS

NIV13783 UNIVERSAL BRACKET & COOLER

NIV309440 EZ-GO RXV COOLER & MOUNTING BRACKET (2008 & UP)



CLUB CLEAN BLACK CLUB & BALL WASHER



- One plug chamber design allows for easier draining and cleaning
- Includes universal bracket and instructions for easy installation

NIV34141

TIRES & WHEELS

- Assemblies are tires mounted on rims with valve stem and fully inflated ready for use.

PART #	SIZE
NIV10990	WHEEL ONLY - 8 X 7 CENTER - 4 HOLE - WHITE
NIV1608	WHEEL ONLY - 8 X 7 CENTER - 4 HOLE - BEIGE
NIV14546	18 X 8.5-8 KENDA HOLE IN ONE TIRE ONLY
NIV41061	18 X 8.5-8 DURO TIRE ONLY
TIR1454A	KENDA TIRE W/ WHEEL MOUNT - WHITE
TIR4061A	DURO TIRE W/ WHEEL MOUNT - WHITE

KENDA ROUNDED EDGES W/ SAWTOOTH TREAD



DURO SAWTOOTH TREAD



FULL PALLET DISCOUNTS & FREE FREIGHT ON TIRES OR ASSEMBLIES



POUR CADDY

20 oz Stainless Steel Flask Set



20 OZ

VOLUME DISCOUNTS AND CUSTOM LOGOS ARE AVAILABLE!

- Available in 6 colors!
- Pour Caddy is your on the go barkeep - a 20 oz., double-walled, vacuum-insulated, stainless steel all-in-one outdoor flask that keeps your favorite beverage cold for up to 12 hours.
- features a flip-top liquor pour spout for precise pouring, a leak-proof cap removable base that cleverly conceals four hidden shot cups
- Adaptable flask also doubles as a cocktail shaker
- Designed to fit most cup holders
- 20 oz option can be customized with logo



GO CADDY VIBE CUPS

18 oz & 28 oz Options

- Available in 10 colors!
- Choose between a 3.7-watt Bluetooth Speaker, Power bank with two USB charging ports, or 10' radius light cup bases
- Double Walled 18/8 Stainless Steel Keep Drinks Cold & Hot Longer
- 1000mAh Battery For 5-6 Hours Of Playback Time
- Designed to fit most cup holders
- Both sizes can be customized with logo



18 OZ

28 OZ

VOLUME DISCOUNTS AND CUSTOM LOGOS ARE AVAILABLE!

116 GOLF CART PARTS & ACCESSORIES

REPLACEMENT KEYS

Ez-Go, Clubcar, Yamaha



NIV1919 EZ-GO TXT

NIV8053 EZ-GO RXV

NIV1920 CLUBCAR

NIV1922 YAMAHA

All keys sold in packs of 25
(Rxv keys sold in sets of 2)

CART IDENTIFICATION FLAGS

Custom Made Messages



- Includes flag, rod and mounting clip
- Clips onto any model of golf cart
- We will make any message you want
- Colors available - red, blue, green, yellow, white

DRECID ANY MESSAGE

TERRY VELOUR GOLF TOWELS

11" X 17" - For Carts



GCATT1117

GOLF CART KEY TAG



DREKT-BK BLACK

DREKT-GR GREEN

DREKT-BL BLUE

UTILITY VEHICLE TOOL RACKS

PLEASE NOTE:

You Must Buy the Receiver Bracket First for Each Item

Step #1 - Order STD27440 (one of each for each bracket you want)

note - Mobile Work Bench Requires Two Of These Brackets

Step #2 - Order brackets you want for your tools

- Outfit your utility vehicle with tool racks for ultimate efficiency
- Easily transport everything you need without damage, noise or losing the capacity of your bed
- Mounts to side and back of most utility vehicles
- Quick disconnect to switch, swap or remove racks when needed
- Universal bracket for ultimate customization

STD27400 HOSE BRACKET

STD27510 TRASH CAN WITH BRACKET - INCLUDES 23 GALLON TRASH CAN

STD27500 SMALL TRASH CAN WITH BRACKET - INCLUDES 4 GALLON BUCKET (NOT PICTURED)

STD27410 HOLE CUTTER BRACKET

STD27420 MOBILE WORK BENCH

STD27430 ROPE SPOOL BRACKET

STD27440 RECEIVER BRACKET - UNIVERSAL BRACKET - MUST BE PURCHASED WITH EACH ABOVE UNIT

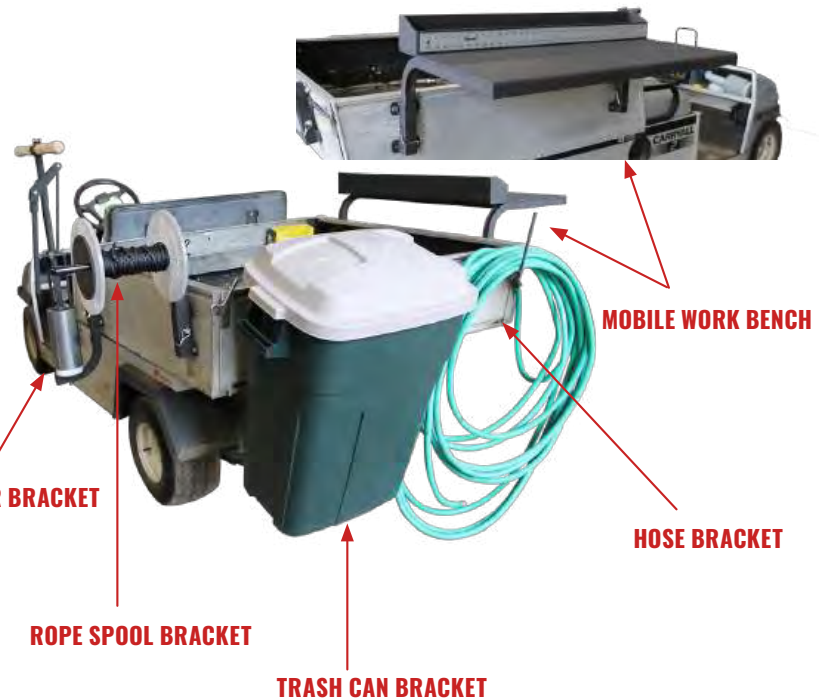

CUP CUTTER BRACKET

ROPE SPOOL BRACKET

TRASH CAN BRACKET

MOBILE WORK BENCH

HOSE BRACKET

CREW CADDY



PAR1038

HOLE CUTTER CARRIER



PAR1011

*EZGO ST350 4-CYCLE DELUXE TUNE UP KIT

w/ Oil Filter (Years 1996-Up)



NIV9306

*We carry tune up kits for all makes and models!

Pricing is subject to change.

SAFETY GLASSES

Diamondback Style



SAF540-0201 TINTED
SAF540-0200 CLEAR
SAF540-0205 YELLOW

SAFETY GLASSES

Hornets



SAF5270 CLEAR
SAF5276 TINTED

DELUXE FACE SHIELD

Replaceable Lens



SAF5145 FACE SHIELD W/ HEAD GEAR
SAF5155 REPLACEMENT SHIELD

FULL PROTECTION GLASSES

Meets ANSI Z87.1 & CSA Z94.3



SAF5120

SAFETY GOGGLES

Chemical Splash Resistant



SAFS3960D

NUISANCE DUST MASK



SAF2985 BOX OF 50

3M PARTICULATE RESPIRATORS

P95 Disposable Masks



SAF8271 BOX OF 10 - P95 - W/ VALVE



FULL RESPIRATOR

DUAL CARTRIDGE RESPIRATOR

Organic Vapor / R95

- Universal nose fit
- Large sealing surface for excellent fit
- Advanced yoke design for a secure comfortable non-slip fit
- Includes: 1-face piece, 2-OV/N99/R95 particulate filters and 2-retainers

REPLACEMENT OV
CARTRIDGE



REPLACEMENT R95 FILTER



SAF311-3215 LARGE RESPIRATOR

REPLACEMENT PARTS

SAF300-1001 OV CARTRIDGE
(PACK OF 6)

SAF300-1070 R 95 FILTERS
(PACK OF 12)

SAF1400-96 MASK WIPES
(CASE OF 100)

EAR PLUGS



SAF6100 BOX OF 200

CORDED EAR PLUGS



SAF6101-B BOX OF 100

EAR PLUG DISPENSER



SAF6844 250 COUNT
SAF6845 500 COUNT

EAR MUFFS

NRR 30



SAF6111

ISOTUNES FREE 2.0 NOISE-ISOLATING BLUETOOTH EARBUDS

25 dB NRR



- New & Improved ANSI-certified 25 dB NRR
- New & Improved Bluetooth 5.2
- OSHA Compliant hearing protection
- True wireless technology
- SafeMax™ Technology limits volume output to 85 dB
- Up to 7-hour battery life

SAFIT-73 MATTE BLACK
SAFIT-74 ISO GREEN

ISOTUNES ISOTUNES XTRA 2.0 NOISE-ISOLATING BLUETOOTH EARBUDS

27 dB NRR



- Magnetic multi-function earbuds
- Redesigned controller with larger, more pronounced buttons
- ANSI-certified 27 dB NRR
- OSHA-compliant hearing protection
- SafeMax™ Technology limits volume output to 85 dB
- Up to 11-hour battery life

SAFIT-27 MATTE BLACK
SAFIT-22 SAFETY YELLOW/BLACK

HARD HAT NECK SHADE



SAF690-1715

CHAINSAW PROTECTIVE VISOR AND EAR MUFFS



SAF7160-73
MOUNTS TO HARD HAT SAF7160-45

FULL BRIM HARD HAT
ANSI Certified



SAF7160-10 WHITE

FRONT BRIM HARD HAT
ANSI Certified



SAF7160-45 WHITE
SAF7160-46 YELLOW

MESH SUN HELMET
Good For Hot Climates



SAFHST

SAFARI GOLF HELMETS



SAFHW WHITE
SAFHT TAN

SIDE VENTED SUN HELMET



- SAFSHT
- Includes logo at no extra charge
 - Minimum order of 16 w/ logo

Pricing is subject to change.

ASTRO-GRIP DISPOSABLE GLOVES

Box of 100 Orange Gloves



- 100 gloves per box
- Thickness: 7mil
- Great in wet or dry conditions
- Powder-free exam grade nitrile
- Dual-sided cube grip

SAF6607-20 MEDIUM

SAF6608-20 LARGE

SAF6609-20 XL

RAVEN DISPOSABLE GLOVES

Box of 100 Black Gloves



- 100 gloves per box
- Thickness: 6mil
- Outstanding strength, wear and dexterity
- Comfortable for wear
- Textured for excellent chemical resistance and great grip
- Latex and powder free

SAF66517 MEDIUM

SAF66518 LARGE

SAF66519 XL

LINED LEATHER GLOVES



- Great for cold weather outdoor work
- Withstands moisture
- Soft pigskin lined with fleece

SAFGLDL-M MEDIUM

SAFGLDL-L LARGE

LEATHER DRIVER'S GLOVES



- Great for equipment operators
- Good balance of protection and dexterity
- Cowhide leather

SAFGLD-M MEDIUM

SAFGLD-L LARGE

LEATHER PALM GLOVE WITH SAFETY CUFF



SAFGLLP ONE SIZE FITS ALL

MAXIFLEX GLOVES

Protection & Flexibility



- Micro-foam nitrile coatings are compatible with light oils and will provide a good grip and excellent abrasion resistance
- Form, fit and feel - mimics the "hand at rest", reducing hand fatigue and increasing comfort

SAFGLJM-M MEDIUM

SAFGLJM-L LARGE

SAFGLJM-XL XL

MECHANIC'S GLOVES



- Excellent dexterity and flexibility for intricate work
- Outstanding gripping power
- Great protection against blisters, cuts and abrasions
- Stretch top for great flexibility and ease of movement
- Machine washable

SAF6652 MEDIUM

SAF6653 LARGE

SAF6654 XL

SAF6655 XXL

KEVLAR CHAINSAW GLOVES



- Foam padding on palms reduces vibrations
- Features 2 layers of Kevlar for cut resistance/protection
- 100% goatskin leather on palm for firm grip
- Reinforced fingertips and knuckles for durability

ECH99988801600 MEDIUM

ECH99988801601 LARGE

ECH99988801602 XL

ECH99988801603 XXL



NITRILE CHEMICAL GLOVES



- Premium unsupported nitrile
- 15-Mil, green
- Unlined
- Embossed grip

SAFGLC - 9 SIZE 9
SAFGLC - 10 SIZE 10

CHEMICAL MIXING APRON



- Excellent splash protection against most mild chemicals
- Adjustable neckstrap
- 100% waterproof
- Longer length extends coverage (35" W x 47" L)
- One size fits most

SAF6821 APRON

TYVEK SPRAY SUITS
400 Series Coveralls



120 Series

- Open wrists & ankles
- No hood
- Case of 25 suits

122 Series

- Elastic wrists & ankles
- With hood
- Case of 25 suits

125 Series

- Elastic wrists & ankles
- No hood
- Case of 25 suits

SAFTY120-M MEDIUM

SAFTY120-L LARGE

SAFTY120-XL XL

SAFTY120-2X 2 XL

SAFTY120-3X 3 XL

SAFTY120-4X 4 XL

SAFTY122-M MEDIUM

SAFTY122-L LARGE

SAFTY122-XL XL

SAFTY122-2XL 2XL

SAFTY125-M MEDIUM

SAFTY125-L LARGE

SAFTY125-XL XL

SAFTY125-2X 2 XL

SAFTY125-3X 3 XL

MEASURING CUP SET



IRRMCSSET 5 CUP COMPLETE SET
IRRMCS8 8 OZ MEASURING CUP
IRRMCS16 16 OZ MEASURING CUP
IRRMCS32 32 OZ MEASURING CUP
IRRMCS64 64 OZ MEASURING CUP
IRRMCS128 128 OZ MEASURING CUP

PVC GLOVE



- 14" length
- Double-dip anti-slip rough finish
- Specially formulated for solvents such as lacquer thinner and parts wash solutions
- Knit interlock liner

SAF6553- LARGE SAF6554- EXTRA

HAZARDOUS MATERIALS DIAMOND SIGNS

OSHA Compliant



- Complete kit available on a 12" x 12" Aluminum sign or as a vinyl decal kit
- Each kit comes with 3 of each number 0-4 and 1 of each word/symbol - oxy, al acid, W

PWALS1212-205 12" ALUMINUM SIGN KIT

PWVL-NUM NUMBER & SYMBOL KIT ONLY

PORTABLE EYE WASH STATION



- One-hand operation
- Gravity fed, no plumbing required
- Holds 9 gallons of water
- 15-minute flow time
- Measures: 9.5" x 16.5" x 20.15"
- Includes: mounting bracket, inspection tag and preservative
- Change water every 90 days

SAF5134-00 EYEWASH STATION

EYEWASH SOLUTION STATION



- Temporary first-aid
- Great for spray rigs
- Durable plastic station includes 2-16 oz. bottles
- Bottles have twist-off tops with protective seals
- Directions printed on station for fast reference

SAF5132 EYEWASH SOLUTION STATION

SAF5130 REPLACEMENT SOLUTION

OUTDOOR SAFETY SELF DRAINING SHOWER W/ Open Eye Wash



- Use outdoors, in warm climates with a maximum ambient operating temperature of 113°F (45°C) or below
- Self-draining valve allows standing water to drain away from the standpipe ensuring the delivery of tepid water
- Includes a universal safety shower sign for enhanced visibility
- Meets ANSI Z358.1 2014 and EN 15154 standards, supports OSHA requirements

SAFSD18G85G GALVANIZED STATION

SAFSD18GS85G STAINLESS STEEL STATION

INDUSTRIAL FIRST AID KIT Metal Case



SAF6025-01 25 PERSON

SAF6050-01 50 PERSON

DELUXE KNEE PADS

Plastic Cap Over Tough Nylon Fabric



SAF7102

BACK SUPPORT BELT

4 Plastic Stays for Flexible, Contoured Support



SAF7161 SMALL (26"-32")

SAF7162 MEDIUM (32"-38")

SAF7163 LARGE (38"-47")

SAF7164 XL (46"-56")

SAF7165 XXL (54"-58")

GREENKEEPER LED HEADLAMP

Rechargeable With Zoom Feature



SHPHLR HEADLAMP



KUJO YARD SHOE
Water Resistant Design For A Superintendent

- PWKYS-GG-** GRAY/GREEN
- PWKYS-DS-** DESERT SAND
- PWKYS-BG-** BLACK/GREEN



GREY & GREEN



DESERT SAND



BLACK & GREEN

See size chart below for available options.

NEW PRODUCT!

KUJO SURGE RUBBER BOOT
Water Resistant Design For A Superintendent

Introducing the Kujo Surge Rubber Boot – your ultimate ally against wet, slippery, and challenging terrains! Engineered for durability and comfort, these boots are 100% waterproof with a slip-resistant Turf-Grip outsole for unbeatable traction.

PWKRB-G-**



KUJO JAX
Water Resistant Pull-On Shoes

- PWKJS-BG-** BLACK & GREY
- PWKJS-GB-** GREY & BLUE
- PWKJS-RG-** GREY & RED



BLACK & GREY



GREY & BLUE



GREY & RED

ADD SIZE AFTER PART #.
SIZE 5, 5.5, 6, 6.5 NOT AVAILABLE FOR BOOTS.

SIZE 5	SIZE 10
SIZE 5.5	SIZE 10.5
SIZE 6	SIZE 11
SIZE 6.5	SIZE 11.5
SIZE 7	SIZE 12
SIZE 7.5	SIZE 13
SIZE 8	SIZE 14
SIZE 8.5	

KUJO X1 LANDSCAPE BOOT
Water Resistance & Safety

- PWKYB-B-** BLACK
- PWKYB-DS-** DESERT SAND



DESERT SAND



GREY & GREEN

Pricing is subject to change.

NEW PRODUCT!

**ADD SIZE AFTER PART #.
SIZE 5, 5.5, 6, 6.5 NOT
AVAILABLE FOR BOOTS.**

Experience year-round performance with these light-weight, soft-toe work shoes designed for comfort and durability. Featuring a waterproof liner, durable ripstop upper, and a rugged rubber turf grip outsole, they provide superior protection and support for any task.

- SIZE 5 SIZE 10
- SIZE 5.5 SIZE 10.5
- SIZE 6 SIZE 11
- SIZE 6.5 SIZE 11.5
- SIZE 7 SIZE 12
- SIZE 7.5 SIZE 13
- SIZE 8 SIZE 14
- SIZE 8.5



KUJO X4S WATERPROOF BOOT
Water Resistance & Safety

PWKRB-G-**



KUJO YARD PANTS & SHORTS

Hardworking, Flexible, And Comfortable Yard Work Apparel

- PWKP900**** CHARCOAL PANTS
- PWKP90010**** DESERT SAND PANTS
- PWKP90020**** GREY SHORTS
- PWKS91010**** DESERT SAND SHORTS

**SIZES
AVAILABLE**

- 32" X 32"**
- 34" X 30"**
- 34" X 32"**
- 34" X 34"**
- 36" X 32"**
- 36" X 34"**
- 38" X 32"**



CHARCOAL PANTS

DESERT SAND PANTS

GREY SHORTS

DESERT SAND SHORTS

HELLY HANSEN MANDAL

Rain Bib



- En 343 3,1 waterproof
- 100% Polyester waterproof fabric and construction
- Inner chest pocket with zipper
- Adjustable elastic suspenders

HELLY HANSEN MANDAL

Rain Jacket



- En 343 3,1 waterproof
- 100% Polyester PVC coated waterproof fabric
- Hood with draw cord adjustment
- Storm flap & two hand pockets

HELLY HANSEN MANDAL

Pants



- En 343 3,1 waterproof
- 100% Polyester, pvc coated waterproof fabric
- Elastic at waist
- Push button adjustment at hem & waist

SAF70529-480S	GREEN - SM
SAF70529-480M	GREEN - MD
SAF70529-480L	GREEN - LG
SAF70529-480XL	GREEN - XL
SAF70529-4802X	GREEN - 2X
SAF70529-4803X	GREEN - 3X
SAF70529-310S	YELLOW - SM
SAF70529-310M	YELLOW - MD
SAF70529-310L	YELLOW - LG
SAF70529-310XL	YELLOW - XL
SAF70529-3102X	YELLOW - 2X
SAF70529-3103X	YELLOW - 3X

SAF70129-480S	GREEN - SM
SAF70129-480M	GREEN - MD
SAF70129-480L	GREEN - LG
SAF70129-480XL	GREEN - XL
SAF70129-4802X	GREEN - 2X
SAF70129-4803X	GREEN - 3X
SAF70129-310S	YELLOW - SM
SAF70129-310M	YELLOW - MD
SAF70129-310L	YELLOW - LG
SAF70129-310XL	YELLOW - XL
SAF70129-3102X	YELLOW - 2X
SAF70129-3103X	YELLOW - 3X

SAF70429-480S	GREEN - SM
SAF70429-480M	GREEN - MD
SAF70429-480L	GREEN - LG
SAF70429-480XL	GREEN - XL
SAF70429-4802X	GREEN - 2X
SAF70429-4803X	GREEN - 3X
SAF70429-310S	YELLOW - SM
SAF70429-310M	YELLOW - MD
SAF70429-310L	YELLOW - LG
SAF70429-310XL	YELLOW - XL
SAF70429-3102X	YELLOW - 2X
SAF70429-3103X	YELLOW - 3X

CHEST WADERS



- Built-in belt loops with adjustable belt
- Excellent cold weather flexibility
- Durable, heavy duty nylon PVC upper with polyester backing
- Adjustable polyester nylon strap
- Top drawstring closure for snug fit
- Non-absorbent lining
- 35% lighter most chest waders

PART #	SHOE SIZE
SAF860660900	9
SAF860661000	10
SAF860661100	11
SAF860661200	12
SAF860661300	13

PVC KNEE BOOTS

Profile Plain & Safety Toe Options



PLAIN - \$48.50	SIZE	SAFETY - \$55.00	SIZE
SAF511546	6	SAF512546	6
SAF511547	7	SAF512547	7
SAF511548	8	SAF512548	8
SAF511549	9	SAF512549	9
SAF5115410	10	SAF5125410	10
SAF5115411	11	SAF5125411	11
SAF5115412	12	SAF5125412	12
SAF5115413	13	SAF5125413	13

- 100% liquid proof
- 15" Ht. with a cutline at 12" to facilitate fast and clean height modification
- Outsole material is soft for excellent slip resistance and absorbs shock when walking
- Cleated outsole spits out debris for excellent gripping action on various surfaces
- Steel toe available- special order

Pricing is subject to change.

STORM CHAMP RAIN SUITS

Includes Pants & Jacket



- 2-Piece suit made of .20mm PVC on nylon
- Lightweight, soft and generously cut
- Zipper front jacket, hook & loop take-up straps
- Plain front waist pants; pockets

SAFS66211-MD GREEN - MD

SAFS66211-LG GREEN - LG

SAFS66211-XL GREEN - XL

SAFS66211-XXL GREEN - XXL

SAFS66218-MD BLUE - MD

SAFS66218-LG BLUE-LG

SAFS66218-XL BLUE-XL

SAFS66218-XXL BLUE-XXL

SUNSCREEN

1 Gallon With Pump

- SPF 50
- Contains vitamins which UVA/ UVB Broad Spectrum Protection and shield skin against harmful damage from both UVA and UVB rays.
- Proudly made in USA, Chemical-Free, Paraben-Free Preservative System and fast-absorbing

SAFSS1G

**GOJO HAND CLEANER**

- Gojo natural orange pumice hand cleaner contains quick-acting lotion formula with pumice scrubbing particles
- Cleans a broad range of industrial soils, medium dirt and grease
- Orange citrus scent
- Natural citrus ingredients

SHP752-940 1/2 GAL DISPENSER

SHP752-944 1 GAL DISPENSER

**TINGLEY OVERSHOES**

Wider Fit For Boots



- Enlarged sizing for the bulkiest of work shoes and boots.
- 100% waterproof protection.
- Will not crack or stiffen in the coldest of weather.
- Deep cleated outsole spits out debris for good slip resistance and longer wear.
- Comes packed in box

SAF1300M MEDIUM

SAF1300L LARGE

SAF1300XL XL

TINGLEY OVERSHOES

Classic Fit



- Classic sizing best for sneakers and work shoes
- 100% waterproof protection.
- Will not crack or stiffen in the coldest of weather.
- Deep cleated outsole spits out debris for good slip resistance and longer wear.
- Comes packed in a bag

SAF2300S SMALL

SAF2300M MEDIUM

SAF2300L LARGE

SAF2300XL XL

SAF2300G XXL

CHAINSAW CHAPS

ECH99988801302
36" FULL WRAP CHAINSAW CHAPS
THIS SIZE FITS WAISTS 30" - 42"

FEATHERWEIGHT 3/4" & 1" ULTRAMAX HOSE

For The Professional Turf Manager

**ONLY WEIGHS
15 LBS!**



3/4" HOSE PART # 1" HOSE PART #

50 FEET	IRRH75-050FW	IRRH10-050FW
75 FEET	IRRH75-075FW	IRRH10-075FW
100 FEET	IRRH75-100FW	IRRH10-100FW
125 FEET	IRRH75-125FW	IRRH10-125FW

FEATHERWEIGHT 3/4" PROLINE HOSE

**ONLY WEIGHS
9 LBS!**



IRRH75-050PRO-FW	3/4" X 50 FEET
IRRH75-075PRO-FW	3/4" X 75 FEET
IRRH75-100PRO-FW	3/4" X 100 FEET

ULTRAMAX RED HOSE

Abrasive Resistant, Heavy Duty

SUPER STRONG



- 800 psi burst pressure rating
- Heavy duty, long lasting
- Abrasive resistant
- Holds up to dragging

IRRH75-025R	3/4" X 25'
IRRH75-050R	3/4" X 50'
IRRH75-075R	3/4" X 75'
IRRH75-100R	3/4" X 100'
IRRH75-125R	3/4" X 125'
IRRH10-050R	1" X 50'
IRRH10-075R	1" X 75'
IRRH10-100R	1" X 100'
IRRH10-125R	1" X 125'

ULTRAMAX BLUE HOSE

Our Best Hose

PREMIUM



- 1200 psi burst pressure rating
- Ultra flexible
- Lightweight - 45% lighter than other professional, heavy duty hoses
- Smooth finish

IRRH75-S10	3/4" X 10' SHORTY
IRRH75-S20	3/4" X 20' SHORTY
IRRH75-050B	3/4" X 50'
IRRH75-075B	3/4" X 75'
IRRH75-100B	3/4" X 100'
IRRH75-125B	3/4" X 125'
IRRH10-S10	1" X 10' SHORTY
IRRH10-S20	1" X 20' SHORTY
IRRH10-050B	1" X 50'
IRRH10-075B	1" X 75'
IRRH10-100B	1" X 100'
IRRH10-125B	1" X 125'

ULTRAMAX GREEN HOSE

800 PSI, Tough Outer Wall

ECONOMY-PLUS



- 800 psi burst pressure rating
- Very smooth finish
- Lightweight

IRRH75-050G	3/4" X 50'
IRRH75-075G	3/4" X 75'
IRRH75-100G	3/4" X 100'
IRRH75-125G	3/4" X 125'
IRRH10-050G	1" X 50'
IRRH10-075G	1" X 75'
IRRH10-100G	1" X 100'



PROLINE PURPLE SERIES HOSE

Economical Multi-Purpose Hose



- Economical multi-purpose hose solution with the same construction specifications as our popular Proline Gold Series hose.
- 500 psi Burst Pressure
- ZERO-KINK technology
- Machined Brass couplings
- Lightweight and durable
- 20.2 lbs. (9.2kg)

IRRH75-050PRO-P	3/4" X 50'
IRRH75-075PRO-P	3/4" X 75'
IRRH75-100PRO-P	3/4" X 100'

PWALS1218-101 12"X18" RECYCLED WATER SIGN

PROLINE GOLD SERIES HOSE



- Affordable choice
- Commercial grade outer material, flexible, light-weight, and crush-proof hose
- Outstanding durability
- Machined brass hose ends
- Made in the USA

IRRH75-050PRO-G	3/4" X 50'
IRRH75-075PRO-G	3/4" X 75'
IRRH75-100PRO-G	3/4" X 100'

ULTRAMAX CLEAR HOSE

Lightweight & Economical



IRRH75-050C	3/4" X 50'
IRRH75-075C	3/4" X 75'
IRRH75-100C	3/4" X 100'
IRRH75-125C	3/4" X 125'
IRRH10-50C	1" X 50'
IRRH10-75C	1" X 75'
IRRH10-100C	1" X 100'
IRRH10-125C	1" X 125'

Pricing is subject to change.

HOSE CADDIE™ & HOSE CADDIE™ TRAILER

- Strongest Durable Hose Trailer on the Market
- Packaged for Minimal Shipping Expense
- Full Size Golf Cart Tires & Hubs
- 10' Leader Hose Included ONLY*
- Replacement Parts Available
- Includes Convenient Quick Coupler Key Mount
- Optional Steel Tool Box Available

*Premium long hoses are not included with purchase. See hose options on page 125

- IRRHC-TRL-075** 3/4" MODEL W/TRAILER
- IRRHC-TRL-100** 1" MODEL W/TRAILER
- IRRHC-075** 3/4" MODEL CADDIE ONLY
- IRRHC-100** 1" MODEL CADDIE ONLY



HOSE CADDIE™



POWER-SPLITTER 2-Way Hose Tap Splitter



- Finally the high quality, high flow hose splitter you've been waiting for
- Large brass ergonomic handles for easy flow control
- Full size golf cart tires & hubs
- Larger ports allow for full flow rates over 30 gpm
- All brass & stainless steel construction for ultimate durability

IRRA-HB2HF

TWIST-EASE KINK ELIMINATOR Irrigation Hose Swivel



NEVER FIGHT WITH A TANGLED HOSE AGAIN!

- IRRHSF-75** 3/4" KINK ELIMINATOR
- IRRHSF-100** 1" KINK ELIMINATOR

BANDIT Hose Repair Tool



- Used to apply BAND-IT 3/8" and 5/8" Center Punch Clamps
- Ratchet the clamp tight and hit with a hammer to secure clamp

IRRB1

FAST-LOK CLAMP TOOL



IRRF38

HOSE WORM CLAMPS



- IRRHWC-050-125** 1/2" - 1.25" OD
- IRRHWC-075-175** 3/4" - 1.75" OD

STAINLESS STEEL BANDS Used for Clamp Tools



- IRRSHC5/8** 5/8" STAINLESS BAND
- IRRSHC3/8** 3/8" STAINLESS BAND



128 IRRIGATION & WATERING

QUICK COUPLER VALVES

One Piece With Rubber Top



3/4" VALVE

1" VALVE

1.5" VALVE

- Red Brass
 - Interchanges with Rain Bird, Toro, Hunter & Buckner
 - Stainless Steel Accessories
 - Spring Loaded Vinyl Covers
- IRRQV-075** 3/4" VALVE
IRRQV-100 1" VALVE
IRRQV-150 1.5" VALVE

QUICK COUPLER VALVES

Two Piece w/ Rubber Top



1.5" VALVE

1" VALVE

- Red Brass
 - Interchanges with Rain Bird, Toro, Hunter & Buckner
 - Stainless Steel Accessories
 - Spring Loaded Vinyl Covers
- IRRQV-075-2P** 3/4" VALVE
IRRQV-100-2P 1" VALVE



SINGLE PIECE BODY - BRASS KEY COUPLERS		CROSS REFERENCE CHART			
UNDERHILL MODEL NO.	DESCRIPTION	BUCKNER	RAIN BIRD	TORO	HUNTER
IRRQV-075	3/4" QUICK COUPLER W/ YELLOW RUBBER COVER	QCV075R	3RC	473-01	N/A
IRRQV-100	1" QUICK COUPLER W/ YELLOW RUBBER COVER	QCV0100R	33DRC	473-21	N/A
IRRQV-125	1.5" QUICK COUPLER W/ YELLOW RUBBER COVER	QCV0151R	N/A	476-01	N/A
TWO-PIECE BODY - BRASS KEY COUPLERS		CROSS REFERENCE CHART			
UNDERHILL MODEL NO.	DESCRIPTION	BUCKNER	RAIN BIRD	TORO	HUNTER
IRRQV-075-2P	3/4" QUICK COUPLER W/ YELLOW RUBBER COVER	QB33RC07	44KA	N/A	N/A
IRRQV-100-2P	1" QUICK COUPLER W/ YELLOW RUBBER COVER	QB44RC10	44-RC	100-2SLVC	HQ-44

THE CLAW

Prevents quick couplers from turning when using the quick coupler key

IRRQCA-075100
3/4" and 1" valves

IRRQCA-150
1 1/2" valves

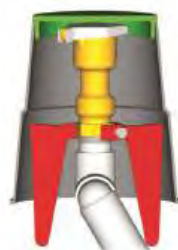

EASY RETROFIT! Installs Without Removing Valve or Valve Box - Fits in 6" Round Box or Larger!

REPLACEMENT O-RINGS

Sprinkler Internal O-Rings



IRROR-100 1" INLET TORO OR RAINBIRD 700 SERIES

IRROR-150 1.5" INLET TORO HEADS

IRROR-150RB 1.5" INLET RAINBIRD HEADS

HOSE TAP

Rainbird Or Toro Adapters

- Convert any head into a quick coupler
- Choose sizes for Toro or Rainbird heads
- Easy to use, just pull internal and insert hose tap

IRRHN-T100 TORO 1" INLET HEADS W/OUT SWIVEL

IRRHN-T100S TORO 1" INLET HEADS WITH SWIVEL

IRRHN-T150 TORO 1.5" INLET HEADS W/OUT SWIVEL

IRRHN-T150S TORO 1.5" INLET HEADS WITH SWIVEL

IRRHN-R125 RAINBIRD W/OUT SWIVEL

IRRHN-R125S RAINBIRD WITH SWIVEL

IRRHN-R150 RAINBIRD 900 SERIES W/OUT SWIVEL

IRRHN-R150S RAINBIRD 900 SERIES W/ SWIVEL



IRRHN-T150S



IRRHN-T150S

Pricing is subject to change.

QUICK COUPLER KEY SINGLE LUG



- Single lug key
- Rainbird 33 or toro 473 valve compatible
- 3/4" top mpt
- Swivel sold separately

IRRQK-075

QUICK COUPLER KEY SINGLE LUG



OUR MOST POPULAR

- Single lug key
- Rainbird 44 or toro 474 valve compatible
- 1" top mpt
- Swivel sold separately

IRRQK-100

SINGLE LUG QUICK COUPLER KEY



- Single lug key
- Rainbird 77 or toro 476 compatible
- 1.5" top mpt x 1.5" bottom
- Swivel sold separately

IRRQK-150

ACME QUICK COUPLER KEY



- Acme thread key
- Toro 474 or rainbird 4k-acme compatible
- 1" top mpt
- Swivel sold separately

IRRQB44KAT10

DOUBLE LUG QUICK COUPLER KEY

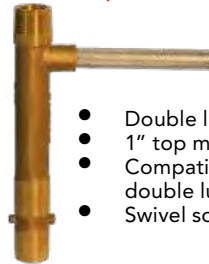

- Double lug key
- 1" top mpt
- Compatible w/ buckner double lug valves
- Swivel sold separately

IRRQB55K10

RAINBIRD 55K QUICK COUPLER KEY



- Single lug key
- Rainbird 55 or toro 475 valve compatible
- 1" top mpt
- Swivel sold separately

IRRRB55K

BRASS QUICK COUPLER KEYS (SINGLE LUG)		CROSS REFERENCE CHART			
UNDERHILL MODEL NO.	DESCRIPTION	BUCKNER	RAIN BIRD	TORO	HUNTER
IRRQK-075	¾" MPT X ½" FPT KEY	Q33K07	33DK	463-01	N/A
IRRQK-100	1" MPT X ¾" FPT KEY	QB44K10	44K	464-01	HK-44
QK-125	1" MPT X ¾" FPT KEY	QB5RK10	55K	465-01	N/A
QK-150	1½" MPT X 1¼" FPT KEY	N/A	N/A	N/A	N/A
QK-150RBTB	1 ½" MPT X 1 ¼" FPT KEY	QC151	7K	466-01	N/A
QK-100AT	1" MPT X ¾" FPT ACME THREADED KEY	QB44KAT10	44KA	464-03	HK-44

THE EXTENDER

Quick Coupler Key Extender for Low Valves



Now finally a solution for buried Quick Coupler Valves with difficult to open keys. No more having to dig up and raise the valve to make the key operational.

- Three models available to extend any Quick Coupler Key – ¾", 1", and 1 ½"
- The Extender raises the Quick Coupler Key an additional 4"
- Solid Brass with built-in handle

IRRQK-075EX ¾" FPT X ¾" MPT

IRRQK-100EX 1" FPT X 1" MPT

IRRQK-150EX 1.5" FPT X 1.5" MPT

HOSE SWIVELS



IRRHS-075 ¾" FPT X ¾" MHT

IRRHS-100 1" FPT X ¾" MHT

IRRHS-101 1" FPT X 1" MHT

IRRHS-151 1½" FPT X 1" MHT

REPLACEMENT O-RINGS

Sprinkler Internal O-Rings



- IRROR-100** 1" INLET TORO OR RAINBIRD 700 SERIES
- IRROR-150** 1.5" INLET TORO HEADS
- IRROR-150RB** 1.5" INLET RAINBIRD HEADS



HOSE TAP

- IRRHN-T100** TORO 1" INLET HEADS W/OUT SWIVEL
- IRRHN-T100S** TORO 1" INLET HEADS WITH SWIVEL
- IRRHN-T150** TORO 1.5" INLET HEADS W/OUT SWIVEL
- IRRHN-T150S** TORO 1.5" INLET HEADS WITH SWIVEL
- IRRHN-R125** RAINBIRD W/OUT SWIVEL
- IRRHN-R125S** RAINBIRD WITH SWIVEL
- IRRHN-R150** RAINBIRD 900 SERIES W/OUT SWIVEL
- IRRHN-R150S** RAINBIRD 900 SERIES W/ SWIVEL

DOUBLE HEADER SELECTOR KEY

Use On Both Toro & Rainbird



- Simple to use key turns on and off either Toro or Rainbird valve in head sprinklers
- Extra flat point for cleaning out key area on head
- Give to entire crew to keep on their key chains
- Package of 9 keys

IRRA-DH PACKAGE OF 9 KEYS

EZ REACH KEYS



- Extra long and extra heavy duty metal key designed for easy on/off operation for Toro, Rainbird and John Deere/Signature electric valve-in-head golf sprinklers.
- Made of high grade metal, EasyReach offers years of effortless on/off operation.

IRRA-ERR RAINBIRD KEY

IRRA-ERT TORO KEY

PELLET PRO

Quick Coupler Mount

- Pellet pro threads directly to quick coupler
- Inject while using spot sprinklers or your favorite hose nozzle
- Fits 3/4" hoses
- 1" adapters available for 1" swivels and hoses.



- IRRA-PPQ-075** IN-LINE APPLICATOR
- IRRA-PPBG** BOWL BUNA GASKET
- IRRA-PPBK** BOWL W/ GASKET
- IRRA-PPB** BOWL ONLY (NO GASKET)
- IRRA-BA107FM** HOSE ADAPTER, 1" FHT TO 3/4" MHT

SUPERKEY

Fits All Brands & Has Common Tools



- Effortlessly turns electric valve-in-heads on and off, removes internal snap rings and performs many other sprinkler maintenance chores.
- Great for John Deere®/Signature® sprinklers too!

IRRA-SKTRB

Pricing is subject to change.

DYNAMIC WATER PRESSURE GAUGE



- This is the ideal tool for checking actual working water pressure versus static pressure
- There are many practical uses for this new specially designed gauge package
- Pressure range up to 160PSI.
- Measures both Dynamic and Static pressure
- Comes in 1 inch or 3/4 inch
- Solid brass construction

IRRA-HPG-075 3/4" FHT X 3/4" MHT

IRRA-HPG-100 1" FHT X 1" MHT

21 INCH IRRIGATION MARKING FLAGS (Bundle Of 100)



- IRRMF21YW** YELLOW
- IRRMF21BU** BLUE
- IRRMF21WH** WHITE
- IRRMF21RD** RED
- IRRMF21OR** ORANGE
- IRRMF21PK** PINK

FLAG SIZE 4" X 5" 21" TALL

SPECIALTY USE PRESSURE CHECKERS



- Nozzle discharge pressure gauges & adapters
- Use these liquid-filled 160 PSI gauge with 30" Flex hose and solid brass pitot tube, hose bib, or spray head and Schrader adapters to measure water pressure at discharge points.



- IRRA-PHG-160K** GAUGE AND 30" FLEX HOSE WITH PITOT TUBE
- IRRA-HCGPK** GAUGE AND PITOT TUBE
- IRRA-HCP** PITOT TUBE ONLY
- IRRA-SV-160K** GAUGE WITH SCHRADER VALVE ADAPTER
- IRRA-SHG-160K** GAUGE WITH SPRAY HEAD ADAPTER

CATCH CAN ULTRA Package Of 12



- Self standing - easily anchors into turf, even on slopes
- Measures sprinkler application in inches or centimeters
- Unique design allows for shorter duration test
- Made of durable polypropylene engineered plastic
- Can be stacked for easy storage and transport
- Each 12 Pack Kit (comes with instructions)

IRRCCUPK-12 12 PACK



AUDITMASTER IRRIGATION EFFICIENCY TESTING KIT

EXPERT Sprinkler Performance Testing PRO Kits

Increasing watering times to compensate for poorly performing sprinklers wastes a lot of water. Accurately measuring sprinkler application rates with Underhill® AuditMaster™ helps maximize water savings.



KIT INCLUDES:

- 36 CatchCan Ultras
- Pressure Checker with Gauge/Hose/Pitot Tube
- Pressure Checker with Gauge/Hose/Schrader Valve
- Pressure Checker with Spray Head Adapter
- Hose Bib Tap
- Stop Watch
- Anemometer Wind Gauge
- 100 Foot Measuring Tape
- 50 Marking Flags
- Wheeled Carry Case

IRRAUD-LT **COMPLETE KIT**

PLASTIC HIGH FLOW SHUT OFF



IRRA-BV77FM PLASTIC SHUT OFF
3/4" INLET

BRASS HIGH FLOW SHUT OFF



IRRCV075H BRASS SHUT OFF
3/4" INLET

HOSE REPAIR AND ADAPTER FITTINGS



- | | | |
|----|----------------------|---|
| 1 | IRRA-BA107FM | HOSE REDUCER - 1" FHT X 3/4" MHT |
| 2 | IRRA-BA107MF | HOSE REDUCER - 1" MHT X 3/4" FHT |
| 3 | IRRHPF8C | 3/4" MHT X 3/4" MPT (OR 1/2" FPT) |
| 4 | IRRSM1 | 1" HOSE MENDER |
| 4 | IRRSM34 | 3/4" HOSE MENDER |
| 5 | IRRHYZ-SO | ZINC HOSE WYE WITH SHUT-OFFS |
| 6 | IRR075C | 3/4" BRASS HOSE COUPLING SET |
| 6 | IRR100C | 1" BRASS HOSE COUPLING SET |
| 7 | IRRHPF7 | 3/4" HOSE SWIVEL - 3/4" FHT X 3/4" FHT |
| 8 | IRRHN075W-10 | HOSE WASHER, 3/4", PACK OF 10 |
| 8 | IRRHN100W-10 | HOSE WASHER, 1", PACK OF 10 |
| 9 | IRRHPF13 | 1/2" FPT X 3/4" FHT |
| 10 | IRRHPF12 | 3/4" FPT X 3/4" FHT |
| 11 | IRRA-QC075 | 3/4" QUICK CONNECT FOR 5/8" AND 3/4" HOSE CONNECTIONS (SET) |
| 12 | IRRA-BA10NXSH | 1" FPT X 1" MALE PIPE TO HOSE THREAD ADAPTER |
| 13 | IRRA-BN107MM | 1" MPT X 3/4" MALE GHT PIPE TO HOSE THREAD ADAPTER |

Pricing is subject to change.

ULTRAMAX TURBOSHIFT
Shifts from Light Fog to Full Stream



ULTRAMAX FULL THROTTLE
Maximum Flow Patterns



- The innovative TURBO SHIFT feature provides two distinct GPM ranges for added versatility. It's like having two nozzles in one.
- Start with the wider pattern for cooling and light watering at a low gallon - and then kick it into turbo for full flow when you dial it into a jet pattern.
- Both Full Throttle and Turbo Shift models All models offer multi-pattern spray: fog, jet stream, fan
- 1" and 3/4" Hose Inlet threads

- Delivers a steady, high flow fog, jet stream and fan patterns
- Virtually indestructible and leak proof
- 1" and 3/4" Hose Inlet threads

- IRRNG550-DFH-75** 3/4" HIGH GPM (12-43 GPM)
- IRRNG550-DFH-10** 1" HIGH GPM (12-43 GPM)
- IRRNG550DFSH-10** 1" SUPER HIGH FLOW (34-104 GPM)

- IRRNG500-SFH-75** 3/4" HIGH GPM (15-40 GPM)
- IRRNG500-SFH-10** 1" HIGH GPM (15-40 GPM)



MAGNUM ULTRAMAX ECONOMY PLUS SERIES
TurboShift Model



- IRRNG650-DFH-75** 3/4" HIGH GPM (12-43 GPM)
- IRRNG650-DFH-10** 1" HIGH GPM (12-43 GPM)

MAGNUM ULTRAMAX ECONOMY PLUS
Full Throttle Model



- IRRNG600-SFH-75** 3/4" HIGH GPM (15-40 GPM)
- IRRNG600-SFH-10** 1" HIGH GPM (15-40 GPM)

The same patterns, gallons and performance of the premium nozzles, but at a much lower cost because they are made of composite material instead of alloy.

PRECISION NOZZLE KITS Task Specific Nozzles



COOL PRO

Cool Turf Without Over-Watering



When you need a specific amount of water, for a specific task, the precision nozzles are your choice. Give the right nozzle to your employee to ensure they put the right amount of water down for their task. Choose a nozzle kit with brass shutoff or the nozzle only.

We've all been there, spending our summer afternoons in the brutal heat keeping Greens cool. We can't chage that, but we can give you a tool that will make the job easier. The cool pro was designed for the simple task to cool, but not over water.

- Rainbow (Yellow) - soft cone water pattern great for lightly watering Greens, seed beds, transplants or delicate landscapes (15 gpm)
- Rainmaker (Green) - cone pattern for spot watering Greens without over saturating and creating runoff (23 gpm)
- Cloudburst (blue) - cone pattern that's great for localized dry spots & is our nozzle of choice for pellet pro applicators (35 gpm)
- Cyclone (red) - when you just need a lot of water in a flat fan controlled pattern on fairways, roughs or infield skin (50 GPM)

- 25 foot pattern delivers long reach for quicker syringing
- At 70 psi, creates 25 foot fog while only using 4-6 gpm
- Durable metal design
- Choose the nozzle only or purchase with a convenient hand held shutoff

- IRRHN1500CV** RAINBOW
- IRRHN2300CV** RAINMAKER
- IRRHN4800CV** CLOUDBURST
- IRRHN5000CV** CYCLONE

- IRRHN0600** NOZZLE ONLY
- IRRHC075** NOZZLE & SHUTOFF
- IRRCV075L** SHUTOFF ONLY

INCLUDES NOZZLE, BRASS SHUT OFF & 1" ADAPTER

PRECISION NOZZLES ONLY

3/4" Size- Add Adapter For 1"

- IRRHN1500** RAINBOW (15 GPM)
- IRRHN2300** RAINMAKER (23 GPM)
- IRRHN4800** CLOUDBURST (35 GPM)
- IRRHN5000** CYCLONE (50 GPM)

CAN'T DECIDE & WANT THEM ALL? Nozzle Locker



Just need to have all the fire power right at your fingertips? Here's our solution, all of the best nozzles, in a secure, unbreakable case.

- Entire precision nozzle series
- Brass high flow valve
- Cool pro nozzle
- Ultramax turbo shift nozzle

- IRRHP-K3** 3/4"
- IRRHP-K5** 1"

MAGNATION TURFBOLT



All the same good stuff as the larger magnation units, just a smaller size. Not sure if Magnation is right for you? This is a great way to test it on your course and see the benefits yourself.

The Turfbolt is excellent for hoses, spigots and sprinklers, and can be used in pivot drops, seeders and fertigation. Available sizes include 3/4" or 1" sizes.

- IRRTB75** 3/4" HOSE THREAD
- IRRTB10** 1" PIPE THREAD

TURFBOLT BENEFITS MAY INCLUDE:

- Keeps sprayer parts, emitters and nozzles free of mineral build up
- Reduced water, energy and chemical requirements
- Solve hydrogen sulfide (rotten egg smell) issues
- Significantly reduced water hardness (CaMg)
- Solve calcium carbonate (CaCO3) problems
- Eliminate localized hydrophobic dry spots
- Reduce SAR's (Sodium adsorption ratio)
- Solve bicarbonate (HCO3) problems
- Increased dissolved oxygen (O2)
- Denser, safer and Greener turf
- Improved nutrient uptake

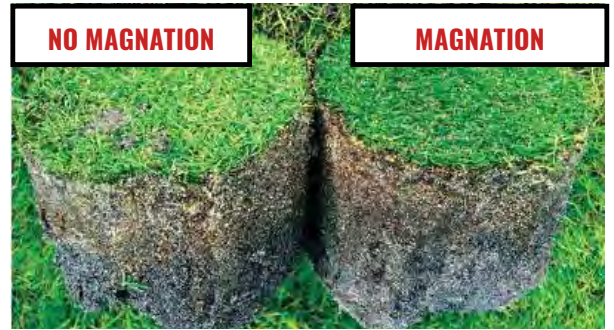

NEW PRODUCT!

MAGNUM STINGER NOZZLE
All Pressure Nozzle

- Superior, picture perfect patterns when used with low pressure or low flow rates
- All metal construction gives you high performance, low volume patterns when used in high pressure situations
- Ergonomic design fits comfortably in your hand



IRRNG400 3/4"

RAINPRO



IRRSHN-75 3/4" OR 1" INLET
Comes with 3/4" adapter

TWIST-EASE KINK ELIMINATOR
Irrigation Hose Swivel



IRRHSE-75 3/4" KINK ELIMINATOR
IRRHSE-100 1" KINK ELIMINATOR

BUCKNER GREENS SPRAY NOZZLE
Bronze - 1 Inch Inlet



IRRNZ022 1" HOSE THREAD

MAGNUM
3/4" Inlet Solid Metal



IRRNG450 3/4"

POWER BLAST SWEEPER NOZZLES

3/4" adjustable stream



IRRGNA-75

3/4" x 2"



IRRSN2-75

3/4" x 6"



IRRSN6-75

1" x 8"



IRRSN8-10

TRIGGER NOZZLE
3/4" Inlet



IRR60-12721

TOURNAMENT-READY PLUS PELLETS
With Actosol & Micro-Nutrients



16 PELLETS PER CASE
IRRUHTRPLPEL-16

TOURNAMENT-READY PELLETS



16 PELLETS PER CASE
IRRUHTRPEL-16

H2O MAXIMIZER® PELLETS



16 PELLETS PER CASE
IRRUHH2OPEL-16

TOURNAMENT READY WET-WELL PELLETS



- Uniform moisture management (doesn't bind in the thatch layer)
- Increases soil moisture without causing "spongy turf" problems
- Easily applied through pump station wet well to apply to the entire course during normal watering
- 2 pellet pack - 8lbs each

2 PELLETS PER CASE
IRRUHTRPEL-8



PELLET PRO APPLICATORS



IRRA-PPWA50K
PELLET PRO APPLICATOR W/ SHUT OFF & CLOUDBURST NOZZLE

IRRA-PPWASHNK
PELLET PRO APPLICATOR W/ SHUT OFF & RAINPRO NOZZLE

IRRA-PPBK
PELLET PRO REPLACEMENT BOWL & GASKET

PELLET PRO QUICK COUPLER MOUNT



- IRRA-PPQ-075 IN-LINE APPLICATOR
- IRRA-PPBG BOWL BUNA GASKET
- IRRA-PPBK BOWL W/ GASKET
- IRRA-PPB BOWL ONLY (NO GASKET)
- IRRA-BA107FM HOSE ADAPTER, 1" FHT TO 3/4" MHT
- IRRA-BA107MF HOSE ADAPTER, 1" MHT TO 3/4" FHT

LIQUIDPRO WETTING AGENT APPLICATOR GUN

IRRA-LPWWASHNK





PAR WEST PREMIUM MICRO SPRINKLER STARTER KIT

IRRMASKIT



- 100' of PVC tubing
- 10 bases with fittings and nozzles
- all fittings needed for 3 sets

All components are also sold separately below.

Our Micro Sprinkler Systems allow you to cost effectively soak a nagging hot spot without affecting golfers or causing run off.

INDIVIDUAL COMPONENTS

- IRRM5H50-100 TUBING (100 FT. ROLL)
- IRRM5H50-200 TUBING (200 FT. ROLL)
- IRRM5444 BASE ALONE
- IRRM520575 REPLACEMENT NOZZLE
- IRR050-0400-80 NOZZLE RISER - 4"
- IRR430-005 NOZZLES COUPLER
- IRRM5F64 FEMALE TUBE ADAPTER
- IRRM5AP110 SWIVEL ADAPTER
- IRRM5AP100 END CAP FOR BASE



IRRM5H50-100
IRRM5H50-200



IRRM520575



IRR0500-400-80



IRRM5444



IRRM5F64



IRRM5AP100



IRRM5AP110



IRR430-005-45



PRESSURE REGULATOR FOR MICRO SPRINKLER KITS
Control Application Rates & Prevent Blowouts

THIS PRESSURE REGULATOR IS THE PERFECT ADDITION TO OUR MICRO SPRINKLER KIT

- Keeps pressure consistent at 25 PSI
- 3/4 inch female hose thread x 3/4 inch male hose thread
- More accurate flow rates for flushing Greens
- Prevent blow outs by controlling pressure



IRR51388



SPOTSHOT

Low Volume Portable Sprinkler Kit



20 FT. RADIUS / 0.65 GPM (0.16 IN./HR.) 20 FT. RADIUS / 1.2 GPM (0.26 IN./HR.)

SpotShot™ is an expandable sprinkler system kit ideal for turf areas requiring low volume watering for extended periods. Connect the Starter Kit to a quick coupler (or golf sprinkler with the HoseTap and connect Add-On Kits for larger area needs.

- **Starter Kit includes** 20' of 1/2" flexible PVC tubing with connection fittings, pressure regulator, sprinkler base and low volume rotating sprinkler (20 ft. radius / 0.65 GPM - 0.16 in./hr.)At 70 psi, creates 25 foot fog while only using 4-6 gpm
- **Add-On Kit includes** 20' of 1/2" flexible PVC tubing with connection fittings, sprinkler base and low volume rotating sprinkler (20 ft. radius / 0.65 GPM - 0.16 in./hr.) Choose the nozzle only or purchase with a convenient hand held shutoff
- **Micro-Sprinkler Options:**
- RED - 20 ft. radius / 0.65 GPM (0.16 in./hr.)
- BLUE - 20 ft. radius / 1.2 GPM - (0.26 in./hr.)

IRRSS-SK	STARTER KIT - 20 FT. RADIUS / 0.65 GPM
IRRSS-AOK	ADD-ON KIT - 20 FT. RADIUS / 0.65 GPM
IRRSS-SK-26	STARTER KIT - 20 FT. RADIUS / 1.2 GPM
IRRSS-AOK-26	ADD-ON KIT - 20 FT. RADIUS / 1.2 GPM
IRRSS-S16	SPRINKLER 20 FT. RADIUS / 0.65 GPM
IRRSS-S26	SPRINKLER 20 FT. RADIUS / 1.2 GPM
IRRSS-SB	SPRINKLER BASE

ECONOMY PORTABLE SPRINKLER BASE

W/ 3/4" Hose Swivel Connection



IRRSBASS	COMPLETE W/ SPRINKLER ASSEMBLY
IRRSB75	BASE ONLY - 3/4"
IRRA-BA107MF	ADAPTER - 1" FHT X 3/4" MHT

SPRINKLER ASSEMBLY INCLUDES 4" ADJUSTABLE HEAD & NIPPLE

ROLLER PRO

Portable Sprinkler Base

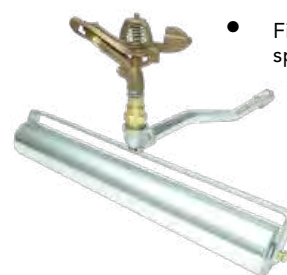

- Fits 3/4" X 1" hoses and sprinklers

IRRA-RP221	ROLLER BASE ONLY
IRRA-RPASS	BASE WITH SPRINKLER

IMPACT SPRINKLER IS A 3/4" FULL CIRCLE HEAD

IMPACT SPRINKLERS

Full Or Part Circle



IRRSI075F	3/4" FULL CIRCLE
IRRSI075P	3/4" PART CIRCLE
IRRSI100F	1" FULL CIRCLE
IRRSI100P	1" PART CIRCLE
IRRSI125F	1.25" FULL CIRCLE
IRRSI125P	1.25" PART CIRCLE



HUNTER PGP ROTOR

Adjustable Arc

- The industry standard, Best Selling Rotor Since 1981
- Arc setting: 40 to 360 degrees
- Through-the-top arc adjustment
- Quick check arc mechanism
- Water lubricated gear-drive
- Nozzle racks: red, blue, gray low angle

IRRHPGP-04	4" STANDARD
IRRHPGP-00	4" SHRUB ROTOR
IRRHPGP-04-CV	4" W/ CHECK VALVE
IRRHPGP-00-CV	4" SHRUB W/ CHECK VALVE

Case Discounts Available

Pricing is subject to change.

ECONOMY BRASS ELECTRIC VALVE
Globe Style



**BEST
\$
VALUE**

IRRAGV-125 1.25"
IRRAGV-150 1.5"

RAINBIRD BRASS ELECTRIC VALVE
Globe Style



IRRRB100EFBCP 1"
IRRRB150EFBCP 1.5"
IRRRB200EFBCP 2"

RAINBIRD PLASTIC VALVE
Globe Style



IRRRB100PEB 1"
IRRRB150PEB 1.5"
IRRRB200PEB 2"

HUNTER I-20 SERIES ROTOR
Plastic Body And Riser



- 4 inch, 6 inch or 12 inch models
- Plastic or stainless steel risers
- Radius of 17-46 feet
- Arc settings from 50 - 360 degrees
- 34 Nozzle choices
- 5 year warranty

IRRH20-04 4" PLASTIC
IRRH20-04-SS 4" STAINLESS
IRRH20-06 6" PLASTIC
IRRH20-06-SS 6" STAINLESS
IRRH20-12 12" PLASTIC

HUNTER I-25 SERIES ROTOR
Plastic Body And Riser



- 4 inch or 6 inch models
- Plastic or stainless steel risers
- Radius of 40-71 feet
- Arc settings from 50 - 360 degrees
- 12 Nozzle choices
- 5 year warranty

IRRH25-04 4" PLASTIC
IRRH25-06 6" PLASTIC

HUNTER I-40 SERIES ROTOR
Stainless Steel Riser



- Models stainless riser: 4", 6"
- Arc setting: 50 to 360 degrees
- Factory installed rubber cover
- Nozzle choices: 12
- Nozzle ranges I-40: #8 to #25
- Nozzle ranges I-40-ON: #15 to #28
- Through-the-top arc adjustment
- Quick check arc mechanism
- Water lubricated gear-drive
- Warranty period: 5 years

IRRH40-04-SS 4" STAINLESS
IRRH40-06-SS 6" STAINLESS

Case Discounts Available.

RAINBIRD 1800 SAM POP-UP BODY

Pressure Regulator & Check Valve



- 1800 Series pop-up spray head with Seal-A-Matic™ check valve
- Designed for use with all Rain Bird plastic spray head nozzles
- Traps water in lateral pipes in elevation changes of up to 14 feet
- Prevents drainage from spray heads at lower elevations
- Stops water waste
- Ends landscape damage due to flooding and/or erosion

6" **IRRRB1806SAM**

12" **IRRRB1812SAM**

RAINBIRD 1800 POP-UP BODY
Nozzle Not Included



- Co-molded wiper seal provides unmatched resistance to grit, pressure and the environment
- Precision controlled flush at pop-down clears debris from unit, assuring positive stem retraction in all soil types
- Two-piece ratchet mechanism allows easy nozzle pattern alignment and provides added durability
- Five-year trade warranty

6" **IRRRB1806**

12" **IRRRB1812**

RAINBIRD 1800 SERIES NOZZLES
Matched Precipitation Rate Nozzles

CALL FOR PRICING

IRRR-5Q	5 feet	QUARTER - 90 DEGREE
IRRRB-5H	5 feet	HALF - 180 DEGREE
IRRRB-5F	5 feet	FULL - 360 DEGREE
IRRRB-8Q	8 feet	QUARTER - 90 DEGREE
IRRRB-8H	8 feet	HALF - 180 DEGREE
IRRRB-8F	8 feet	FULL - 360 DEGREE
IRRRB-10Q	10 feet	QUARTER - 90 DEGREE
IRRRB-10H	10 feet	HALF - 180 DEGREE
IRRRB-10F	10 feet	FULL - 360 DEGREE
IRRRB-12Q	12 feet	QUARTER - 90 DEGREE
IRRRB-12H	12 feet	HALF - 180 DEGREE
IRRRB-12TQ	12 feet	THREE QUARTERS - 270 DEGREE
IRRRB-12F	12 feet	FULL - 360 DEGREE
IRRRB-15Q	15 feet	QUARTER - 90 DEGREE
IRRRB-15H	15 feet	HALF - 180 DEGREE
IRRRB-15TQ	15 feet	THREE QUARTERS - 270 DEGREE
IRRRB-15F	15 feet	FULL - 360 DEGREE
IRRRB-15EST	15 feet	END STRIP
IRRRB-15CST	15 feet	CENTER STRIP
IRRRB-15RCS	15 feet	RIGHT CORNER STRIP
IRRRB-15LCS	15 feet	LEFT CORNER STRIP
IRRRB-15SST	15 feet	SIDE STRIP

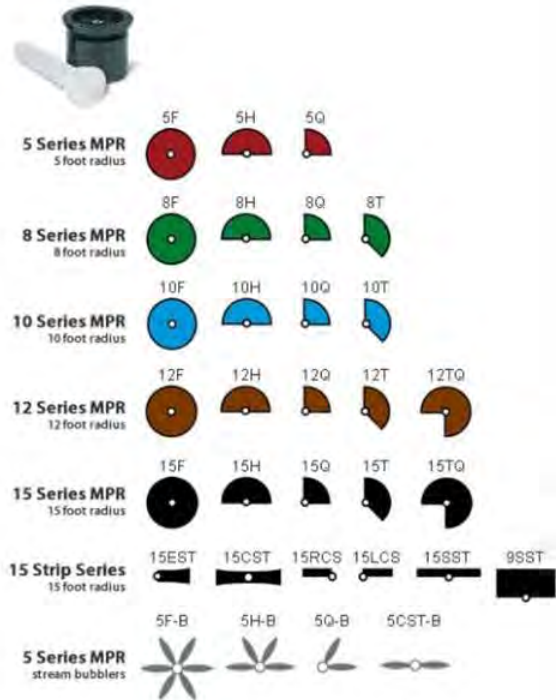

Pricing is subject to change.

TORO EMPTY SPRINKLER CASES

Reconditioned

- Empty sprinkler cases are reconditioned and come with all parts except for the internal rotor (conversion assembly)
- All cases are subject to availability
- Credit toward purchase given for returned old cases

IRRT102-1094	RECONDITIONED 1" CASE ASSEMBLY - NEW STYLE - ACME
IRRT102-1090	RECONDITIONED 1" CASE ASSEMBLY - NEW STYLE - NPT
IRRT89-8635	RECONDITIONED 1" CASE ASSEMBLY - OLD STYLE - ACME
IRRT35-9421	RECONDITIONED 1" CASE ASSEMBLY - OLD STYLE - NPT
IRRT89-8646	RECONDITIONED 1.5" CASE ASSEMBLY - OLD STYLE - ACME
IRRT3-3389	RECONDITIONED 1.5" CASE ASSEMBLY - OLD STYLE - NPT



TORO SPRINKLER PARTS

Reconditioned

All parts are subject to availability
All parts are reconditioned

IRRT89-1048	1" BOTTOM VALVE - OLD STYLE - SHORT PIN (\$8 OFF WITH EXCHANGE OF OLD VALVE)
IRRT102-4003	1.5" BOTTOM VALVE (\$8 OFF WITH EXCHANGE OF OLD VALVE)
IRRT102-5178	ADJUSTABLE PILOT VALVE W/ SOLENOID
IRRT89-009	NON-ADJUSTABLE PILOT VALVE W/ SOLENOID
IRRT9-2623	PILOT BLOCK TUBE (PACK OF 12)
IRROR-100	O RING - 1" (363-4102)
IRROR-150	O RING - 1.5" (363-4103)
IRRT89-1385	UPPER SNAP RING - 1" (12 PACK)
IRRT35-6119	UPPER SNAP RING - 1.5" (12 PACK)



RAINBIRD SPRINKLER PARTS

Reconditioned

- All parts are subject to availability
- All parts are reconditioned



IRRRB211468	500/700 SERIES BOTTOM VALVE (\$8 OFF WITH EXCHANGE OF OLD VALVE)
IRRRB211266	900 SERIES BOTTOM VALVE (\$8 OFF WITH EXCHANGE OF OLD VALVE)
IRROR-100RB	O RING - 1" (211242) 500 & 700 SERIES
IRROR-150RB	O RING - 1.5" (212383) 900 SERIES
IRRRB211921	SNAP COVER - 500 & 700 SERIES (12 PACK)
IRRRB211934	SNAP COVER - 900 SERIES (12 PACK)

**AFTERMARKET REPLACEMENT
BOTTOM (FOOT) VALVES**

Fit Toro Or Rainbird Golf Sprinklers

- Brand new aftermarket replacement bottom valves are completely compatible with OEM Toro or Rainbird valves
- No cores to exchange
- Readily available



IRRT10024	1" TORO - NEW STYLE - LONG PIN
IRRT10048	1" TORO - OLD STYLE - SHORT PIN
IRRT15003	1.5" TORO
IRRRB112007	RAINBIRD EAGLE 500-750 SERIES



PROFILE SOLID METAL IRRIGATION NOZZLES

730 SERIES FULL CIRCLE FRONT & REAR NOZZLES

PART #	NOZZLE COLOR RANGE / SPREADER	TORO NOZZLE #
IRRT730-3313	BROWN 33 / GRAY 13	33
IRRT730-3413	BLUE 34 / GRAY 13	34
IRRT730-3515	VIOLET 35 / RED 15	---
IRRT730-3515L	GREEN 35 / RED 15*	35
IRRT730-3615	RED 36 / RED 15*	36



760 AND 860 SERIES PART CIRCLE REAR NOZZLES

PART #	NOZZLE COLOR MIDRANGE / CLOSE-IN
IRRT760-GY	760 - GRAY / YELLOW
IRRT860-GY	860 - GRAY / YELLOW



834, DT SERIES FULL CIRCLE REAR NOZZLES

PART #	NOZZLE COLOR MIDRANGE / CLOSE-IN
IRRT834-GY	834 - GRAY / YELLOW
IRRT100-GY	DT34 - GRAY / YELLOW



835 SERIES FULL CIRCLE REAR NOZZLES

PART #	NOZZLE COLOR MIDRANGE / CLOSE-IN
IRRT835S-WP	WHITE / PLUG



670 SERIES FULL CIRCLE REAR NOZZLES

PART #	NOZZLE COLOR MIDRANGE / CLOSE-IN
IRRT670-BY	BLACK / YELLOW



690 SERIES FULL CIRCLE REAR NOZZLES

PART #	NOZZLE COLOR SPREADER
IRRT690-G	GRAY



780, 854S, DT SERIES FULL/PART CIRCLE REAR NOZZLES

PART #	NOZZLE COLOR MIDRANGE / CLOSE-IN
IRRT780-BY	780 - BLACK / YELLOW
IRRT854-BY	854S - BLACK / YELLOW
IRRT150-BY	DT54/55 - BLACK / YELLOW



855S SERIES FULL CIRCLE REAR NOZZLES

PART #	NOZZLE COLOR SPREADER
IRRT855S-PP	PINK / PLUG



750 SERIES FULL CIRCLE FRONT & REAR NOZZLES

PART #	NOZZLE COLOR RANGE / SPREADER
IRRT750-5617	RED 56 / LAVENDER 17
IRRT750-5717	GRAY 57 / LAVENDER 17



EAGLE 700 SERIES FULL CIRCLE NOZZLES

PART #	NOZZLE COLOR MIDRANGE / CLOSE-IN
IRRR70028-RG	28 - BLUE / GRAY
IRRR70032-RG	32 - RED / GRAY



RAINBIRD HEADS

51 SERIES FULL CIRCLE FRONT & REAR NOZZLES

PART #	NOZZLE COLOR RANGE / SPREADER	RAINBIRD NOZZLE #
IRRR51-1411.5	WHITE 14 / GRAY 11.5	14 / 11.5
IRRR51-1611.5	BLUE 16 / GRAY 11.5	16 / 11.5
IRRR51-1811.5	YELLOW 18 / GRAY 11.5	18 / 11.5
IRRR51-2011.5	RED 20 / GRAY 11.5	20 / 11.5
IRRR51-2213	GREEN 22 / BLACK 13	22 / 13
IRRR51-2413	BLACK 24 / BLACK 13	24 / 13



900 SERIES FULL CIRCLE REAR NOZZLE

PART #	NOZZLE COLOR CLOSE-IN
IRRR900-M	MAROON



Pricing is subject to change.

CARSON RECTANGULAR VALVE BOX

14" X 19" Green With Lid



IRR1419-12-4B CARSON 14" X 19" VALVE BOX W/ LID
IRRNDS317C GREEN LID ONLY

NDS RECTANGULAR VALVE BOX

14" X 19" Green With Lid



IRRNDS14X19 NDS 14" X 19" VALVE BOX W/ LID
IRRNDS317C GREEN LID ONLY

All Other Sizes Available

CARSON TRUSTEE VALVE BOX

6" With Green Lid



IRRC708-9-4 6" ROUND VALVE BOX W/ GREEN LID
IRRC910-10-4B 10" ROUND VALVE BOX W/ GREEN LID

NDS ROUND VALVE BOX

With Green Lid



IRRNDS6R 6" ROUND VALVE BOX W/ GREEN LID
IRRNDS10R 10" ROUND VALVE BOX W GREEN LID

VERSALID

Fits Any 6"-7" Round Valve Box



IRRVL-6 6-INCH GREEN LID
IRRVL-10 10-INCH GREEN LID
IRRVL-6P 6-INCH PURPLE LID
IRRVL-10P 10-INCH PURPLE LID
IRRVL-6T 6-INCH TAN LID
IRRVL-10T 10-INCH TAN LID

NIBCO BRONZE GATE VALVES



- Threaded w/ cross handle, 200 psi working

IRRNT113-1 1"
IRRNT113-1.25 1 1/4"
IRRNT113-1.5 1 1/2"
IRRNT113-2 2"
IRRNT113-2.5 2 1/2"

BRASS GATE VALVES

- Threaded w/ cross handle, 200 psi working pressure

IRRBGV-050X 1/2"
IRRBGV-075X 3/4"
IRRBGV-100X 1"
IRRBGV-125X 1 1/4"
IRRBGV-150X 1 1/2"
IRRBGV-200X 2"
IRRBGV-250X 2 1/2"
IRRBGV-300X 3"
IRRBGV-400X 4"



WESTLAKE JOINT CONFIGURATOR

Create Your Part Number

G	STEP	STEP	STEP	STEP	STEP	STEP
	1	2	3	4	4	4

HOW TO ORDER YOUR SWING JOINT

Step 1 - Choose Body Diameter by Number Below

- 1 1"
- 2 1.25"
- 3 1.5"

step 2 - Specify an Inlet by Number Below

- 1 Socket
- 2 Spigot (short)
- 3 Male Thread (Mipt)
- 4 Male Acme
- 5 Metric Spigot
- 6 Male Bspt
- 7 Long Spigot (4" Long)
- 8 Female Bspt
- 9 Reducing Female Bspt
- h Spigot Saddle Connection (increases from 1" spigot to swing joint size)
- m Main Line (reduces from 1.5" acme to swing joint size)
- p Tap't Saddle Connection (reduces from 1.5" acme to swing joint size)



step 3 - Specify an Outlet by Number

- 1 Socket
- 2 mipt (available in 1", 1.25" & 1.5")
- 3 Enlarging Mipt (available in 1", 1.25" & 1.5")
- 4 Mipt Special (available in 1" and 1.25")
- 5 Thread Bspt (available in 1", 1.25" & 1.5")
- 6 Enlarging Bspt (available in 1.5")
- 7 Reducing Mipt (available in 1")
- 8 Increasing Acme (available in 1.5")
- 9 Increasing Bspt (available in 1.25")
- 0 Acme (available in 1", 1.25" & 1.5")
- a Acme special (available in 1.25")
- c Reducing Acme (available in 1")

step 4 - Specify Lay Length

- 1__ kits - specify size
- 208 8" unitized standard size
- 212 12" unitized standard size
- 218 18" unitized standard size
- 310 10" fabricated size
- 324 24" fabricated size
- 330 30" fabricated size
- 408 8" unitized triple top size
- 412 12" unitized triple top size
- 418 18" unitized triple top size
- 510 10" fabricated triple top size
- 524 24" fabricated triple top size
- 530 30" fabricated triple top size

Pricing is subject to change.

Par west offers the highest quality of Westlake Fittings!
 Sizes offered are 1/2", 3/4", 1", 1 1/4", 1 1/2", 2, and 4" in
 schedule 40 and 80 families.

Due to new tariff taxes, please call for a quote with current
 pricing as prices are subject to change.

WESTLAKE FEMALE ADAPTER
 SCH. 40



WESTLAKE MALE ADAPTER
 SCH. 40



WESTLAKE THREADED CAP
 SCH. 40



THREADED REDUCER BUSHING
 SCH. 40



WESTLAKE SLIP REDUCER BUSHING
 SCH. 40



WESTLAKE SLIP CAP
 SCH. 40



THREADED COUPLING
 SCH. 80



THREADED COUPLING
 SCH. 40



WESTLAKE SLIP X FEMALE NPT 90
 SCH. 40



WESTLAKE SLIP X FEMALE THREADED TEE
 SCH. 40



WESTLAKE FEMALE THREADED ELBOW
 SCH. 40



WESTLAKE FEMALE THREADED ELBOW
 SCH. 80



WESTLAKE 90 STREET ELL ADAPTER MARLEX



SLIP X SLIP X FPT REDUCING TEE
 SCH. 40



SLIP X SLIP X SLIP REDUCING TEE
 SCH. 40



WESTLAKE 90 STREET ELL ADAPTER
 SCH. 40



Par west offers the highest quality of Westlake Fittings!
 Sizes offered are 1/2", 3/4", 1", 1 1/4", 1 1/2", 2, and 4" in
 schedule 40 and 80 families.

Due to new tariff taxes, please call for a quote with current
 pricing as prices are subject to change.

PVC UNION CONNECTIONS
 SCH. 40 OR SCH. 80



SLIP FIX REPAIR COUPLING
 SCH. 40



COMPRESSION REPAIR COUPLING
LASCOTITE



WESTLAKE SLIP COUPLING
 SCH. 40



WESTLAKE SLIP ELBOW
 SCH. 40



WESTLAKE 45 DEGREE
SLIP ELBOW
 SCH. 40



WESTLAKE SLIP TEE
 SCH. 40



CHRISTY'S RED HOT GLUE



- QUART **IRRCRHG-Q**
- GALLON **IRRCRHG-G**
- DAUBER **IRRCQD**
- EMPTY QUART
CONTAINER **IRRCEC-Q**

CHRISTY'S PURPLE PRIMER



- QUART **IRRCPP-Q**
- GALLON **IRRCPP-G**
- DAUBER **IRRCQD**

PREMIUM TEFLON TAPE



- 1/2" **SHPTT1/2**
- 3/4" **SHPTT3/4**
- 1" **SHPTT1**

Pricing is subject to change.

**SCHEDULE 80 NIPPLES
CALL FOR PRICING**



LENGTH	1/2" PART #	3/4" PART #	1" PART #	2" PART #
CLOSE	IRR050-0100-80	IRR075-0100-80	IRR100-0100-80	IRR200-0100-80
2"	IRR050-0200-80	IRR075-0200-80	IRR100-0200-80	N/A
3"	IRR050-0300-80	IRR075-0300-80	IRR100-0300-80	IRR200-0300-80
4"	IRR050-0400-80	IRR075-0400-80	IRR100-0400-80	IRR200-0400-80
5"	IRR050-0500-80	IRR075-0500-80	IRR100-0500-80	IRR200-0500-80
6"	IRR050-0600-80	IRR075-0600-80	IRR100-0600-80	IRR200-0600-80
8"	IRR050-0800-80	IRR075-0800-80	IRR100-0800-80	IRR200-0800-80
10"	IRR050-1000-80	IRR075-1000-80	IRR100-1000-80	IRR200-1000-80
12"	IRR050-1200-80	IRR075-1200-80	IRR100-1200-80	IRR200-1200-80
18"	IRR050-1800-80	IRR075-1800-80	IRR100-1800-80	IRR200-1800-80
24"	IRR050-2400-80	IRR075-2400-80	IRR100-2400-80	IRR200-2400-80
36"	IRR050-3600-80	IRR075-3600-80	IRR100-3600-80	IRR200-3600-80

MAINLINE REPAIR PARTS

Order Online At Parwest.com



- We carry a full selection of mainline repair parts from Leemco, Smith Blair And Romac
- There are too many options to list, so call us and we will find you the exact part you need



SMITH BLAIR 313 SADDLE
Double Bale

- The wide saddle body provides stability on the pipe
- The gasket is fully bonded to the cavity to hold it in place
- NPT threaded outlets available in sizes 1" thru 4"
- A closed lug on one side, combined with the bale, acts as a hinge for easier installation



SMITH BLAIR 317 SADDLE
Double Bale Stainless

- The wide saddle body provides stability on the pipe
- Designed with PVC and other soft or brittle pipe in mind
- The gasket fully bonds to the cavity to hold it in place
- NPT threaded outlets available in sizes 1" thru 4"
- Wide bands spread the load over larger area to prevent damage to the pipe when tightening the straps



SMITH BLAIR 461 STANDARD LENGTH QUANTUM COUPLINGS

226 SINGLE BAND FULL CIRCLE® REPAIR CLAMPS



14 GAUGE DIRECT BURIAL IRRIGATION WIRE 500 Foot Spool



- IRRWY14-500 YELLOW
- IRRBW14-500 BLACK
- IRRWR14-500 RED
- IRRWW14-500 WHITE
- IRRWBL14-500 BLUE
- IRRWO14-500 ORANGE
- IRRW14-500 PURPLE

WIRING TOOLS Channellock



- CHA447 DIAGONAL WIRE CUTTER
- CHA959 WIRE STRIPPER & CRIMPER
- CHA908 WIRE STRIPPER & CRIMPER

DIRECT BURIAL SPLICE KITS Waterproof Connectors



- IRRDDBRY SPLICE KIT
- IRRDDBRY-100 BAG OF 100



3M RED/YELLOW WIRE NUTS Bag of 100 Wire Nuts



SHPWN-YR

IRRIGATION TESTER KIT



- Troubleshoot irrigation systems
- Activate and cycle solenoids
- Test solenoids for continuity
- Send tone to identify wires
- Measure clock voltage
- Easy-to-understand LEDs

IRR24BK

WIRE LOCATER/TRACER



- Traces the path and determines the depth of wires
- Lightweight receiver provides audible and visual indications of signal strength
- Transmitter output and receiver sensitivity are fully adjustable for maximum accuracy
- Molded carrying case included

IRRWL501

PULSE FAULT LOCATER



- Identifies the exact location of even the smallest breaks in insulation
- Multiple faults on a single wire can be identified indicating the need to replace instead of repair
- Molded carrying case included

IRRPE2003-G

Pricing is subject to change.

RAINBIRD PAR+ ES BOARD EXCHANGES & REPAIRS

Reconditioned Parts



1

1	IRRRB635711	PAR+ ES	TIMING MECHANISM
2	IRRRB635513-00	PAR+ ES	POWER INTERCONNECT - 48 STATION
2	IRRRB635513-01	PAR+ ES	POWER INTERCONNECT - 72 STATION
3	IRRRB635121	PAR+ ES	TERMINAL STRIP BOARD - STA 1-24
3	IRRRB635124	PAR+ ES	TERMINAL STRIP BOARD - STA 25-48
3	IRRRB635560	PAR+ ES	TERMINAL STRIP BOARD - STA 49-72
4	IRRRB634677-01	PAR+ ES / PAR+ / MSC+	OUTPUT STATION MODULE - NO SWITCHES
4	IRRRB634677-02	PAR+ ES / PAR+ / MSC+	OUTPUT STATION MODULE - WITH SWITCHES
5	IRRRB633280	PAR+ ES / PAR+ / MSC+	LINK INTERFACE BOARD



2



3



4



5



6

RAINBIRD PAR+ BOARD EXCHANGES & REPAIRS

Reconditioned Parts



1

1	IRRRB633224	PAR+	TIMING MECHANISM
2	IRRRB633513-02	PAR+	POWER INTERCONNECT
3	IRRRB633608	PAR+ / MSC+	TERMINAL STRIP BOARD - STA 1-24
3	IRRRB633610	PAR+ / MSC+	TERMINAL STRIP BOARD - STA 25-48
4	IRRRB634677-01	PAR+ ES / PAR+ / MSC+	OUTPUT STATION MODULE - NO SWITCHES
4	IRRRB634677-02	PAR+ ES / PAR+ / MSC+	OUTPUT STATION MODULE - W/ SWITCHES
5	IRRRB633653	PAR+ / MSC+	RELAY OUTPUT MODULE
6	IRRRB633280	PAR+ ES / PAR+ / MSC+	LINK INTERFACE BOARD



2



3



4



5



6

PAR WEST BOARD EXCHANGE



CONVENIENCE - QUALITY - SIMPLICITY

- Order the boards you need
- We will ship you reconditioned boards with a return label in the box
- Put your old board back in the box and send it back

We Carry a Full Line of Controller Parts

- Cables
- Power supplies
- Pedestals
- Radios
- Antennas
- Check our website for more options

PAR WEST BOARD EXCHANGE



- Order the boards you need
- We will ship you reconditioned boards with a return label in the box
- Put your old board back in the box and send it back

SIMPLE AND CONVENIENT

QUALITY YOU CAN COUNT ON

All Boards Go Through The Following Process

- Every board receives a complete tear down and thorough cleaning
- All broken and damaged parts are identified and replaced
- Every board gets tested and approved before going back into the field
- We stand behind every board with a 1 year warranty

RAINBIRD MSC BOARD EXCHANGES & REPAIRS

Reconditioned Parts



1



2



3



4



5

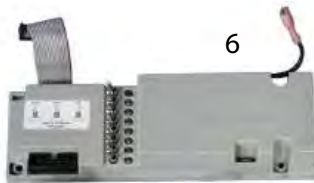

6

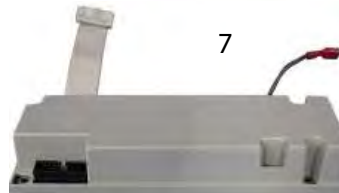

7



8

1	IRRRB634955	MSC+	TIMING MECHANISM
2	IRRRB631388-01	MSC 16	TIMING MECHANISM
2	IRRRB631388-02	MSC 24	TIMING MECHANISM
3	IRRRB635513-02	MSC+	POWER INTERCONNECT
4	IRRRB633608	MSC+ / PAR+	TERMINAL STRIP BOARD - STA 1-24
4	IRRRB633610	MSC+ / PAR +	TERMINAL STRIP BOARD - STA 25-48
5	IRRRB631550	MSC 16 & 24	TERMINAL STRIP BOARD
6	IRRRB634677-01	PAR+ ES / PAR+ / MSC+	OUTPUT STATION MODULE - NO SWITCHES
6	IRRRB634677-02	PAR+ ES / PAR+ / MSC+	OUTPUT STATION MODULE - WITH SWITCHES
7	IRRRB633653	PAR+ ES / PAR+ / MSC+	RELAY OUTPUT MODULE
8	IRRRB633280	PAR+ ES / PAR+ / MSC+	LINK INTERFACE BOARD

RAINBIRD RADIO MODEM BOARD EXCHANGE & REPAIR



1	IRRRB634433	PAR+ / PAR / MSC / MSC+ / PAR+ ES	RADIO MODEM
---	--------------------	-----------------------------------	-------------

Pricing is subject to change.



1



2

TORO VP BOARD EXCHANGES & REPAIRS

Reconditioned Parts

- 1 **IRRT102-3497** VP TIMING MECHANISM
- 2 **IRRT102-2782** VP DISTRIBUTION BOARD
- 3 **IRRT102-0104-01** VP MODEM BOARD - SINGLE CONNECTOR
- 3 **IRRT102-0104-02** VP MODEM BOARD - THREE CONNECTORS
- 4 **IRRT102-3015** VP PUMP COMMON BOARD
- 5 **IRRT102-2549** VP OUTPUT STATION BOARD
- 6 **IRRT102-0640** VP SWITCH AND SURGE BOARD



3



4



5



6



1



2

TORO LTC 1.0 - 2.0 BOARD EXCHANGES & REPAIRS

Reconditioned Parts

- 1 **IRRT91-2337** LTC 1.0 TIMING MECHANISM - NO TERMINAL BLOCK IN PEDESTAL
- 1 **IRRT91-0545** LTC 1.0 TIMING MECHANISM - TERMINAL BLOCK COMMONLY IN PEDESTAL
- 2 **IRRT89-7169** LTC 2.0 TIMING MECHANISM
- 3 **IRRT91-0777** LTC 1.0 MODEM BOARD
- 3 **IRRT89-7852** LTC 2.0 MODEM BOARD
- 4 **IRRT91-1303** LTC 1.0 8 STATION BOARD W/ SURGE PROTECTION
- 5 **IRRT89-7170** LTC 2.0 STATION OUTPUT BOARD
- 6 **IRRT91-1305** LTC 1.0 PUMP COMMON BOARD
- 7 **IRRT89-7171** LTC 2.0 PUMP COMMON BOARD
- 8 **IRRT91-1307** LTC 1.0 / LTC 2.0 SURGE PROTECTION - COMMUNICATION
- 9 **IRRT89-6977** LTC 2.0 DISTRIBUTION BOARD



3



4



6



8



5



7



9

TORO LTC PLUS BOARD EXCHANGES & REPAIRS

Reconditioned Parts



1

- | | | | |
|---|---------------------|------|---|
| 1 | IRRT102-0238 | LTC+ | TIMING MECHANISM |
| 2 | IRRT102-0681 | LTC+ | 8 STATION OUTPUT BOARD |
| 3 | IRRT89-7852 | LTC+ | MODEM BOARD |
| 4 | IRRT102-0612 | LTC+ | DISTRIBUTION BOARD |
| 5 | IRRT102-8078 | LTC+ | SWITCH & SURGE BOARD - NO SWITCHES OR SURGE |
| 5 | IRRT102-8079 | LTC+ | SWITCH & SURGE BOARD - SWITCHES ONLY |
| 5 | IRRT102-8080 | LTC+ | SWITCH & SURGE BOARD - SWITCHES AND SURGE |



2



3

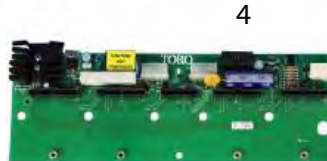

4



5



6

TORO NETWORK 8000 BOARD EXCHANGES & REPAIRS

Reconditioned Parts



1

- | | | | |
|---|---------------------|--------------|----------------------------|
| 1 | IRRT91-1280 | NETWORK 8000 | TIMING MECHANISM |
| 2 | IRRT35-6166 | NETWORK 8000 | POWER SUPPLY |
| 3 | IRRT35-8646 | NETWORK 8000 | MODEM BOARD |
| 4 | IRRT35-8000 | NETWORK 8000 | TRIAC BOARD - SINGLE BOARD |
| 5 | IRRT89-8100 | NETWORK 8000 | TRIAC BOARD - TWO TIER |
| 6 | IRRT35-6326 | NETWORK 8000 | PUMP / CURRENT MONITOR |
| 7 | IRRT35-8502 | NETWORK 8000 | VALVE VOLTAGE MONITOR |
| 8 | IRRT35-8652 | NETWORK 8000 | DISTRIBUTION BOARD |
| 9 | IRRT118-1524 | NETWORK 8000 | COMMUNICATION SURGE BOARD |



2



3



4



5



6



7



8



9

**PAR WEST
BOARD EXCHANGE**



CONVENIENCE - QUALITY - SIMPLICITY

- Order the boards you need
- We will ship you reconditioned boards with a return label in the box
- Put your old board back in the box and send it back

WE CARRY MORE OPTIONS

- Osmac board and parts
- Cables
- Power supplies
- See website for more options

Pricing is subject to change.

SAFETY NET



- The 6-½ ft. x 6 ft. (1.98 m x 1.83 m) net provides ample protection for employees doing work in the line of fire.
- Collapsible frame has aluminum uprights with fiberglass upper and lower cross pieces and heavy-duty step-in stakes that secure the uprights.
- The net is high-strength polypropylene with high-visibility safety yellow borders.

PAR1100

ISOLATION VALVE KEYS & PROBES

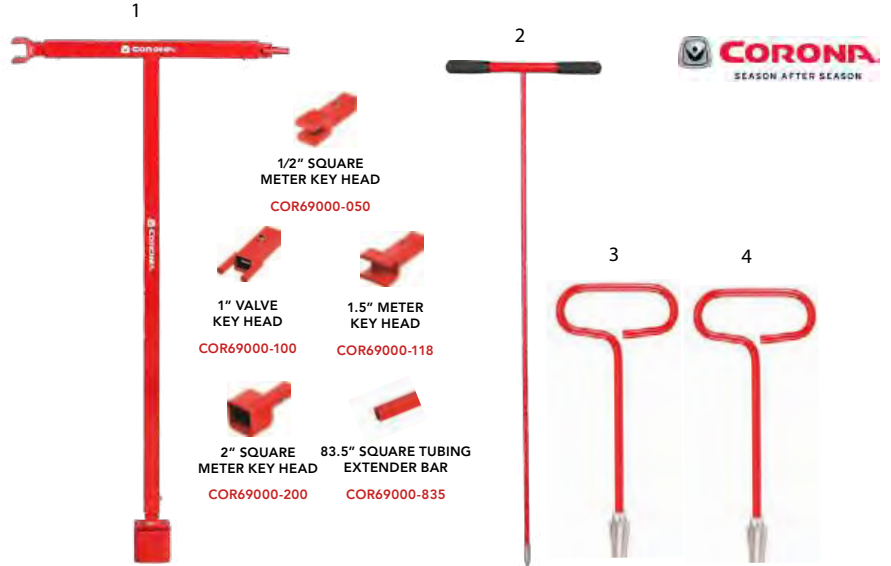

- 1 **CORUT69000** MULTI USE KEY - MAINLINE, METER AND SPRINKLER VALVE
- 2 **CORUT64050** 48" SOIL PROBE - LOCATE VALVE BOXES OR SPRINKLERS
- 3 **CORUT65001** 1 INCH AND 1.25 INCH EZ-OUT
- 4 **CORUT65002** 1/2 INCH AND 3/4 INCH EZ-OUT

MICHIGAN AXE

Solid-Core Fiberglass Handle 36" Hickory Handle w/ Poly Guard



CORAX70020

PICK MATTOCK

36" Hickory Handle w/ Poly Guard



CORPM41000

8 LB. SLEDGEHAMMER

32" Solid-Core Fiberglass Handle



CORST70021

12 LB. SLEDGEHAMMER

34" Solid-Core Fiberglass Handle



CORST70024

GROUND ZERO II

High Pressure Drain Cleaning



Convenient folding design makes the GZ II easy to use, carry, and store, with arms spanning 54". Built from high-quality steel, it's virtually indestructible. Perfect for irrigation installs or resetting heads and boxes to prevent mower damage and improve efficiency.



FOLDING DESIGN

- Indispensable tool for leveling and holding irrigation heads and valve boxes
- Ideal device for golf course, sports field or other grounds area irrigation projects
- Convenient folding design makes it easy to use, carry and store
- Use for initial installation or resetting
- 54" (137 cm) steel arms are virtually indestructible

PAR525540

154 IRRIGATION & WATERING

2 IN 1 INNER-OUTER PVC DEBURRING TOOL Pipe Deburring Reamer Plumbing Tool



IRRDT \$89.75

ADJUSTABLE WRENCH Channellock



- CHA804 4" WRENCH
- CHA806W 6" WRENCH
- CHA808W 8" WRENCH
- CHA812W 12" WRENCH

6 PIECE SCREWDRIVER SET Channellock



CHASD-6H

12" HIGH TENSION HACKSAW



SEY41442 HACKSAW

36" CABLE SAW



KEN41448

TONGUE AND GROOVE PLIERS Channellock



- CHA430 10"
- CHA440 12"
- CHA460 16"

STEEL PIPE WRENCH



- SEY41602 18" LENGTH
- SEY41604 24" LENGTH

2" PROFESSIONAL PVC PIPE CUTTER



SEY41436

PVC PIPE CUTTER



Pricing is subject to change.

HEAD TRIMMER ATTACHMENTS FOR STRING TRIMMERS

- We have every type of trimmer attachment to make edging sprinklers, valve boxes and yardage markers a breeze
- Easily mount to all major brands of trimmers
- Save time and money by speeding up the process of trimming heads
- We have optional mounting kits to provide all of the hardware needed to mount a trimmer head

PLASTIC HEAD TRIMMERS



- One-piece nylon unit with four vertical blades.
- 24 vanes create a vacuum, pulling the grass into the blades and distributing it away from the sprinkler head.

- SHPPH6** 6" HEAD
- SHPPH6.5** 6.5" HEAD
- SHPPH7.5** 7.5" HEAD
- SHPPH10** 10" HEAD

METAL IRRIGATION HEAD TRIMMERS



- Super heavy-duty steel construction
- Blades for all size heads, valve boxes, yardage markers available
- 1" or 20 mm arbor holes fit nearly every trimmer

- SHPTH7** 7" HEAD
- SHPTH7.5** 7.5" HEAD
- SHPTH8** 8" HEAD
- SHPTH8.5** 8.5" HEAD
- SHPTH10** 10" HEAD

HEAD TRIMMER MOUNTING KITS



- We always try to make things easier for our customers and here we did it again
- Mounting kits for major trimmer brands that will mount any blade to your unit

- SHPTH-ECH** ECHO
- SHPTH-SHN** SHINDAIWA

IRRIGATION HEAD TRIMMER



- Trim thick grass - even removes roots - around irrigation heads or yardage markers.
- One handle works with a wide range of head sizes.
- Plated-steel construction.

- STD29900** HANDLE ONLY
- STD29905** 5" HEAD
- STD29906** 6" HEAD
- STD29907** 7" HEAD
- STD29908** 8" HEAD
- STD29909** 9" HEAD
- STD29910** 10" HEAD

UNDERHILL TURBO TRIM Pro Ratchet Series

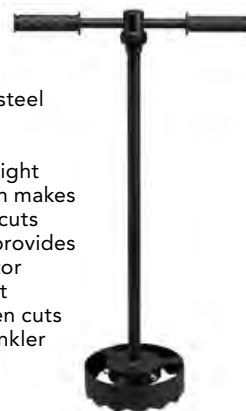

- Durable materials, super heavy-duty steel construction
- Easy to use
- Reversible left or right ratcheting function makes for faster, cleaner cuts
- Wide "T" handle provides "centered" operator position to prevent wobbling or uneven cuts
- Fits most golf sprinkler series

- IRRTTRT-100** HANDLE
- IRRTTRC-007** 7" HEAD
- IRRTTRC-008** 8" HEAD
- IRRTTRC-011** 11" HEAD

ACCUFORM ACCUTRIM

NEW PRODUCT!



- Power irrigation head trimmer – attaches to any cordless drill (drill not included)
- Multiple cutting head sizes for universal fit on Toro, Rainbird and Hunter irrigation heads
- Built-in spacer controls cutting depth to prevent solenoid damage
- Heavy-duty steel construction

- PAR13280** ACCUTRIM DRIVE TOOL
- PAR13280-1** 7.75" HEAD
- PAR13280-2** 7.25" HEAD
- PAR13280-3** 6.9" HEAD
- PAR13280-4** 5.0" HEAD





POWER GULP BATTERY-POWERED PUMP

NEW PRODUCT!

Power Gulp delivers an impressive 11 GPM, even in the murkiest waters. No more struggling with clogs or weak flow – MudGuard technology filters out debris, ensuring smooth operation where other pumps fail.



Underhill Battery & Charger

- 4 Amp Hr. 18 Volt battery
- Slides into stock plate on Power Gulp
- Battery only or Battery and Charger



Interchangeable battery plates allow pump to operate with most 18V-20 slide-style batteries from Milwaukee, Makita, DeWALT, and Bosch (pump comes standard with Bosch® plate)

- Versatility at its finest: Use interchangeable battery plates (sold separately) compatible with major brands like Milwaukee, DeWalt, Makita, or Bosch.
- Adaptable discharge options: Choose Gulp tubing, 3/4" hose, or 1" hose with included adapters.
- Unmatched endurance: Enjoy up to 60 minutes of continuous pumping per charge.
- Unrivaled performance in dirty water: Where others struggle, Power Gulp excels.

3 Discharge Hose Options To Choose From:
3/4" GHT garden hose,
1" NPSH water hose, &
1 5/8" Gulp Tubing



- IRRA-PG-18V** POWER GULP UNIT W/O BATTERY
- IRR-PG-APBO** BOSCH ADAPTER PLATE
- IRR-PG-APDE** DEWALT ADAPTER PLATE
- IRR-PG-APMA** MAKITA ADAPTER PLATE
- IRR-PG-APMI** MILWAUKEE ADAPTER PLATE
- IRR-PG-BAT** UNDERHILL 18V X 4.0A BATTERY
- IRR-PG-BATCH** UNDERHILL 18V X 4.0A BATTERY + CHARGER

Power Gulp Pump Recommended Uses



Battery not included with purchase!



GULP SYRINGE

RA-G125-C



GULP ULTRAMAX PLUS

21" PUMP W/ 36" DISCHARGE HOSE

IRRA-G1236-C



BIG GULP ULTRAMAX HAND PUMP

36" PUMP W/ 72" DISCHARGE HOSE

IRRA-G3672-CK

BIG GULP ULTRAMAX MUD GUARD

- Comes standard with ultramax pumps
- Can be purchased separately as well
- Built in filter minimizes clogging and makes pumping easier
- Easy on and off for cleaning



IRRA-GMG MUD GUARD ONLY



Pricing is subject to change.



1" WATER PUMP



3" SEMI-TRASH PUMP



2" SEMI-TRASH PUMP



3" FULL PUMP

WATER AND TRASH PUMPS
Gas Powered Predator Engine

- Water or trash pumps available
- Trash pumps can handle light debris without damage to pump
- Choose size based on capacity needs
- Hoses and fittings available
- California compliant
- **All pump options use Predator branded engines**

PUMP DESCRIPTION GUIDE

TYPE	GOLF COURSE USE
WATER PUMP	Clean water transfer or irrigation tasks.
SEMI-TRASH PUMP	Puddles or debris in fairways or bunkers.
FULL PUMP	Floodwater and heavily debris-filled areas.

PART #	PUMP TYPE	INLET/OUTLET SIZE	DISCHARGE MAX HEAD	SUCTION MAX HEAD	DISCHARGE GPM	ENGINE CC
1. IRRWP1	WATER	1 INCH	95 FEET	19 FEET	35 GPM	79 CC
2. IRRSTP2	SEMI-TRASH	2 INCH	91 FEET	26 FEET	158 GPM	212 CC
3. IRRSTP3	SEMI-TRASH	3 INCH	85 FEET	26 FEET	290 GPM	212 CC
4. IRRFTP3	FULL	3 INCH	88 FEET	23 FEET	385 GPM	301 CC

SUCTION AND DISCHARGE HOSES
For All Water And Trash Pumps

COMPLETE HOSE KITS

Hose pump kits include 65' blue PVC discharge hose, 20' green PVC suction hose, steel round hole suction strainer & cam and groove adapters for hose and pump

- IRHK1** 1" COMPLETE HOSE KIT
- IRHK2** 2" COMPLETE HOSE KIT
- IRHK3** 3" COMPLETE HOSE KIT

SUCTION HOSE

- IRRS120G** 1" X 20' GREEN SUCTION W/ ALUMINUM/BRASS THREADED ENDS
- IRRS220G** 2" X 20' GREEN SUCTION W/ ALUMINUM/BRASS THREADED ENDS
- IRRS320G** 3" X 20' GREEN SUCTION W/ ALUMINUM/BRASS THREADED ENDS

DISCHARGE HOSE -25'

- IRRDH125R** 1" X 25' PVC DISCHARGE W/ ALUMINUM/BRASS THREADED ENDS
- IRRDH225R** 2" X 25' PVC DISCHARGE W/ ALUMINUM/BRASS THREADED ENDS
- IRRDH325R** 3" X 25' PVC DISCHARGE W/ ALUMINUM/BRASS THREADED ENDS

DISCHARGE HOSE -05'

- IRRDH225R** 2" X 50' PVC DISCHARGE W/ ALUMINUM/BRASS THREADED ENDS
- IRRDH325R** 3" X 50' PVC DISCHARGE W/ ALUMINUM/BRASS THREADED ENDS



COMPLETE HOSE KIT



SUCTION HOSE



DISCHARGE HOSE

PORTA PUMP

Clear Water Quickly And Easily



- Golf Bunkers- Clear standing water in minutes.
- Irrigation Breaks/Leaks: Quickly empty flooded irrigation head blow outs or line breaks.
- Cart Paths/ Walking Trails/ Bike Path - quickly clear and standing water from low lying areas in the cart path.
- Clogged Drains: Quickly clear away water from clogged drain areas so that you can identify and quickly fix the problem.
- Water Pipe Breaks:- clear the water quickly while other workers identify and fix the problem.
- SPORTS FIELDS: Quickly clear standing water from low lying areas around bases, home plate or high traffic areas.

PPH-35 COMPLETE KIT



12 VOLT ELECTRIC BUNKER PUMP

- Includes 12 volt submersible pump with 8 feet of cord and alligator clip extensions available
- High Volume Complete Kit pumps 78 GPM and includes 25 feet X 2 inch discharge hose
- Kit is ready to go - hook to utility vehicle or sand pro battery and get nuisance water out of bunkers quickly



ACUSP02

HIGH VOLUME PUMP ONLY - 4700 GPM

IRRDH2-25B

DISCHARGE HOSE, 2 INCH X 25 FT. LONG, LAYFLAT W/ CLAMP

IRRDH2-50B

DISCHARGE HOSE, 2 INCH X 50 FT. LONG, LAYFLAT W/ CLAMP

TLTSHU-WH

WIRE HARNESS, 10 FT. LONG W/ CONNECTION PLUG & ALLIGATOR CLIPS

IRRBP-HV

HIGH VOLUME COMPLETE KIT W/ 2 INCH X 25 FT. DISCHARGE HOSE

PORTA PUMP JUNIOR

Converts Weedeater Into Pump



PPH-SQ-KIT COMPLETE KIT - SQUARE SHAFT

PPH-SP-KIT COMPLETE KIT - SPLINED SHAFT

PPH-JR-SQ PORTA PUMP ONLY - SQUARE SHAFT

The PortaPump Junior is a commercial grade pump that will fit on to any brand of string trimmer or brushcutter.

- Up to 30 GPM (depending on engine size)
- Minimum engine size required is 1 HP
- Self-priming
- 4 lbs. and 1.25" discharge
- Porta Pump Junior comes in square or splined shaft models. Echo & Stihl trimmers require square shaft. Shindaiwa requires splined shaft
- Two part numbers available - complete kit includes discharge hose and options wire mesh screen to keep out smaller particles (great for bunkers)

Pricing is subject to change.



VFX SERIES AERATION FOUNTAINS

1/2HP, 3/4HP, 1HP, 2HP, & 5HP

DRAMATICALLY IMPROVE YOUR WATER QUALITY!

- The best of both beautiful eye-catching displays and aeration
- 120V and 208-240V, single and three phase options
- One-piece float blends with water's surface and is easy to install
- Bottom screen helps prevent clogging
- Manage from shore with human-rated, GFCI-protected control panel



HP	DISPLAY		CORD	50 FT	100 FT	150 FT	200 FT	250 FT	300 FT	400 FT	500 FT
	H (FT)	W (FT)									
120V, SINGLE PHASE PACKAGES											
1/2	5	15	PART #	KAS2400VFX050	KAS2400VFX100	KAS2400VFX150	KAS2400VFX200	--	--	--	--
3/4	5.5	21	PART #	KAS3400VFX050	KAS3400VFX100	KAS3400VFX150	KAS3400VFX200	--	--	--	--
1	8	26	PART #	KAS4400VFX050	KAS4400VFX100	KAS4400VFX150	KAS4400VFX200	--	--	--	--

208-240V, SINGLE PHASE PACKAGES											
3/4	5.5	21	PART #	KAS3400HVFX050	KAS3400HVFX100	KAS3400HVFX150	KAS3400HVFX200	KAS3400HVFX250	KAS3400HVFX300	KAS3400HVFX400	KAS3400HVFX500
1	8	26	PART #	KAS4400HVFX050	KAS4400HVFX100	KAS4400HVFX150	KAS4400HVFX200	KAS4400HVFX250	KAS4400HVFX300	KAS4400HVFX400	KAS4400HVFX500

208-240V, SINGLE PHASE PACKAGES											
2	8	32	PART #	KAS8400VFX050	KAS8400VFX100	KAS8400VFX150	KAS8400VFX200	KAS8400VFX250	KAS8400VFX300	KAS8400VFX400	KAS8400VFX500
5	9	34	PART #	--	KAS5.1VFX100	KAS5.1VFX150	KAS5.1VFX200	KAS5.1VFX250	KAS5.1VFX300	KAS5.1VFX400	KAS5.1VFX500

208-240V, THREE PHASE PACKAGES											
2	8	32	PART #	KAS2.3VFX050	KAS2.3VFX100	KAS2.3VFX150	KAS2.3VFX200	KAS2.3VFX250	KAS2.3VFX300	KAS2.3VFX400	KAS2.3VFX500
5	9	34	PART #	--	KAS5.3VFX100	KAS5.3VFX150	KAS5.3VFX200	KAS5.3VFX250	KAS5.3VFX300	KAS5.3VFX400	KAS5.3VFX500

1/2HP, 3/4HP, & 1HP Product Notes:

*1/2HP can operate in 15 in. of water. 3/4HP can operate in 17.5 in. of water. 1HP can operate in 19 in. of water.

1. Prices in bold have quick disconnect installed on power cords.
2. 1/2, 3/4, and 1HP, 120V, single phase units include C-25 control panel.
3. 3/4 and 1HP, 208-240V, single phase units include C-85 control panel.
4. Solar-powered option available. Contact us for details.

2HP & 5HP Product Notes:

*2HP can operate in 20 in. of water. 5HP can operate in 26 in. of water. ** Extended warranty available on 2HP and 5HP units.

1. Prices in bold have quick disconnect installed on power cords.
2. 2HP, single phase units include C-85 control panel. 5HP, single phase units include C-95 control panel.
3. 2 and 5HP, three phase units include CF-3235 control panel.

4. Three phase units are constructed with a durable stainless steel motor top for reliable performance in all environments.
5. Mesh lining (included) around bottom screen further helps prevent clogging.
6. 460-480V, three phase option available for special order in approved locations only.
7. Solar-powered option available for 2HP, three phase units. Contact us for details.

LARGE POND FOUNTAINS



- 3 - 7.5 HP
- 240 volt models single or triple phase
- Interchangeable nozzles give you 7 pattern options
- Up to 28 feet high and 50 foot diameter spray patterns
- 2 year warranty

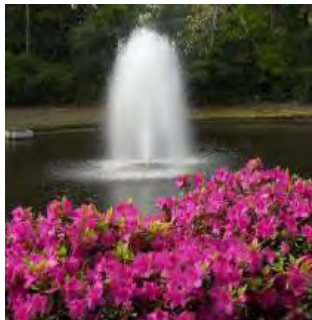

Kasco[®]



PART #	HP	PHASE	CORD LENGTH
KAS3.1JF050	3	1	50
KAS3.1JF100	3	1	100
KAS3.1JF150	3	1	150
KAS3.1JF200	3	1	200
KAS3.1JF250	3	1	250
KAS3.1JF300	3	1	300
KAS3.1JF400	3	1	400
KAS3.3JF050	3	3	50
KAS3.3JF100	3	3	100
KAS3.3JF150	3	3	150
KAS3.3JF200	3	3	200
KAS3.3JF250	3	3	250
KAS3.3JF300	3	3	300
KAS3.3JF400	3	3	400
KAS5.1JF100	5	1	100
KAS5.1JF150	5	1	150
KAS5.1JF200	5	1	200
KAS5.1JF250	5	1	250
KAS5.3JF100	5	3	100
KAS5.3JF150	5	3	150
KAS5.3JF200	5	3	200
KAS5.3JF250	5	3	250
KAS5.3JF300	5	3	300
KAS5.3JF400	5	3	400
KAS7.3JF100	7.5	3	100
KAS7.3JF150	7.5	3	150
KAS7.3JF200	7.5	3	200
KAS7.3JF250	7.5	3	250
KAS7.3JF300	7.5	3	300
KAS7.3JF400	7.5	3	400

Pricing is subject to change.



AQUATICLEAR Clog-Resistant Circulator



IRRIGATION PUMP PROTECTION=GREENER TURF!

- 120V and 208-240V, single phase options
- Unit only, Horizontal Float, and Universal Mount options available
- Universal Mounts include the Simple Swivel bracket.
- Shallow Water Install Kit available.
- Manage from shore with optional human-rated, GFCI-protected control panel
- Can be used to protect irrigation pumps from clogging.
- Filterizes for fresher, cleaner water for your greens.



HP	VOLT (V)	MODEL	CORD LENGTH									
			25 FT	50 FT	75 FT	100 FT	150 FT	200 FT	250 FT	300 FT	400 FT	500 FT
UNIT ONLY PACKAGES - "C" (NO MOUNT)												
1/2	120	KAS2400C_	25	50	--	100	150	200	--	--	--	--
3/4	120	KAS3400C_	25	50	--	100	150	200	--	--	--	--
3/4	208-240	KAS3400HC_	--	50	--	100	150	200	250	300	400	500
1	120	KAS4400C_	--	50	75	100	150	200	--	--	--	--
1	208-240	KAS4400HC_	--	50	--	100	150	200	250	300	400	500
HORIZONTAL FLOAT PACKAGES - "CFM"												
1/2	120	KAS2400CFM_	25	50	--	100	150	200	--	--	--	--
3/4	120	KAS3400CFM_	25	50	--	100	150	200	--	--	--	--
3/4	208-240	KAS3400HCFM_	--	50	--	100	150	200	--	300	400	500
1	120	KAS4400CFM_	--	50	75	100	150	200	--	--	--	--
1	208-240	KAS4400HCFM_	--	50	--	100	150	200	250	300	400	500
UNIVERSAL MOUNT PACKAGES - "CDM" (CUSTOMER MUST SUPPLY PIPE)												
1/2	120	KAS2400CDM_	25	50	--	100	150	200	--	--	--	--
3/4	120	KAS3400CDM_	25	50	--	100	150	200	--	--	--	--
3/4	208-240	KAS3400HCDM_	--	50	--	100	150	200	250	300	400	500
1	120	KAS4400CDM_	--	50	75	100	150	200	--	--	--	--
1	208-240	KAS4400HCDM_	--	50	--	100	150	200	250	300	400	500

Product Notes:

1. Prices in bold have quick disconnect installed on power cords.
2. Part # is the model combined with cord length (ex. KAS3400CDM150).
3. If AquatiClear is installed less than 1.5 ft. below the surface, a Shallow Water Install Kit is recommended.



LIGHTING KITS

Add to Any Kasco Fountain



3400 JF SERIES FOUNTAINS



4400 JF SERIES FOUNTAINS



Enjoy your Kasco fountain or surface aerator into the evening with these LED composite light kits. Designed to create a vibrant color display, these one-piece, composite fixtures feature ultrasonic welded lens, making them the most durable on the market. Each kit includes waterproof caps allowing customers to leave the main power cord in the water when fixtures are pulled for scheduled maintenance or winter storage. Available for fountains and surface aerators.

- Displays white and includes red, green, blue and amber lenses with lens caps
- Offered as 3 fixture, 4 fixture (non-Kasco units), 6 fixture kits
- Cord lengths up to 500 ft.
- Runs on 120VAC 60Hz power
- Each 11 watt fixture is rated at 910 lumens
- 2 year warranty

The 3400JF model is great for medium size ponds and when multiple fountain patterns are desired.

- 3/4 HP
- Available in 120 volt or 240 volt models
- The 5 fountain patterns range from 7' in height to 20' in diameter with 5 multiple fountain patterns
- Freedom to adjust the aerating fountain to fit your pond
- Adds oxygen and improves your pond or lake aeration.
- 3400JF includes C-25 control box
- 3400HJF includes C-85 control box
- 2 year warranty

The 4400JF model is great for medium size ponds and when multiple fountain patterns are desired. The 5 fountain patterns range from 10' in height to 27' in diameter. With 5 multiple fountain patterns, you have the freedom to adjust the aerating fountain to fit your pond, weather conditions, and your tastes. Adds oxygen and improving your pond or lake aeration.

- 1 HP
- available in 120 volt or 240 volt models
- Easy installation
- Low long-term operation costs
- Perfect for any size pond or lake
- Includes C-25 control box
- 4400HJF includes C-85 control box.
- 2 year warranty

120 VOLT JF SERIES

PART #	LIGHTS	CORD LENGTH
LED3C11-050	3	50
LED3C11-100	3	100
LED3C11-150	3	150
LED3C11-200	3	200
LED3C11-250	3	250
LED3C11-300	3	300
LED3C11-400	3	400
LED6C11-050	6	50
LED6C11-100	6	100
LED6C11-150	6	150
LED6C11-200	6	200
LED6C11-250	6	250
LED6C11-300	6	300
LED6C11-400	6	400

PART #	CORD LENGTH
KAS3400JF050	50
KAS3400JF100	100
KAS3400JF150	150
KAS3400JF200	200

120 VOLT JF SERIES

PART #	CORD LENGTH
KAS4400JF050	50
KAS4400JF100	100
KAS4400JF150	150
KAS4400JF200	200

240 VOLT HJF SERIES

PART #	CORD LENGTH
KAS3400HJF050	50
KAS3400HJF100	100
KAS3400HJF150	150
KAS3400HJF200	200
KAS3400HJF250	250
KAS3400HJF300	300

240 VOLT HJF SERIES

PART #	CORD LENGTH
KAS4400HJF050	50
KAS4400HJF100	100
KAS4400HJF150	150
KAS4400HJF200	200
KAS4400HJF250	250
KAS4400HJF300	300
KAS4400HJF400	400

Pricing is subject to change.



ROBUST-AIRE DIFFUSED AERATION

System 1

- 1 diffuser assembly
- 100 ft. 3/8 in. tubing
- 1 KM-60 compressor

PART #	VOLT	BASE TYPE
KASRA1-NC	120	NO CABINET
KASRAH1-NC	240	NO CABINET
KASRA1-PM	120	POST MOUNT CABINET
KASRAH1-PM	240	POST MOUNT CABINET
KASRA1	120	LARGE BASE MOUNT CABINET
KASRAH1	240	LARGE BASE MOUNT CABINET

Kasco's Robust-Aire Diffused Aeration Systems improve water quality in deep ponds. Air is injected into the bottom allowing the water to be thoroughly mixed. Independent 3rd party testing proves this design to be 44% more efficient than others on the market.

- Available with 1-6 diffuser heads
- Minimal surface disturbance
- Easy to install, use and maintain
- No electricity in the water



System 2

- 2 diffuser assemblies
- 200 ft. 3/8 in. tubing
- 1 KM-60 compressor

PART #	VOLT	BASE TYPE
KASRA2-NC	120	NO CABINET
KASRAH2-NC	240	NO CABINET
KASRA1-PM	120	POST MOUNT CABINET
KASRAH2-PM	240	POST MOUNT CABINET
KASRA2	120	LARGE BASE MOUNT CABINET
KASRAH2	240	LARGE BASE MOUNT CABINET



LARGE BASE MOUNT CABINET

POST MOUNT CABINET

System 3

- 3 diffuser assemblies
- 300 ft. 3/8 in. tubing
- 1 KM-120 compressor

PART #	VOLT	BASE TYPE
KASRA3-NC	120	NO CABINET
KASRAH3-NC	240	NO CABINET
KASRA3-PM	120	POST MOUNT CABINET
KASRAH3-PM	240	POST MOUNT CABINET
KASRA3	120	LARGE BASE MOUNT CABINET
KASRAH3	240	LARGE BASE MOUNT CABINET

System 5

- 5 diffuser assemblies
- 500 ft. 3/8 in. tubing
- 1 KM-60, 1 KM-120 compressor

PART #	VOLT	BASE TYPE
KASRA5	120	LARGE BASE MOUNT CABINET
KASRAH5	240	LARGE BASE MOUNT CABINET

System 4

- 4 diffuser assemblies
- 400 ft. 3/8 in. tubing
- 2 KM-60 compressors

PART #	VOLT	BASE TYPE
KASRA4	120	LARGE BASE MOUNT CABINET
KASRAH4	240	LARGE BASE MOUNT CABINET

System 6

- 6 diffuser assemblies
- 600 ft. 3/8 in. tubing
- 2 KM-120 compressors

PART #	VOLT	BASE TYPE
KASRA6	120	LARGE BASE MOUNT CABINET
KASRAH6	240	LARGE BASE MOUNT CABINET



POND PROBIOTICS Beneficial Bacteria



Kasco's Pond Probiotics are a safe, non-chemical approach to water quality management. Chosen by pond professionals since 1991, Pond Probiotics are used to produce a healthy, balanced eco-system with its highly concentrated, unique blend of naturally occurring bacteria and enzymes that quickly eliminates sludge and odors.

- Just toss in the water, let it go to work
- Apply in water 55 degrees or higher
- Safe for people, pets and fish



	DESCRIPTION	TREATMENT AREA	REAPPLICATION
KASMZ8	8 OZ. WS BAG	1/2 ACRE-FT.	EVERY 3 WEEKS
KASMZ8C	CASE OF 40 X 8 OZ. WS BAGS	UP TO 20 ACRE-FT.	EVERY 3 WEEKS
KASMZ25	25 LB. BULK BAG IN PAIL, NO WS BAGS	UP TO 20 ACRE-FT.	EVERY 3 WEEKS
KASMZMP7	MUCK PUCKS; 7 LB. PAIL WITH 266 PUCKS	UP TO 10 FT. PER PUCK	EVERY 3 WEEKS
KASMZMB5	MUCK BLOCK; 6 LB. BLOCK	UP TO 6 ACRE-FEET	EVERY 30 DAYS

AQUATIC WEED REMOVAL RAKES



Floating rake used to remove surface weeds and algae. Weed eradicator used for submerged weeds.

- TLT86036** FLOATING RAKE W/11' HANDLE & 50' THROW ROPE - 36" WIDE.
- TLT87028** WEED ERADICATOR

FAT LASER - HAND HELD UNIT Green Laser to Deter Geese

- Green laser technology
- Larger dot for easier application
- 12x stronger than other green laser units
- 200 Yard effective radius
- Safe for people & pets



TLTGD-H

GEESE DETERRENTS

GANDER DISBANDER - FLOATING UNIT

Floats in Lake to Deter Geese



- TLTGD-F** FLOATING W/ STEADY LASER
- TLTGD-FR** FLOATING W/ ROTATING LASER

GANDER DISBANDER - LAND BASED UNIT

Mount on Any Hazard Stake

- Green laser technology comes in two laser styles - rotating beam and 360 degree steady beam
- 12x stronger than other geese deterrents
- 200 Yard effective radius
- Weatherproof enclosure
- Safe for people & pets
- Solar powered
- Designed for use on open level areas
- Land unit comes mounted on 18" stake of any color
- Floating unit comes with a floating ring - just add an anchor

- TLTGD-L** LAND BASED W/ STEADY LASER
- TLTGD-LR** LAND BASED W/ ROTATING LASER



Pricing is subject to change.

GOPHER HAWK

The Ultimate Gopher & Mole Trap

- Spring loaded trap kills gophers or moles
- Requires no digging for installation or removal
- Yellow indicator tells you when trap has been triggered
- Saves money on labor
- Kit includes one trap, probe & wedge



TLTGH-SET TRAP KIT

TLTGH-TRP TRAP ONLY



BURROW RX

Smoke Out Burrowing Pests



- Direct targeting of rodents within the burrow system.
- No secondary toxicity concerns for scavengers and predators.
- Seldom requires handling of animals after treatment, which reduces the risk of disease and parasite transmittance to humans.
- Highly efficacious.
- Designated as a pest control device by the EPA.

GXCU205 BURROW RX MACHINE

GXOILPTC SMOKE SOLUTION (CASE OF 12 PINTS)

COYOTE REPLICA



- An effective, humane, chemical-free deterrent against geese, ducks, rabbits, skunks, and rodents!
- Features true-to-life markings, a furry tail, and a predatory posture for maximum effectiveness.
- Moves in even the slightest breeze.

TLTCOYOTE

THE GOOSINATOR



The Goosinator is a remote-controlled, space-aged design specifically made to chase geese off of your property. Comes with everything you need to chase off geese including remote, batteries & charger. Visit our website for more information and videos.

- Travels on grass, water, sand or snow
- High speed and easy to maneuver makes it highly effective at harassing geese or coots

GSN001

MACABEE GOPHER TRAPS



The Macabee Gopher Trap is the most effective means of gopher control. It has been copied, but never equaled in quality. Each trap is inspected, set and adjusted to ensure operational perfection. The same expert design used since 1900 shows that Macabee is, indeed, the "Old Reliable."

- Requires no bait
- Safer, more effective than gases or poisons
- Lasts for an unlimited number of kills

TLTMGT CASE OF 24 TRAPS

FIELDSCOUT TDR 150
Handheld Precision



- Improved measurement of Soil Moisture (Volumetric Water Content)
- Measures EC (Electrical Conductivity)
- Measures Turf Surface Temperature
- Improved Backlit Display
- Integrated Bluetooth
- Internal GPS

TLT6445 TDR 150

TDR 350 - MOST POPULAR
Moisture, EC & Temp In One Unit



- Improved measurement of Soil Moisture (Volumetric Water Content)
- Measures EC (Electrical Conductivity)
- Measures Turf Surface Temperature
- Improved Backlit Display
- Integrated Bluetooth
- Internal GPS

TLT6435 TDR350

TDR 250 ECONOMY
MOISTURE METER
Perfect for the Crew



- Displays VWC% (with running average)
- Operates in TDR 300 mode
- Soil measurements in less than a second
- Internal data logging up to 124,000 measurements
- USB port to download data log to a flash drive

TLT6250 TDR250

TDR RODS
Rods Sold in Sets of 2



- TLT6428FS4 1.5" RODS
- TLT6429FS4 3" RODS
- TLT6431FS4 4.8" RODS
- TLT6432FS4 8" RODS

FIELDSCOUT TDR ROD SPACER

Measures 0.5" or 1.0" shallow depths when used with 1.5" rods.



- Easy to use: attach and detach from Spectrum TDR 350/250/150 .
- Push the spacer onto the sensor block such that the desired length of rod is exposed.

TLT64355SP

FIELDSCOUT APP

App Subscription Through Par West!

FieldScout TDR meters can be used with the FieldScout Mobile App!

- Handsfree data collection
- The FieldScout Basic app allows you to take measurements in grid format
- Purchase a SpecConnect Pro subscription to take freeform measurements and see geo-referenced data points overlaid on your property
- Color coded data points to represent a scale of moisture, EC, surface temperature or turf firmness
- Map sprinkler heads, holes, pin locations and more
- Automatic wireless upload to SpecConnect for further analysis from your personal web portal



TDR in FREEFORM mode in a field of row crops. Pin colors can be changed to suit your preference.



TDR soil moisture data plots on a golf course using both the FREEFORM and GRID mode.

Views data in SpecConnect for more detailed informaton and reportng.

SPECCONNECT FIELDSCOUT SUBSCRIPTION PLANS

- TLT3035A 1 YEAR SUSCRPTION - 1-3 DEVICES
- TLT3035B 1 YEAR SUSCRPTION - 4-7 DEVICES
- TLT3035C 1 YEAR SUSCRPTION- 8+ DEVICES

FIELDSCOUT

Direct Soil EC Meter

- TLT2266FS EC METER W/ 8" PROBE AND CASE
- TLT2266FSTP EC METER W/ 24" T PROBE
- TLT2266PROBE REPLACEMENT 8" PROBE
- TLT2225FSP REPLACEMENT 24" PROBE
- TLT2251 CONDUCTIVITY STANDARD



**AMES INSTRUMENTS
HAND HELD INFRARED THERMOMETER**

12:1 Infrared Laser



- Excellent readability indoor and outdoors
- -50°C~550°C (-58°F~1022°F) Temp Range
- Backlit display
- High visibility laser targeting
- Designed for industrial, automotive, electrical and HVAC use ONLY.

TLT2956

SPOTON® TURF MOISTURE METER

Ultra High Frequency Measuring Circuit



NEW PRODUCT!

- Quick and accurate soil moisture, EC (salinity), and temperature readings in a compact and durable design.
- Continuous readings for quick moisture testing (no button pressing required)
- Measures soil moisture, salinity (EC), and soil surface temperature (°F or °C)
- Includes both 2.4" and 1.5" probe rods

TLT39240

**SPOTON® TURF MOISTURE METER
REPLACEMENT RODS**

1.5' & 2.4" Options



- Rubber mounted rods resist bending in dry or rocky soil
- Set of replacement rods comes in two replacement sizes

TLT40310 1.5" RODS

TLT40470 2.4" RODS

**SPOTON® DIGITAL SOIL
COMPACTION METER**



- 30in (76cm)
- 0 to 825 PSI (0 to 5690 kPa)
- Meets ASABE S313.3 Soil Compaction Standard
- Automatically displays maximum compaction value when probe is extracted from the soil
- Stainless steel shaft with depth marking every 4in (10cm)
- Internal GPS

TLT29360

MACROSCOPE

Portable Monocular Microscopes



- 20X is a fixed magnification monocular unit that provides 20X magnification and is ideal for insect identification in turfgrass environments. 20X offers a 5/16 (0.8 mm) field of view.
- 40X is ideal for disease diagnosis on turfgrass plants. 40X offers a 3/16 inch (0.4 mm) field of view.

TLTMACR20-2-C 20X MAGNIFICATION

TLTMACR40-2-C 40X MAGNIFICATION

SOILSTIK PH METER

Checks PH In Soil Or Water



TLT2105
SOILSTIK PH METER

TLT2106
REPLACEMENT SENSOR

SPRINKLER RAIN GAUGE COMBO



- 2-piece set
- Can use on fence, ground spike, or wall mount
 - Can gauge up to 5 feet

IRRRG

**TRUE FIRM
FIRMNESS METER**

With Bluetooth



TLT6490S

Based on technology developed by the USGA, the fieldscout trufirm offers a quick, easy, and affordable method to measure the firmness of turf and bunker sands.



TURF SPY

Stress Detection Glasses

Based on technology from NASA, turf spy glasses will help you see stress 2-10 days before it appears to the naked eye.

IRRNG655-01



NEW PRODUCT!

18" EASY REACH SOIL SAMPLER

With Ball Mark Repair Tool

- 18" length and pulls a 7/16" core – perfect for greens
- Ergonomic and comfortable handle contains a flip out ball mark tool that allows you to fix the hole from pulling the plug

IRRTSP-SS18



PROFILE SAMPLER

- Quickly pull a clean root zone sample.
- Check roots in fine turf areas.
- Steel construction, zinc-plated, case-hardened blade.
- 8"H x 4"W x 3/4"D samples.



STD29400



ACCUFORM SOIL PROFILE SAMPLER

- Hinge design for easy profile viewing.
- Tapered design prevents blades from separating
- Our Profile Sampler gives you an undisturbed soil profile 6 in. (15 cm) deep, 3 in. (8 cm) wide and 1/2 in. (1 cm) thick
- Hinge allows you to easily view the root zone and thatch clearly, with no bolts or screws to get in the way
- The innovative design not only keeps the blades from separating when inserted into the turf, but also makes it easier to replace the sample after viewing
- 25-1/2 in. (65 cm) Tall

PAR1130



COMPACT SOIL PROBE



ROUND SOIL PROFILE SAMPLER

Adjustable depth gauge allows soil sampler to double as 2" plunger repair.

- Designed for use on well watered golf greens
- Open side barrel for easy inspection of soil structure
- Tee handle and hand grips for ease of use
- Hardened steel blade

IRRTSP-SS

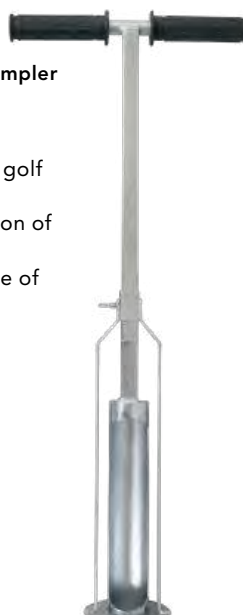

Designed for small core soil samples, fast simple and accurate.

- Triple window tine for quick and easy viewing of soil strata near the turf surface
- Lightweight stainless steel construction
- Plug size: 3/4" x 9 3/4"
- Removable "T" handle with convenient metal storage container

IRRTSP-HS

SOIL PROBES

- All of our soil probes are made of high quality stainless steel
- 3 sizes to choose from for any application

PART NUMBER	PLUG DIAMETER	LENGTH	
1. IRRTSP-12	1 IN	12X12 IN	NO
2. TLTSP-716	7/16 IN	18 IN	NO
3. TLTSP-127	1/2 IN	7 IN	NO
4. TLTSP-7820	3/4 IN	20 IN	NO
5. TLT77636	7/8 IN	40 IN.	NO



LARGE ROUND TURF REPAIR
Soil Profile Sampler



Foot operated and spring loaded ejector for quick turf plug removal. Ideal for extracting disease samples and repairing damaged turf.

- Variable depth adjustment 1" - 4"
- Available in 4" & 6" round models
- 4" models ideal for extracting disease samples and turf repair
- 6" model great for damaged turf repair
- Thin blade is heat treated and zinc plated for clean cut

IRRTRP-4 4" WIDE
IRRTRP-6 6" WIDE



SMALL ROUND TURF REPAIR
Soil Profile Sampler



Hand push operated turf plunger/sampler collects plugs in tube stem. Ideal for soil sampling and divot repair on golf greens.

- Variable depth adjustment 1/4" - 4"
- Each plug is pushed up into tube as next plug is taken
- Plunger is zinc plated body and heat treated steel blade
- Solid steel construction for long life

IRRTRP-2 2" WIDE



TRU-DEPTH SAND PROBE
Check Depth of Bunkers

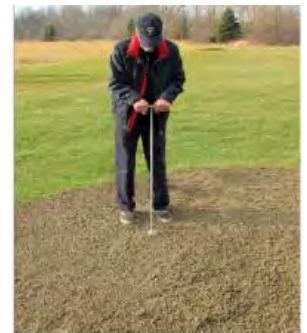

The Tru-Depth Sand Probe provides a quick way to check the depth of bunkers. Simply insert the probe into the sand and quickly read the true compacted sand depth.

- Easily readable ruler
- Measuring depth 0 - 7"
- Aluminum and stainless steel

ACUTRU-07 3" WIDE

GREENS KEEPER LEVEL LAWN



- Available in 30", 36" and 40" models
- Super heavy duty high impact resistant 72" fiberglass handle

IRRTLLG-30K 30" HEAD

IRRTLLG-36K 36" HEAD

IRRTLLC-40K 40" HEAD

PAR AIDE ACCULEVEL



Perfect for soil preparation projects of all kinds – spreading, smoothing and breaking up soil.

- 34" x 10" plated steel head
- 72" lightweight, sturdy aluminum handle – better than wooden handles!

PAR13265 34" WIDE

LEVEL LAWN PULL MASTER



IRRTLLP-72 72" WIDE

LEVEL LAWN PULL MASTER

The ultimate solution for achieving a perfectly even and lush lawn surface.

- A great tool to "level your lawn".
- When reseeding or raising low areas to match the elevation of the surrounding grass.
- Distributes application materials evenly and blends elevations to smooth lawn.
- Helps with top dressing by removing stones from the soil, breaks up small clods of sand or loam.
- Smooths soil for easy planting.



STD29310 30" HEAD W/SPLIT HANDLE

STD29320 36" HEAD W/SPLIT HANDLE

VIPER HAND AERIFIER

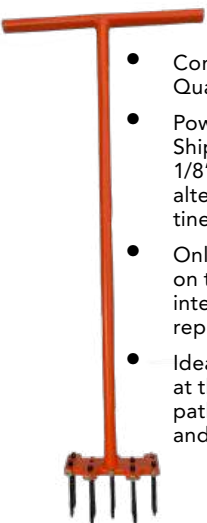

- Comes with 10 Viper Quad Tines
- Powder coated. Shipped with 1/8" MiniQuad or alternative 3/8" mount tine
- Only Hand Aerifier on the market with interchangeable and replaceable tines
- Ideal for "Hot Spots" at the end of cart paths, around ponds and in narrow spaces

SPOT AERIFIER



- Three 1/2" Side-Eject Hollow Tines
- Formed steel flat foot bar base for extra leverage with "T" hand and hand grips for ease of use.

IRRT3TA SPOT AERIFIER

WETTING FORK



- Comes with (3) stainless steel perforated tines.
- Complete with valve and hose fittings for 3/4" and 1" hose.

TLTWF2 WETTING FORK

TURFJECTOR

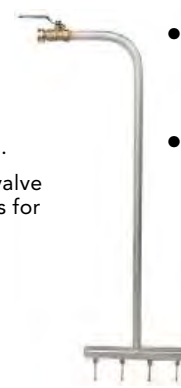

- Features four injector tines that can be inserted up to 2 inches deep.
- Comes with a ball valve to control water flow and connects to a 3/4" hose.



PAR525570 TURFJECTOR
PAR525571 REPLACEMENT TINE

CT14-VHT HAND AERIFIER WITH TINES

SOD STRIPPER
W/Replacement Blade Kit



- Cut a strip of sod for any turf repair
- The ultimate tool for repairing hydraulic leaks
- Solid steel construction with zinc plating
- Blade width available in 2 in., 3 in., 5 in. And 7 in.
- Depth of cut adjustable between 5/8 in. And 1 in.
- 7 in. X 2 in. deep cut blade can be used in conjunction with 7 in. X 2 in. hex-plugger
- Easily strips out damaged area as well as replacement turf from nursery green
- Precut strips on nursery green and then use hex-plugger to cut replacement plugs
- Saves time by eliminating trowel cutting of individual plugs
- Ensures consistent depth of hex plug



- PAR510220** SOD STRIPPER COMBO WITH 2", 3", 5", & 7" BLADES
- PAR510221** SOD STRIPPER COMBO W/ 4 BLADES + 7" X 2" DEEP CUT BLADE
- PAR510212** SOD STRIPPER W/ 2" BLADE
- PAR510213** SOD STRIPPER W/ 3" BLADE
- PAR510215** SOD STRIPPER W/ 5" BLADE
- PAR510217** SOD STRIPPER W/ 7" BLADE
- PAR510218** SOD STRIPPER W/ 7"X 2" DEEP CUT BLADE
- PAR510222** 2 INCH BLADE
- PAR510223** 3 INCH BLADE
- PAR510225** 5 INCH BLADE
- PAR510227** 7 INCH BLADE
- PAR510228** 7"X2" DEEP CUT BLADE

PAR AIDE
HEX PLUGGER



5"W X2"D 7"W X2"D 7"W X3"D

- PAR502105** 5" WIDE X 2" DEEP
- PAR502107** 7" WIDE X 2" DEEP
- PAR502108** 7" WIDE X 3" DEEP

QUICK SEED" II



PAR543564 13" WIDE

ACCUFORM
STAR SPIKER



PAR13256 12" WIDE

PLUG STACKER

Holds 12 Plugs At A Time



PAR1095 TURF PLUGGER

PAR1094 BALL MARK PLUGGER

SPOT OVERSEEDER
& SPIKER



PAR540560 OVERSEEDER

ACCUFORM GREENS EDGER



PAR13260 GREENS EDGER

PAR13261 REPLACEMENT BLADES (3)

TURF ALIGN PRO

NEW PRODUCT!

- Wood dowel with metal needle nose
- Dowel used to smooth and align the plug with the existing turf
- Needle nose spike helps pull up the plug or surrounding turf to align properly
- Rolling out cup holes and ball marks

STD33100



TRI-TOOL

- Repairing ball marks with the stainless-steel coring tine and spike
- Removing weeds
- Coring soil samples
- Leveling cup holes
- Rolling out cup holes and ball marks

PAR1039



EXTENDED RANGE STAINLESS FLAT FAN SPRAY TIPS

The Industry Favorite



80 DEGREE TIPS

110 DEGREE TIPS

TJXR8001VS	ORANGE	TJXR11001VS	ORANGE
TJXR80015VS	GREEN	TJXR110015VS	GREEN
TJXR8002VS	YELLOW	TJXR11002VS	YELLOW
TJXR8003VS	BLUE	TJXR11003VS	BLUE
TJXR8004VS	RED	TJXR11004VS	RED
TJXR8005VS	BROWN	TJXR11005VS	BROWN
TJXR8006VS	GRAY	TJXR11006VS	GRAY

- Excellent spray distribution over a wide range of pressures—15–60 PSI
- Ideal for rigs equipped with sprayer controllers.
- Reduces drift at lower pressures, better coverage at higher pressures



CONTACT HERBICIDES	EXCELLENT
SYSTEMIC HERBICIDES	GOOD
CONTACT FUNGICIDES	EXCELLENT
SYSTEMIC FUNGICIDES	GOOD
CONTACT INSECTICIDES	EXCELLENT
SYSTEMIC INSECTICIDES	GOOD
DRIFT MANAGEMENT	GOOD

EXTENDED RANGE STAINLESS FLAT FAN SPRAY TIPS

Stainless Tip Mounted Complete With Cap



80 DEGREE TIPS

110 DEGREE TIPS

TJXRC80015VS	GREEN	TJXRC11002VS	YELLOW
TJXRC8002VS	YELLOW	TJXRC110025VS	PURPLE
TJXRC8003VS	BLUE	TJXRC11003VS	BLUE
TJXRC8004VS	RED	TJXRC11004VS	RED
TJXRC8005VS	BROWN	TJXRC11005VS	BROWN
TJXRC8006VS	GRAY	TJXRC11006VP	GRAY
TJXRC8008VS	WHITE	TJXRC11008VP	WHITE
		TJXRC11010	LIGHT BLUE
		TJXRC11015	LIGHT GREEN
		TJXRC11020	BLACK

AIR INDUCTION FLAT SPRAY TIPS

CONTACT HERBICIDES
SYSTEMIC HERBICIDES
CONTACT FUNGICIDES
SYSTEMIC FUNGICIDES
CONTACT INSECTICIDES
SYSTEMIC INSECTICIDES
DRIFT MANAGEMENT

GOOD
EXCELLENT
GOOD
EXCELLENT
GOOD
EXCELLENT
EXCELLENT



- Larger droplets for less drift.
- Available in eight capacities with a pressure rating of 30–115 PSI
- Depending on the chemical produces
- Large air-filled Drops through the use of a Venturi air aspirator.



80 DEGREE TIPS

110 DEGREE TIPS

TJAI8002VS	YELLOW	TJAI110015VS	GREEN
TJAI80025VS	PURPLE	TJAI11002VS	YELLOW
TJAI8003VS	BLUE	TJAI110025VS	PURPLE
TJAI8004VS	RED	TJAI11003VS	BLUE
TJAI8005VS	BROWN	TJAI11004VS	RED
TJAI8006VS	GRAY	TJAI11005VS	BROWN
		TJAI11006VS	GRAY
		TJAI11008VS	WHITE

AIR INDUCTION FLAT SPRAY TIPS

Stainless Tip Mounted Complete With Cap



110 DEGREE TIPS

- All tip/cap combinations include Seat Gasket



TJAIC110015VS	GREEN
TJAIC11002VS	YELLOW
TJAIC110025VS	PURPLE
TJAIC11003VS	BLUE
TJAIC11004VS	RED
TJAIC11005VS	BROWN
TJAIC11006VS	GRAY
TJAIC11008VS	WHITE
TJAIC11010VS	LIGHT BLUE
TJAIC11015VS	LIGHT GREEN

TURBO TEEJET SPRAY TIPS

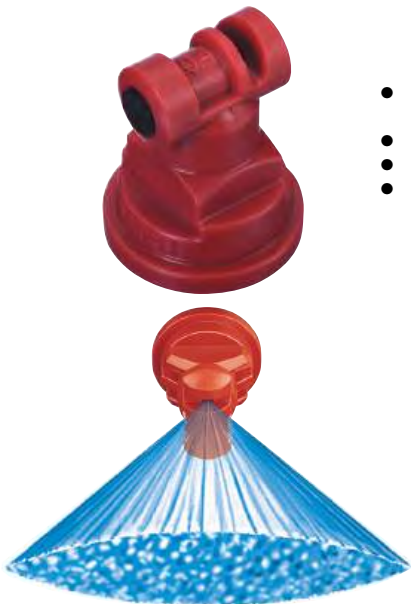

- Tapered edge wide angle flat spray pattern for uniform coverage in broadcast spraying.
- Large, rounded internal passage to minimize clogging.
- Excellent resistance to corrosive solutions.
- Larger droplets for less drift— 15–90 PSI

CONTACT HERBICIDES	VERY GOOD
SYSTEMIC HERBICIDES	VERY GOOD
CONTACT FUNGICIDES	VERY GOOD
SYSTEMIC FUNGICIDES	VERY GOOD
CONTACT INSECTICIDES	VERY GOOD
SYSTEMIC INSECTICIDES	VERY GOOD

TURBO TWINJET TIPS

TJTT11001VP	ORANGE
TJTT110015VP	GREEN
TJTT11002VP	YELLOW
TJTT110025VP	PURPLE
TJTT11003VP	BLUE
TJTT11004VP	RED
TJTT11005VP	BROWN
TJTT11006VP	GRAY
TJTT11008VP	WHITE

AIR INDUCTION TURBO TWINJET DUAL SPRAY TIPS

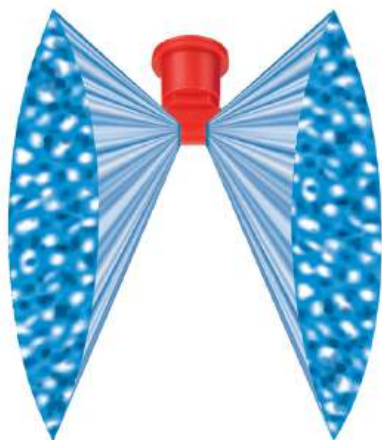

- Air induction with dual 110° flat fan patterns
- 60° between leading and trailing spray patterns
- Good coverage with increased canopy penetration and best drift control
- Excellent drift control with coarse to very coarse droplets
- Pressure ranges from 20–90 PSI



AI TURBO TWINJET TIPS

CONTACT HERBICIDES	GOOD	TJAITTJ6011002VP	YELLOW
SYSTEMIC HERBICIDES	EXCELLENT	TJAITTJ60110025VP	PURPLE
CONTACT FUNGICIDES	GOOD	TJAITTJ6011003VP	BLUE
SYSTEMIC FUNGICIDES	EXCELLENT	TJAITTJ6011004VP	RED
CONTACT INSECTICIDES	GOOD	TJAITTJ6011005VP	BROWN
SYSTEMIC INSECTICIDES	EXCELLENT	TJAITTJ6011006VP	GRAY

TURBO TWINJET FLAT FAN DUAL SPRAY TIPS

- Dual outlet design produces two 110° flat fan spray patterns using the patented technology from the Turbo TeeJet® nozzle.
- The angle between each spray pattern is 60° forward and back.
- Best suited for broadcast spraying where superior leaf coverage and canopy penetration is important.
- Droplet size range is slightly larger than the same capacity Turbo TeeJet nozzle providing drift-reducing properties with increased canopy coverage and penetration.
- Ideal for use with automatic sprayer controllers.



TURBO TWINJET TIPS

CONTACT HERBICIDES	EXCELLENT
SYSTEMIC HERBICIDES	EXCELLENT
CONTACT FUNGICIDES	EXCELLENT
SYSTEMIC FUNGICIDES	EXCELLENT
CONTACT INSECTICIDES	EXCELLENT
SYSTEMIC INSECTICIDES	EXCELLENT
DRIFT MANAGEMENT	VERY GOOD

TJTTJ6011002	YELLOW
TJTTJ60110025	PURPLE
TJTTJ6011003	BLUE
TJTTJ6011004	RED
TJTTJ6011005	BROWN
TJTTJ6011006	GRAY

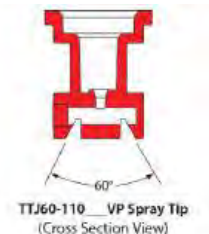



QUICK TEEJET CAPS

The Quick TeeJet caps are designed with grooves that fit locating lugs on the nozzle body. Caps are made of nylon and are available for use with all TeeJet spray tips.

Quick Jet Caps Only - Fits Nozzles Below

- XR Flat Fan Tips - 01-08 Sizes
- Turbo TeeJet
- Turbo twinJet

TJCP25610-1-NYR	BLACK
TJCP25610-2-NYR	WHITE
TJCP25610-3-NYR	RED
TJCP25610-4-NYR	BLUE
TJCP25610-5-NYR	GREEN
TJCP25610-6-NYR	YELLOW
TJCP25610-7-NYR	BROWN



Quick Jet Caps Only - Fits Nozzles Below

- Air Induction
- Turbo Teejet Air Induction
- Turbo Twinjet Air Induction

TJCP25597-1-NYR	BLACK
TJCP25597-2-NYR	WHITE
TJCP25597-3-NYR	RED
TJCP25597-4-NYR	BLUE
TJCP25597-5-NYR	GREEN
TJCP25597-6-NYR	YELLOW
TJCP25597-7-NYR	BROWN



NOZZLE STRAINER

TJ8079-PP-50
50 MESH

TJ8079-PP-100
100 MESH



SEAT GASKET

TJCP19438-EPR

PRESSURE GAUGE



IRPPG100L-4 100 PSI GAUGE

- 1/4" MPT connection
- 4" display
- Stainless Steel case w/ Aluminum gauge

BOOMJET BOOMLESS NOZZLES

- Used for spraying areas not easily accessed with a boom
- Sprayer or for bulk fertilizer applications
- Combine two off-center tips and three VeeJet® nozzles to produce a wide swath flat spray
- The 5880 features a 1/4" gauge port and is supplied with one additional 1/4" NPT pipe plug and one blank tip for spraying to one side only
- The 5430 utilizes a swivel design which can be adjusted to modify the spray pattern width
- Both models feature 3/4" NPT female inlet threads



SPRAY RATES

PSI	GPM	WIDTH	GPA @	GPA @
			4 MPH	5 MPH
20	12.0	56	26	21
30	14.7	60	34	24
40	17.0	63	33	27

PART NUMBER	TYPE
TJ5430-3/4-2TOC40	SWIVEL
TJ5880-3/4-2TOC40	FIXED POSITION

Pricing is subject to change.

TEEJET QUICKJET OUTLET BOOM ADAPTERS

WET BOOM ADAPTERS



- Available with either 3, 4 or 5 spray positions for easy change of spray tips or quick boom flushing.
- Positive shutoff between each spray position.
- Automatic spray alignment using flat fan spray tips.
- Available in 1/2 in, 3/4 in or 1 in single or double hose shanks.
- Includes ChemSaver® diaphragm check valve for drip-free shutoff.
- Standard diaphragm opens at 10 PSI
- Durable design mounts body high on boom structure for maximum protection.

TJQJ363C-1/2-NYB	1/2" CLAMP	3 OUTLET
TJQJ363C-3/4-NYB	3/4" CLAMP	3 OUTLET
TJQJ363C-1-NYB	1" CLAMP	3 OUTLET
TJQJ364C-1/2-NYB	1/2" CLAMP	4 OUTLET
TJQJ364C-3/4-NYB	3/4" CLAMP	4 OUTLET
TJQJ364C-1-NYB	1" CLAMP	4 OUTLET
TJQJ365C-1/2-NYB	1/2" CLAMP	5 OUTLET
TJQJ365C-3/4-NYB	3/4" CLAMP	5 OUTLET
TJQJ365C-1-NYB	1" CLAMP	5 OUTLET

- 3 outlet adapter lets you easily switch nozzles for different applications
- Clamps on to boom pipe

SINGLE NOZZLE BODIES FOR WET BOOMS



- Can be mounted to 20 mm, 25 mm, 1/2 IN, 3/4 IN or 1 IN pipe or equivalent size tubing.
- Features ChemSaver drip-free shutoff. Requires 10 PSI at the nozzle to open check valve

TJQJ17560A-1/2-NYB	1/2" CLAMP
TJQJ17560A-3/4-NYB	3/4" CLAMP
TJQJ17560A-1-NYB	1" CLAMP

SINGLE NOZZLE BODIES FOR DRY BOOMS

- Available with single, double or triple hose shanks for 3/8 in, 1/2 in and 3/4 in I.D. hose.
- Drip-free shutoff with TeeJet ChemSaver Opens at 10 PSI Standard



TJ19349-211-406-NYB	1/2"	1 BARB
TJ19349-211-540-NYB	3/4"	1 BARB
TJ19349-211-785-NYB	1"	1 BARB
TJ19350-212-406-NYB	1/2"	2 BARB
TJ19350-212-540-NYB	3/4"	2 BARB
TJ19350-212-785-NYB	1"	2 BARB
TJ19351-213-406-NYB	1/2"	3 BARB
TJ19351-213-540-NYB	3/4"	3 BARB
TJ19351-213-785-NYB	1"	3 BARB

DRY BOOM ADAPTERS

- Available with either 3, 4 or 5 spray positions for easy change of spray tips or quick boom flushing.
- Positive shutoff between each spray position.
- Automatic spray alignment using flat fan spray tips.
- Maximum operating pressure of 300 PSI
- Available in 1/2 in, 3/4 in or 1 in single or double hose shanks

PART NUMBER	SIZE	BARBS	# OF OUTLETS
TJQJ363C-500-1-NYB	1/2"	1 BARB	3
TJQJ363C-750-1-NYB	3/4"	1 BARB	3
TJQJ363C-1000-1-NYB	1"	1 BARB	3
TJQJ363C-500-2-NYB	1/2"	2 BARB	3
TJQJ363C-750-2-NYB	3/4"	2 BARB	3
TJQJ363C-1000-2-NYB	1"	2 BARB	3
TJQJ364C-500-1-NYB	1/2"	1 BARB	4
TJQJ364C-750-1-NYB	3/4"	1 BARB	4
TJQJ364C-1000-1-NYB	1"	1 BARB	4
TJQJ364C-500-2-NYB	1/2"	2 BARB	4
TJQJ364C-750-2-NYB	3/4"	2 BARB	4
TJQJ364C-1000-2-NYB	1"	2 BARB	4



DRAINAGE

ADS WYE FITTING



IRRADS322AA 3 INCH
IRRADS422AA 4 INCH

ADS TEE



IRRADS321AA 3 INCH
IRRADS421AA 4 INCH

ADS SNAP ON CAP



IRRADS332AA 3 INCH
IRRADS432AA 4 INCH

ADS SNAP ON COUPLING



IRRADS312AA 3 INCH
IRRADS412AA 4 INCH

NDS SQUARE CATCH BASIN



IRRNDS900 9" x 9" 2 OUTLET
IRRNDS900-4 9" x 9" 4 OUTLET
IRRNDS1200 12" x 12" 2 OUTLET
IRRNDS1200-4 12" x 12" 4 OUTLET

NDS DRAIN GRATE



IRRNDS990 9" x 9" GREEN
IRRNDS911 9" x 9" BLACK
IRRNDS1212 12" x 12" GREEN
IRRNDS1211 12" x 12" BLACK

**NDS CATCH BASIN
 OUTLET ADAPTER & PLUG**



IRRNDS1243 3" OR 4" OUTLET
 TO PIPE ADAPTER
IRRNDS1206 OUTLET PLUG



Ideal for 4"- 6"
 drains and catch basins



Perfect for sleeving
 under sidewalks

DRAIN BLASTER

High Pressure Drain Cleaning

This unique hose-end, high pressure nozzle guides itself in cleaning out drains, to remove debris with ease. Special feature includes a wire attachment connector for using wire locator to determine drain route.

- Front jet cuts through blockage
- Rear jets propel nozzle upline
- Two stage flushing action
- Minimum water pressure: 70 psi
- Heat treated grade 303 Stainless Steel for long life
- Great for sleeving under sidewalks or cart paths

IRRDN-75 3/4"
IRRDN-10 1"



Pricing is subject to change.

4 GALLON BACKPACK SPRAYER
SP Pro Spray Systems



TLTSP100 4 GAL SPRAYER

- Professional quality with agitation
- Triple use piston / diaphragm pump

HAND-HELD SPRAYER
SP Pro Spray Systems



TLTYT10 1 GALLON
TLTBL20 2 GALLON

4 GALLON ELECTRIC SPRAYER
Cordless - No Pumping!



TLTSP105E

- 20V Lithium-ion powered. Spray up to 23 tanks on a single charge.
- Constant 40 PSI working pressure to reach farther and wider.
- Lightweight and ultra portable, weighing only 9.6 lbs

12 VOLT SPRAYER
Shurflo Pump, 10' Hose & Wand

- 12 volt connection hooks directly to the battery on any utility vehicle
- Comes with 10 foot spray hose and wand with adjustable nozzle
- 15, 25 or 40 Gallon Poly Tank
- ShurFlo 12 Volt, 1.8 GPM, 60 PSI Diaphragm Pump
- Pressure Demand Switch



PBMES-16 16 GALLON SPRAYER
PBMES-26 26 GALLON SPRAYER
PBMES-44 46 GALLON SPRAYER

ROLLING SPRAY GUN

- Paint or pigment dormant turf with the ultimate precision
- Apply herbicides precisely
- No drift or overspray
- No need to walk in sprayed area
- Nozzles on either side of wheel can be turned on or off
- Quick connect fittings make it easy to connect to sprayer



TLTRSG ROLLING SPRAY GUN
TLTTP8004 REPLACEMENT SPRAY GUN NOZZLE

GREEN SPEED WALKING SPRAY BOOM



- Safe & accurate chemical application
- 5' wide w/ 5 nozzles at 12" spacing
- High-quality spray gun with trigger lock and pressure gauge
- Well-balanced design with pneumatic rubber tires for smooth maneuverability.

TLTWB5

ACCUSPEED WALKING BOOM



BROI-1575D

SPRAY HAWK WALK-BEHIND FOLDING BOOM SPRAYER



Transform your turf maintenance routine with the Spray Hawk Walk-Behind Folding Boom Sprayer, the ultimate solution for precision liquid application. Designed for greens and areas where bulky sprayers simply can't go, this sprayer delivers an impressive 80 inches of coverage while offering unparalleled maneuverability.

- Aluminum Frame (unit weighs 29lbs/13kg)
- 2 x Ball Bearings in each wheel
- Hoses – JVT Rubber 3/4" ID (main) / 1/2" ID (boom)
- 11.8"/30cm Diameter Semi-Pneumatic Tires
- Adjustable Rear Wheel for spray height setting
- 8 x TeeJet Quickjet Nozzles (10" Spacing)
- XR8004VS Nozzle Tips (80° spray angle / 0.4 GPM)
- Horizontal Spacing – 10 in / 25.4 cm
- Vertical Height – Adjustable up to 16 in / 40.6 cm
- Spraying Width – 80 in / 203 cm
- Output Shut-Off Valves – 2: one for each boom section.

SHCD30E-200

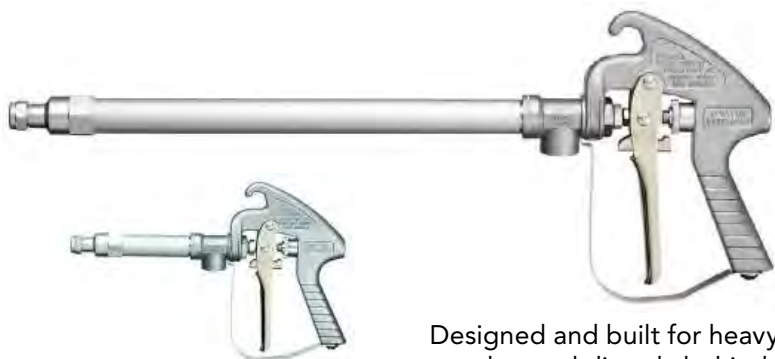

TEEJET GUNJET HAND HELD SPRAY GUNS

Designed and built for heavy duty service. Stem extends through extension to valve seat located directly behind orifice disc for drip-free shutoff and instant operating response. Convenient trigger-lock for continuous spraying.

- Trigger handle control: all models have 1/2" NPT inlet
- Choose orifice size that best matches flow needed
- All orifices spray a 10 foot horizontal swath - distance of throw listed in table below

PART NUMBER	LENGTH	ORIFICE SIZE	FLOW RATE
TJAA43LA-AL6	13"	6	1.2 GPM / 44 FT
TJAAB43LA-AL8	13"	8	2.0 GPM / 45 FT
TJAAB43L-AL4	22"	4	0.6 GPM / 36 ft
TJAAB43L-AL6	22"	6	1.2 GPM / 44 FT
TJAAB43L-AL8	22"	8	2.0 GPM / 45 FT

Pricing is subject to change.

BRASS DRUM FAUCET



- Threads into drum or tote for easy and quick dispersal of product

SHPDV-B

IN-LINE WATER METER



- 1 inch pipe thread - connect to water supply to measure exactly how much water you are putting into spray tank
- Chemical and fertilizer resistant

IRRFM1

ALUMINUM DRUM WRENCH



SHPDW

SPRAYER HOSE

3/8" Braided Hose - 150 PSI



TLTHOSE38

BRASS TIP WAND



- Brass tip
- Fits most models of sprayers
- For use with pump or electric sprayers
- 3/8 inch barb fitting

TLTWAND

12 VOLT SHURFLO PUMP

With Toggle Switch



- Replacement pump fits most portable sprayers
- 12 Volt hooks up to utility vehicle battery
- Comes with on/off toggle switch
- Wire harness is 10 feet long with connection plug on one end and alligator clips on other end with in-line on/off switch

TLTSHU12V 1.8 GPM

TLTSHU3GPM 3 GPM

TLTSHU-WH WIRE HARNESS

GANDY CALIBRATION PANS

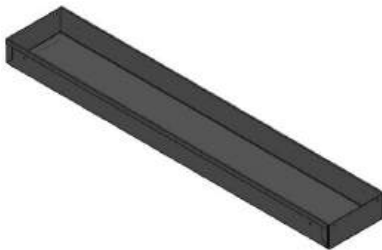

- Calibration pans hang below the spreader to catch and accurately weigh the material coming out. This ensures the most accurate calibration.
- Wire, chain or string to hang to spreader not included with pan.

GAN28248584 24" WIDTH

GAN28368584 36" WIDTH

GANDY DROP SPREADER
Variable Rate Drop Spreaders

- The most reliable and industry favorite drop spreader
- 13" pneumatic wheels
- Adjustable variable-rate stainless steel bottom/slide & steel tri-bar rotor for internal agitation
- Used to apply a variety of seeds, granular chemicals, fungicides, fumigants and fertilizers.



GAN24H13 24" WIDTH

GAN36H13 36" WIDTH

GAN42H16 42" WIDTH

ANDERSONS ROTARY SPREADER

Stainless Steel Frame



- Patented helical cone-adjust spread pattern for better accuracy
- Heavy duty stainless steel frame for long life
- Pneumatic tires
- Right side deflector shield and hopper cover included.

ANDSR2000 **STAINLESS**

ANDERSONS ROTARY SPREADER

Powder Coated Frame



- Painted, steel framed rotary spreader
- Patented helical cone-adjust spread pattern for better accuracy
- Pneumatic tires
- Hopper cover included.

ANDAP2000 **POWDER COAT**

**ECHO 85 LB. HOPPER CAPACITY
STAINLESS STEEL BROADCAST SPREADER**



ECHRB-85S **STAINLESS STEEL FRAME**

**ECHO 85 LB. HOPPER CAPACITY
BROADCAST SPREADER**



ECHRB-85 **POWDER COAT**

SPYKER ROTARY SPREADER

Stainless Steel Frame



SPK80-1S **80 LB. / POWDER COAT**

SPYKER ROTARY SPREADER

Powder Coated Frame



SPK80-1P **80 LB. / POWDER COAT**

ANTI FOAM



IRRAF1Q 1 QUART

SOLD IN CASE OF 12 QUARTS

K KLEAN
Liquid Tank Cleaner



IRRKLEAN01 1 GALLON

SOLD IN CASE OF 4 GALLONS

TANK CLEANER
Powdered Tank Cleaner



IRRTC01 1 LB. BOTTLE

SOLD IN CASE OF 12 BOTTLES

MEASURING CUP SET



- Molded-in handle will not break off
- American standard measurements denoted by red font
- Metric measurements listed in blue font
- Made of virtually unbreakable polycarbonate

IRRCSET

5 CUP SET FROM 8 OZ TO 1 GAL

MEASURING CUPS



- Molded-in handle will not break off
- American standard measurements denoted by red font
- Metric measurements listed in blue font
- Made of virtually unbreakable polycarbonate

IRRC8 8 OZ CUP

IRRC16 16 OZ CUP

IRRC32 32 OZ CUP

IRRC64 64 OZ CUP

IRRC128 128 OZ CUP

BENCHMARK
Marking Foam Solution



IRRBMK01 1 GALLON \$77.50

SOLD IN CASE OF 4 GALLONS

TREATED WITH GREENACTIVATOR



The root sample above is after six treatments with Greenactivator at the recommendation note the increased branching, overall root volume and length, plus the above ground thicker grass density compared to the root sample below that was taken at same time but left untreated.



UNTREATED



GREENACTIVATOR PLUS HUMIC ACID LIQUID FERTILIZER



- A mineral-based liquid fertilizer with a proprietary blend of Humic and Fulvic Acid with a low dose of NPK.
- Increases drought tolerance
- Enhances root development
- Improves plant health by increasing tolerance to disease and pests
- Increases nutrient uptake from the soil
- Absorbs into the plant within 15 minutes, safe for children, pets, and other plants
- Mixes easily with herbicides, pesticides, insecticides, and fungicides – saving you time

STD30000 1 GALLON

STD30002 2.5 GALLON

ECONOMY BOW RAKES

14" HEAD WITH 48" WOOD HANDLE

CORRK10000



LANDSCAPE RAKES

ALL RAKES HAVE A 60" ALUMINUM HANDLE

CORRK61061 24" HEAD

CORRK61063 30" HEAD

CORRK61062 36" HEAD



SPRING BRACE RAKE

22" HEAD WITH 54" WOOD HANDLE

CORRK24003
REPLACEMENT HEAD ONLY

CORRK24003-8

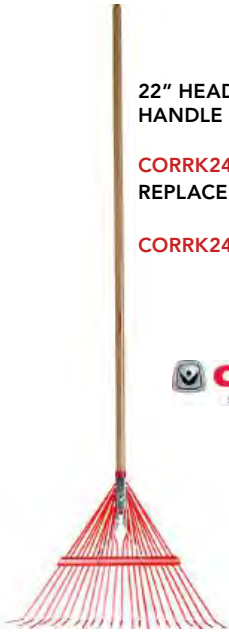

FIXED TINE

19" HEAD WITH 54" WOOD HANDLE

CORRK62001

8" SHRUB HEAD WITH 54" WOOD HANDLE

CORRK62060



EZ-REACHER



TLTER32 32" EZ-REACHER

TLTER40 40" EZ-REACHER

SMALL HAND TOOLS



1



2



3

ITEM	PART NUMBER	DESCRIPTION
1	CORHT69200	PLANTING MATTOCK
2	CORCT3010I	HAND TROWEL
3	CORCT3264	COMFORT GEL HAND SCOOP

RUBBERMAID TRASH CANS



TLTTC10BT 10 GALLON

TLTTC32BT 32 GALLON

DIGGING SHOVELS

Choose the Right One for Your Needs



- CORSS26000** ROUND POINT SHOVEL W/ 48" WOOD HANDLE
- CORSS27000** SQUARE POINT SHOVEL W/ 48" WOOD HANDLE
- CORSS64103** 3" WIDE TRENCHING SHOVEL W/ 48" WOOD HANDLE
- CORSS64104** 4" WIDE TRENCHING SHOVEL W/ 48" WOOD HANDLE
- SEY49454** STRAIGHT BLADE SPADE W/ 30" D GRIP FIBERGLASS HANDLE - GREAT FOR EDGING BUNKERS
- SEY49453** STRAIGHT BLADE SPADE W/ 48" FIBERGLASS HANDLE GREAT TOOL FOR EDGING BUNKERS
- CORPD20000** POST HOLE DIGGER
- CORUT60050** HAND TAMPER

TUFFY POLY SCOOP SHOVEL



- **TLTP6982G**
Made completely of recycled plastic

PLASTIC SCOOP SHOVELS



- 30" D GRIP WOOD HANDLE
CORSS42011
- 48" WOOD HANDLE
CORSS42001



ECONOMY PUSH BROOM

24" HEAD WITH 60" WOOD HANDLE.

CORBM41002



MONSTER BROOM



84" HEAD WITH ALUMINUM HANDLE

SEY82084

STEEL SCOOP SHOVELS



- 30" D GRIP WOOD HANDLE
CORSS68010



OSCILLATING ACTION HOE

4" BLADE WITH 60" WOOD HANDLE
CORSH60000



SINGLE TINE CULTIVATOR
60" Powder Coated Handle

SEY42201

CORONA BYPASS PRUNERS



CORBP3180 1" PRUNER
CORBP3160 3/4" PRUNER

CORONA LEATHER SCABBARD



CORAC7220

CORONA GRASS SHEARS



CORGS6750

CORONA TREE PRUNER

Dual Compound Action - 14'



CORTP6870

- Dual Compound action
- Reaches up to 14 Feet
- 13" saw blade
- heavy duty chain drive
- Replacement parts available

CORONA ORCHARD LOPPER

Aluminum Handle - Cuts 2.25" Dia.



CORAL8482 HIGH-PERFORMANCE 36"
CORAL8462 HIGH-PERFORMANCE 32"
CORAL8442 HIGH-PERFORMANCE 26"

CORONA HEDGE SHEAR

9.5" Handle



CORHS6960 SMOOTH BLADE
CORHS6920 SERRATED BLADE

FOLDING RAZOR TOOTH SAW



CORRS7265D 10" RAZOR TOOTH

CORONA PRUNING SAW

13" Razor Tooth



CORRS7120 13" SAW

CORONA PRUNING SAW



CORRS7160 21" RAZOR TOOTH SAW

CORONA MACHETE



CORMA60062 22" BLADE
CORMA60061 18" BLADE



Pricing is subject to change.

WHICH TINE IS RIGHT FOR YOU?

- **HEAT TREATED STEEL** - This is our normal tine material that gives you a good quality tine for an affordable cost. This may be a good option where you may hit gravel or rocks and the tine may break no matter what material it is.
- **CARBIDE TIP** - Hardened tip designed for lasting durability. The downside to carbide tip tines is that they may pull the turf up a little and they can wear out above the tip.
- **PHOENIX HARDENED STEEL** - These tines mean you don't have to choose between a long-life, durable carbide tipped coring tine or a clean efficient cut and core with a standard heat treated tine. Phoenix provides both including significantly reduced 'grow-in' period and rust resistance for longer life.

AERIFICATION DISPLACEMENT CHART

This chart can be used to help determine the amount material removed by varying tine size and spacing. Many factors can influence actual results, so use this chart solely as a reference.

TINE SIZE	1.25" X 1.25" SPACING	1.5" X 1.5" SPACING	2" X 2" SPACING	2.5" X 2.5" SPACING	5" X 5" SPACING
1/4"	3.14%	2.18%	1.23%	.79%	
3/8"	7.07%	4.91%	2.76%	1.77%	
1/2"	12.57%	8.73%	4.91%	3.14%	
5/8"		13.64%	7.67%	4.91%	

Look For The Orange Colored Rows For Phoenix Options



Quad Tine Side Eject Coring Tines

PART NUMBER	TINE DIAMETER	TINE LENGTH	TINE MOUNT
CTI1Q-255037	1/4"	5"	3/8"
CTI1Q-375037	3/8"	5"	3/8"
CTI1Q-376037	3/8"	6"	3/8"
CTI1Q-525037	1/2"	5"	3/8"
CTI1Q-526037	1/2"	6"	3/8"
CTI1Q-625037	5/8"	5"	3/8"
CTI1Q-626037	5/8"	6"	3/8"
CTI1QC-255037	1/4" - CARBIDE TIP	5"	3/8"
CTI1QC-375037	3/8" - CARBIDE TIP	5"	3/8"
CTI1QC-525037	1/2" - CARBIDE TIP	4 5/8"	3/8"
CTI1QC-526037	1/2" - CARBIDE TIP	5 5/8"	3/8"
CTI1QC-625037	5/8" - CARBIDE TIP	5"	3/8"
CTI1QC-626037	5/8" - CARBIDE TIP	6"	3/8"



HOLES PUNCHED WITH
VIPER NOSE QUAD TINES

HOLES PUNCHED WITH
STANDARD MINI QUAD
TINES

VIPER NOSE QUAD TINES

A Game Changer In Core Aeration

- Viper Nose Quad Tines are a new and unrivaled family of cutting edge quad tines that are minimally intrusive but remove maximum material.
- Remove maximum thatch and material from your Greens
- Have the advantage of minimal disruption to play and fast recovery times while still removing maximum material
- Get maximum durability and longevity out of Viper Nose Quad Tines because of their unique manufacturing process and special heat treating
- Minimal to no plugging of tines during aerification
- Compare to ninja tines in disruption to putting surface, but removes much more material

PART NUMBER	TINE DIAMETER	TINE LENGTH	TINE MOUNT
CTI1QV-134337	1/8"	4.3"	3/8"
CTI1QV-255037	1/4"	5"	3/8"
CTI1QV-375037	3/8"	5"	3/8"
CTI1QV-525037	1/2"	5"	3/8"
CTI1QV-526037	1/2"	6"	3/8"
CTI1QV-625037	5/8"	5"	3/8"



VENT TINES (BAYONET/SLICING TINES)

- Modified Talon design where the hole remains open and continues to provide gas and water exchange
- Offer exceptional plant respiration benefits for up to three weeks
- Promote drainage and prepare surfaces for sodding, hot spots, or as a pre-seeding prep process
- Resume play immediately after an aerification with little or no impact on putting

PART NUMBER	TINE DIAMETER	TINE LENGTH	TINE MOUNT
CTI2V-626037	5/8"	6"	3/8"
CTI2V-7511070	3/4"	11"	18 mm
CTI2V-754750	3/4"	4.75"	1/2"
CTI2V-754762	3/4"	4.75"	5/8"
CTI2V-756037	3/4"	6"	3/8"
CTI2V-756075	3/4"	6"	3/4"
CTI2V-757037	3/4"	7"	3/8"
CTI2V-757047	3/4"	7"	12 mm
CTI2V-757075	3/4"	7"	3/4"
CTI2V-759547	3/4"	9.5"	12 mm
CTI2VW-759547	3/4"	9.5"	12 mm dimple



TALON TINES (CROSS TINES)

- Designed to maximize surface area and minimize plant trauma
- Minimum disturbance to the green so it is possible to resume play immediately after an aerification with little or no impact on putting
- The 'root severing' action promotes root branching for a stronger, healthier root mass
- Improves gas exchange in the soil during hotter months

PART NUMBER	TINE DIAMETER	TINE LENGTH	TINE MOUNT
CTI2T-106075	1"	6"	3/4"
CTI2T-374750	3/8"	4.75"	1/2"
CTI2T-376037	3/8"	6"	3/8"
CTI2T-376075	3/8"	6"	3/4"
CTI2T-504737	1/2"	4.75"	3/8"
CTI2T-506037	1/2"	6"	3/8"
CTI2T-506075	1/2"	6"	3/4"
CTI2T-754737	3/4"	4.75"	3/8"
CTI2T-756075	3/4"	6"	3/4"

Pricing is subject to change.

MACHINE ALLOY SIDE EJECT CORING TINES



PART NUMBER	TINE DIAMETER	TINE LENGTH	TINE MOUNT
CTI1S-505075	1/2"	5"	3/4"
CTI1S-506075	1/2"	6"	3/4"
CTI1S-624575	5/8"	4.5"	3/4"
CTI1S-625075	5/8"	5"	3/4"
CTI1S-626075	5/8"	6"	3/4"
CTI1F-756075	3/4"	6"	3/4"

CARBIDE TIP SIDE EJECT CORING TINES



PART NUMBER	TINE DIAMETER	TINE LENGTH	TINE MOUNT
CTI1CS-374562	3/8" - CARBIDE TIP	4.5"	5/8"
CTI1CS-376075	3/8" - CARBIDE TIP	6"	3/4"
CTI1CS-505075	1/2" - CARBIDE TIP	5"	3/4"
CTI1CS-625075	5/8" - CARBIDE TIP	5"	3/4"

FAIRWAY SIDE EJECT CORING TINES



PART NUMBER	TINE DIAMETER	TINE LENGTH	TINE MOUNT
CTI1FP-756075	3/4" - PHOENIX	6"	3/4"
CTI1F-756075	3/4"	6"	3/4"
CTI1F-756087	3/4"	6"	7/8"
CTI1FC-756075	3/4" - CARBIDE TIP	6"	3/4"
CTI1FCH-816075	13/16"	6"	3/4"
CTI1FCH-875587	7/8"	5.5"	7/8"

ECONOMY ROLLED SIDE EJECT CORING TINES



PART NUMBER	TINE DIAMETER	TINE LENGTH	TINE MOUNT
CTI1E-625775	5/8"	5.75"	3/4"
CTI1E-625787	5/8"	5.75"	7/8"
CTI1E-755775	3/4"	5.75"	3/4"
CTI1E-755787	3/4"	5.75"	7/8"
CTI1E-108510	1" - CLOSED SPOON TINE	8.5"	2 BOLT
CTI1E-757575	3/4" - CLOSED SPOON TINE	7.5"	1 BOLT



SOLID ROUND TINES

- Made of 4140 alloy steel and designed to provide the longest life possible
- Great for fairways, tees & surrounds



PART NUMBER	TINE DIAMETER	TINE LENGTH	TINE MOUNT
CTI2-204537	20"	4.5"	3/8"
CTI2-205537	20"	5.5"	3/8"
CTI2-254037	1/4"	4"	3/8"
CTI2-255037	1/4"	5"	3/8"
CTI2-255050	1/4"	5"	1/2"
CTI2-255075	1/4"	5"	3/4"
CTI2-256037	1/4"	6"	3/8"
CTI2-256075	1/4"	6"	3/4"
CTI2-375037	3/8"	5"	3/8"
CTI2-375050	3/8"	5"	1/2"
CTI2-375075	3/8"	5"	3/4"
CTI2-376037	3/8"	6"	3/8"
CTI2-376075	3/8"	6"	3/4"
CTI2-505075	1/2"	5"	3/4"
CTI2-506037	1/2"	6"	3/8"
CTI2-506075	1/2"	6"	3/4"
CTI2-625075	5/8"	5"	3/4"
CTI2-626037	5/8"	6"	3/8"
CTI2-626075	5/8"	6"	3/4"
CTI2-627075	5/8"	7"	3/4"
CTI2-755075	3/4"	5"	3/4"
CTI2-755087	3/4"	5"	7/8"
CTI2-756075	3/4"	6"	3/4"
CTI2-757075	3/4"	7"	3/4"
CTI2-757087	3/4"	7"	7/8"
CTI2-875087	7/8"	5"	7/8"
CTI2-877087	7/8"	6.5"	7/8"
CTI2-106075	1"	6"	3/4"
CTI2P-255037	1/4" - PHOENIX	5"	3/8"
CTI2P-256037	1/4" - PHOENIX	6"	3/8"
CTI2P-375037	3/8" - PHOENIX	5"	3/8"



L NEEDLE TINES

- L shaped design for needle tine mounting block
- Great tool for gas exchange during hot months

PART NUMBER	TINE DIAMETER	TINE LENGTH
CTI2E-204920	1875"	4.875"
CTI2E-206520	5MM	6.5"
CTI2E-314931	.3125"	4.875"
CTI2E-317531	5/16"	7.5"



PAR546571 TORO PROCORE 648 (SET OF 6)

JOB SAVER TINES

- The best tool for rapid repair of damaged turf.
- Overseeding greens becomes easier than ever with exclusive attachments for your power aerifier
- Beefed up the spring action stripper plates prevent tearing or lifting of turf
- Precision crafted from the highest quality materials to perform at peak operating levels.
- Preparing the perfect seed bed with a "jobsaver" allows an area to be kept in play.
- The 1/4" diameter spikes create the perfect seed bed, yet allow areas to be kept in play
- Keeps greens in play during seeding process
- 72 holes per stroke, sold in a set of 6

CORE COLLECTOR

Collects and Piles Plugs

The Turf Pride Core Collector is an accessory that can save you time and labor costs when core removal is necessary.

- As your aerifier is operating, the Core Collector picks up, contains and moves the cores to the collar
- Cores are deposited on collar when aerator is lifted at end of pass
- Can be mounted in a matter of minutes on walk behind and tractor drawn aerifiers & removal is just as simple
- Optional brush attachment helps work in topdressing sand at the same time.



TP-CC-48-T TORO PRO CORE 648

TP-CC-36-T TORO MODEL 09120

TP-CC-86-T TORO 864

TP-CC-40-D JOHN DEERE 1000

TP-CC-36-D JOHN DEERE 800

TP-CC-60-D JOHN DEERE 1500

TP-CC-24-GA RYAN GREENSAIRE 24

TP-CC-30-GA RYAN GREENSAIRE 30

TP-CC-48-T-TP SPECIAL BOTTOM THIN PLATE FOR COLLECTING 1/4" PLUGS ONLY

TP-CC-BA BRUSH ATTACHMENT

OPTIONAL BRUSH ATTACHMENT

CORE HOG

Limited Quantity Available



PAR1075 UNIVERSAL

PAR1076 TORO FLEX 21

ACCUFORM PLUG PUSHER

36" (91.4 cm) Aluminum Head



PAR13240

CUP PLUGS

Protect Holes While Aerifying



Packaged in sets of 9

PAR1070 REGULATION CUP

PAR1071 PRACTICE CUP

SWEEP-N-FILL TURF BRUSH



- Eliminates bruising and turf injury
- Removes grain from putting surface
- Fills aerified holes in only 2 – 3 passes
- Provides fastest clean up of aerified greens
- Lifts lateral shoots and matted turf
- Reduces need for verticutting and vertical grooming
- 6" ground clearance in transport mode
- Can be pulled by golf cart or light truckster
- 54" working width, 66" overall width



TLTSNFTB

GREENSGROOMER

- The GreensGroomer® is an integral part of a total turf conditioning program and won't scuff, bruise, or damage turf.
- Effectively moves both wet and dry topdressing.
- Brushes off heavy dew and grass clumps.
- Equally balanced for smooth operation.
- assists in controlling grain, promotes leaf healthiness and grass density, and can reduce the frequency of verticutting.
- Choose between Black premium brushes or white heavy duty brushes



ORIGINAL GREENSGROOMER

- GRG920E** GREENSGROOMER W/ PREMIUM BRUSHES
- GRG920H** GREENSGROOMER W/ HEAVY DUTY BRUSHES
- GRG230000** REPLACEMENT BRUSH SET - PREMIUM
- GRG920100** REPLACEMENT BRUSH SET - HEAVY DUTY
- GRG944HD** FAIRWAY GROOMER W/ HEAVY DUTY BRUSHES
- GRGSTR2** SPRING TINE ATTACHMENT



FAIRWAY GROOMER



Pricing is subject to change.

DEW DRAGGIN OR GREEN DRAGGIN
Quickly Remove Dew By Hand Or Behind A Cart

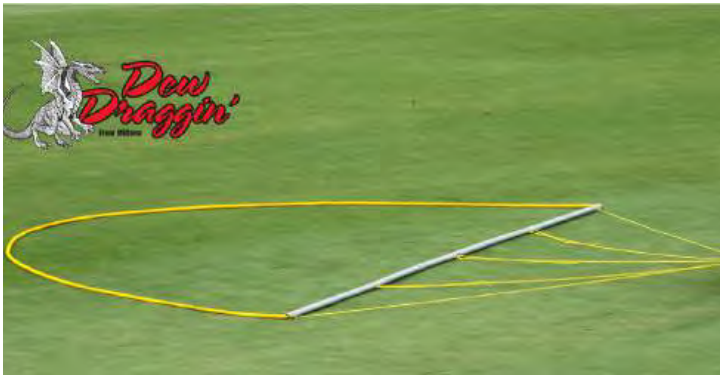

- A fast and cost effective way to remove dew or disperse clippings from fairways or Greens.
- The dew draggin is 25 feet wide and only 30 pounds.
- Optional handle attachment allows you to use on Greens without a vehicle.

PAR555690 DEW DRAGGIN

DRAG BRUSH
Center Unit Only



STD52000 CENTER DRAG UNIT

STD52013 54" REPLACEMENT BRUSH (REQUIRES 2 BRUSHES)

- Long-time classic and favorite among superintendents.
- Gently and evenly works top dressing material into the green and helps control thatch when used before mowing.
- Extensions available for bigger jobs; hinged and weighted to help manage contours and uneven areas.
- 26" H x 54-1/2" W

DRAG BRUSH
Wing Units Only



STD52050 WING UNITS ONLY (SET OF 2)

STD52063 27" REPLACEMENT BRUSH (4 BRUSHES REQUIRED FOR BOTH WINGS)

EASY SWEEP FAIRWAY DRAG NETS



- The easiest and most affordable method to break up grass clippings in fairways and roughs
- Pull with cart or mount behind fairway or rough mower
- Highest quality drag nets available
- Drag net does not include frame - use PVC or stock metal to mount to cart or mower
- Reduces labor costs and improves turf conditions
- Rolls up - Easy to store and transport
- Cultural practice to prevent DOLLAR SPOT
- # 42 uv treated 2" mesh heavy duty polyester netting
- 3/8" braided rope perimeter
- 3/8" Galvanized chain
- Choose whether you want 1 or 2 chains

PWFND7X11-1 7 FEET WIDE X 11 FEET LONG - 1 CHAIN

PWFND7X11-2 7 FEET WIDE X 11 FEET LONG - 2 CHAINS

PWFND10X12-1 10 FEET WIDE X 12 FEET LONG - 1 CHAIN

PWFND10X12-2 10 FEET WIDE X 12 FEET LONG - 2 CHAINS

SANDPIPER COCOMAT
Complete Mats With Tow Assembly



- The original, high quality mat
- Natural cocoa fibers offer superb brooming action.
- Thick backing provides multi-season use.
- Quick effective filling of aerated holes.
- Won't damage tender grasses as a chain mat will.
- Versatile mounting harness - tow with a cart, mower or any prime mover.
- Can be used alone or in conjunction with mechanical top dressers
- Towing frame & all components are weather tolerant

**SHIPPED FULLY ASSEMBLED, READY TO WORK.
SPECIAL SIZES AND REPLACEMENT MATS AVAILABLE.**

COC4X6 4' X 6' MAT

COC5X6 5' X 6' MAT

COC6X6 6' X 6' MAT

COCO DRAG MOP

Touch Up Areas Or Get Those Hard to Reach Spots - Great for Baseball Infields



- Perfect for small job sites, spot touch up after aerification or areas that are hard to reach with an utility vehicle
- Uses the same material as a pull behind coco mat
- Great for infield skin on baseball fields
- Mop comes with a 66 inch aluminum handle
- Mop head is 24 inches x 24 inches

STD53060

MONSTER BROOM

- Perfect for small job sites, spot touch up after aerification or areas that are hard to reach with an utility vehicle
- 84" wide head
- Lightweight and easy to pull behind



84" HEAD WITH ALUMINUM HANDLE

SEY82084

24" PUSH BROOM

2-Bristle Design, Bamboo Handle



- Ideal for sweeping sidewalks, concrete slabs and floors
- Features both coarse and fine 3 in. bristles for greater efficiency
- 24 in. Wide head for single-pass removal of unwanted material
- 60 in. Bamboo handle offers improved strength-to-weight ratio

CORBM41002

Pricing is subject to change.

KEYSTONE DRAG MATS

Flexible Style



This heavy duty, all purpose mat is a standard maintenance tool on golf courses and sports fields. Whether for dragging the infield or breaking up aerification plugs, this mat does it all. Our mats come with the tow rope and hardware included.

- Heavy duty
- Rust resistant galvanized finish
- Reversible - use either side
- Rolls up like a carpet for easy cleaning
- Smooth, level surface
- Rugged construction

- KEY48X48** 4'W X 4'L DRAG MAT
- KEY48X60** 4'W X 5'L DRAG MAT
- KEY48X72** 4'W X 6'L DRAG MAT
- KEY60X60** 5'W X 5'L DRAG MAT
- KEY72X72** 6'W X 6'L DRAG MAT
- KEY72X96** 6'W X 8'L DRAG MAT
- KEY60X72** 5'W X 6'L DRAG MAT
- KEY36X48** 3'W X 4'L DRAG MAT

Flexible steel drag mats can be customized into nearly any size. Call for other options.

KEYSTONE DRAG MATS

HD Series



- A Par West Exclusive Product, the hd series drag mat is a bulkier version of the keystone mat
- Adds more weight and heavier duty for working sand topdressing into fairways
- Breaks fairway plugs up better on fairways
- Over 3 times as strong as the original keystone mat

- KEYHD48X48** 4'W X 4'L MAT
- KEYHD72X48** 6'W X 4'L MAT
- KEYHD72X72** 6'W X 6'L MAT

Call for other available size options.



CORE BUSTER DRAG MAT

Break up cores easier, faster, and better than ever before. The new Core Buster Drag Mat is the best performing and most versatile drag mat available



- PAR1081** DRAG MAT I: 160" X 60" (8 PANEL X 3 PANEL)
- PAR1080** DRAG MAT II: 100" X 60" (5 PANEL X 3 PANEL)
- PAR1080-10** INDIVIDUAL PANEL (20 IN. X 20 IN.)
- PAR1080-11** HARDWARE KIT
- PAR1080-12** DRAW BAR

HIGH TRAFFIC MATTING



- Porous construction eliminates standing water
- Allows for moisture evaporation eliminating algae growth
- Trims easily with razor knife for custom installations
- Excellent weather-ability: -35 F - 180 F
- Cleans easily with sweeping or by hose
- Reduces the risk of slippage
- Able to withstand high levels of traffic

PEM210 2' WIDE X 10' LONG ROLL

PEM225 2' WIDE X 25' LONG ROLL

PEM310 3' WIDE X 10' LONG ROLL

PEM325 3' WIDE X 25' LONG ROLL

PEM610 6' WIDE X 10' LONG ROLL

PEM625 6' WIDE X 25' LONG ROLL

PEMSB190 SURE BOND ADHESIVE

PEMSK-10 10' SEAM REINFORCEMENT KIT

PEMSK-100 100' SEAM REINFORCEMENT KIT

PEMS STAINLESS STEEL SCREWS (100)

PEMSW STAINLESS STEEL WASHERS (100)

PEMSB BLACK STAINLESS SCREWS (100)

PEMSBW BLACK STAINLESS WASHER (100)



BLUE



BLACK



SANDSTONE



CHOCOLATE BROWN



GRAY



HUNTER GREEN



Pricing is subject to change.

RR FLOOR PROTECTOR ROLLS

3/8" x 4' x Custom Length

- Excellent for bridges and high traffic areas
- Environmentally friendly resilient non-porous flooring
- Shock Absorbent. Slip Resistant (Wet & Dry Areas).
- Not effected by cold weather; will not expand or become brittle or hard
- Will not harbor or promote bacteria
- 3/8" (9.5mm) – for heavy duty commercial applications

TLTRR3825BK 3/8" X 4' X 25' - BLACK

TLTRR3850BK 3/8" X 4' X 50' - BLACK



GEOGRID CELLULAR PAVING SYSTEM

For Landscaping Stabilization and Erosion Control

- 25 Ton Load Capacity
- 19.5"X19.5"X1.6"
- 100% recycled high-density polyethylene (HDPE)
- Interlocking design for fast installation
- Durable and lightweight
- Can be filled in with decorative stones, seeded with grass or with high visibility inserts
- GeoGrid® ground reinforcement and stabilization grids can equal or better the axle or point load performance of other currently available 40mm or 50mm cellular geopavers.

TLTGEO20 BLACK TILE



NEW PRODUCT!

MAMBAMAT® COMPOSITE MAT

Turf Protection / Traffic Mat - 95 Ton Capacity

- Ergonomic orientation with 8 standard hand holes, significantly improves ease of handling for users
- Designed to support weights of up to 95 tons helping to preserve the condition of the property, avoiding expensive repair or restoration expenses
- Reliable pedestrian traction mitigates the risks of accidents and injuries
- Flexible construction follows the contours of the ground, delivering effective access solutions on sloping or undulating ground conditions
- All mats ship freight truck

TLTMM28 2 FEET X 8 FEET

TLTMM36 3 FEET X 6 FEET

TLTMM38 3 FEET X 8 FEET

TLTMM48 4 FEET X 8 FEET



Discounts for orders over 10 units.

- Cushion-Tred™ is made from a resilient rubber compound that can withstand many of the commonly found industrial chemicals, cutting fluids, oils, and greases.
- A large hole drainage system facilitates the removal of liquid and debris from the work area.
- Multiple mats can be affixed together with optional connector strips

TLT55050033BL 3 FEET X 3 FEET

TLT550S0035BL 3 FEET X 5 FEET

CUSHION TREAD
Safety And Anti-Fatigue Matting



**EVERGREEN TURF COVERS
CALL FOR PRICING**

7 YEAR WARRANTY

WHITE ORIGINAL TURF COVER

EVG10X50W	10' x 50'
EVG20X50W	20' x 50'
EVG50X60W	50' x 60'
EVG60X90W	60' x 90'
EVG70X90W	70' x 90'
EVG80X110W	80' x 110'

CUSTOM SIZES

10 YEAR WARRANTY

GREEN PREMIUM TURF COVER

EVG10X50G	10' x 50'
EVG20X50G	20' x 50'
EVG50X60G	50' x 60'
EVG60X90G	60' x 90'
EVG70X90G	70' x 90'
EVG80X110G	80' x 110'

CUSTOM SIZES

12 YEAR WARRANTY

SILVER RADIANT TURF COVER

EVG10X50S	10' x 50'
EVG20X50S	20' x 50'
EVG50X60S	50' x 60'
EVG60X90S	60' x 90'
EVG70X90S	70' x 90'
EVG80X110S	80' x 110'

CUSTOM SIZES



How An Evergreen Turf Cover Can Help You

- Increase soil temperatures by 10 degrees
- Speed up germination rates
- Reduce or eliminate foot traffic
- Retain moisture

TURF PROTECTION MESH

The durable net protects new turf from wheel rutting and ensures a good grasp for grass roots.

- Looks natural
- Reduces stormwater run off
- Resists wheel rutting that damages new grass
- Net ensures deep grass roots for healthy grass
- UV stabilized for long-lasting "go green" color
- Secure perimeter using inexpensive tenax staples every 3 ft.
- Use to protect the ground from damage caused by vehicles, pedestrians, and more
- Highly recommended to install in the spring and fall growing seasons for best results
- Versatile and can be used in commercial and residential areas in need of ground protection



TLTTRMAT 6'7" X 100' ROLL

SEED GERMINATION BLANKET



- 1.5 oz thick for maximum warmth
- Great for improving the speed of germination by trapping heat and moisture
- Lightweight and easy to use
- UV stabilized
- Sized special for long areas of divots

GCATC-7X50	7' x 50'
GCATC-6X100	6' x 100'
GCATC-10X100	10' x 100'
GCATC-14X100	14' x 100'
GCATC-12X500	12' x 500'

Pricing is subject to change.

- Easily picks up grass, leaves, twigs, and debris
- Comes with 10 cu ft capacity mesh bottom basket, solid bottom optional for additional cost
- highest quality drag nets available
- Polypropylene, steel-backed brushes
- 8 Brushes, staggered in four rows
- Variable height adjustment independent of the frame
- 10-1/2" X 2-1/2" wheels
- Easily towed by any equipment with a rear hitch hole 3/8" galvanized chain
- Tow with a front engine tractor, zero turn mower, atv, or golf cart
- Single unit or triple gang

SWEEP-RITE LAWN SWEEPER



Rear Brush & Magnet Add-on



- TP-SR-1000-4** SINGLE SWEEP UNIT
- TP-SR-3000-4** TRIPLE GANG SWEEP UNIT
- TPP360904** MAGNET ADD-ON
- TPP360905** REAR BRUSH KIT ADD-ON
- TPP360906** HOPPER EXTENSION ADD-ON

FLOOR OPTIONS (MUST SELECT 1 WHEN ORDERING)

- P360900** STEEL MESH FLOOR
- P360901** NON-MESH NYLON FLOOR
- P360902** SOLID FLOOR

- Engineered for professional turf maintenance.
- Available in 11', 15', and 17' tow behind models and 3-point hitch versions
- Include full width rear and front roller, and on the 3-point hitch models standard with front casters for trimming around bunkers and cart paths.
- offset hitch providing close cuts around trees and bushes, greatly improving production and reduce the need for string trimmer. Variable Height Adjustment independent of the frame
- Medium and heavy duty blades are also available.

ROLLER MOWER



- TP-GT-3130** ROLLER MOWER, 11'
- TP-GT-3180** ROLLER MOWER, 15'
- TP-GT-3204** ROLLER MOWER, 17'

THREE POINT HITCH FINISH MOWER

Turn Your Tractor Into A Turf Mowing Machine

- 43" – 57" – 72" Cutting Widths
- Minimum Required HP 15-35 to meet the needs of today's
- Quick Hitch compatibility on all models allows for easier hook up
- Contour of terrain with 3 anti-scalp rollers
- Cutting height adjustment is made with quick placed spacers from 1/2" to 3"
- Adjustable Spring-Loaded idlers maintain proper belt tension



- TP-TPH-GT143** 43" CUT
- TP-TPH-GT157** 57" CUT
- TP-TPH-GT172** 72" CUT
- TP-TPH-GT143-R** 43" CUT EQUIPPED W/ REAR ROLLERS
- TP-TPH-GT157-R** 57" CUT EQUIPPED W/ REAR ROLLERS
- TP-TPH-GT172-R** 72" CUT EQUIPPED W/ REAR ROLLERS

Visit www.parwest.com or call us directly for more information and videos on all three products!

198 POWER EQUIPMENT



GREENMAN 19"
Hover Mower



- Maruyama CER800U 2-stroke engine
- Wide-ranging 52" adjustable handles provide extreme reach on sloped surfaces
- Mulches as it cuts
- Engine stop system using the convenient OPC lever for added safety
- **California Compliant**

- GHG190** 19" 2-CYCLE ENGINE
- GH3010670** TRI-BLADE SET (SET OF 3)
- GH3010700** 19" STRAIGHT/BAR BLADE
- GH4012561-M** 18" HANDLE EXTENSION KIT (MARUYAMA ENGINE)
- GHHR-190** HIGH-RISE KIT (1.9" INCREASE IN CUTTING RANGE)



STANDARD STAINLESS STEEL BLADE SYSTEM
Hardened Stainless Steel
Reversible and Sharpenable



QC BLADE SYSTEM
Hardened Stainless Steel
Surrounded By Nylon Casing

- AFF-15** 15", 2 CYCLE JAYU ENGINE (NOT AVAIL. IN CA)
- AFF-19** 19" DUCAR 4 CYCLE ENGINE (NOT AVAIL. IN CA)



AIR FORCE
Hover Mower



Air Force offers the best power, performance and durability. Better materials and modern construction methods make Air Force the best hover mower.

- STANDARD SS BLADE SYSTEM** **QC BLADE SYSTEM**

ADD-ONS & REPLACEMENT PARTS

- AFSE00603** QC BLADE KIT (PACK OF 6)
- AFSE01206** QC BLADE KIT (PACK OF 60)
- AFSEO2412** STAINLESS BLADES (PACK OF 3)
- AFSE18370** BLADE BOLT KIT (PACK OF 3)
- AF1222** DISC ONLY FOR 19" HOVER MOWER
- AF1519** DISC ONLY FOR 15" HOVER MOWER

POWER TRIM COMMERCIAL EDGER

- The industry standard for edging cart paths and curbs
- 4 HP honda engine
- All parts available in equipment maintenance section of this catalog

- PWT308H** 118CC HONDA ENGINE
- PWT200-8** 127CC BRIGGS & STRATTON ENGINE



POWER TRIM POWER BRUSH

- The industry standard for edging cart paths and curbs
- Honda GX35N Engine
- Bristle Brush Dimensions L – 22 inches x W 10 inches
- Great for artificial turf fields and backyard putting greens

PWTPBR-1000



ATOM PRO CART PATH EDGER

Walk Behind Edger

- Safety Throttle Interlock with 1/2 Throttle Lock for Easy Starting & Finger Tip On/Off Ignition Switch
- Powerful Honda Durable Full Crank Commercial Engine
- Fully Enclosed Solid Steel 12mm Precision Ground Transmission Shaft
- Large 150mm (6") Rubber Tyred Wheel with Axle Seals



ATOM WIRE WHEEL BRUSH EDGER BLADE

- ATMCPE4-MAX** ATOM MAX PRO - HONDA GX 50CC
- ATMCPE4** ATOM PRO - HONDA GX 35CC
- ATMAT49000** WIRE BRUSH BLADE
- ATMATM43105** BLADE SET

ATOM DELUXE EDGER

Award-Winning Lawn Edger

- Safety Throttle Interlock and fingertip on/off ignition
- Easy lifting carrying handle
- highly maneuverability wheelbarrow action means you can edge along curbs and gutters, around tight corners, garden plots, and by simply tilting the edger sideways you can edge up against walls and fences
- Quality 25cc Honda 4-Stroke engine.

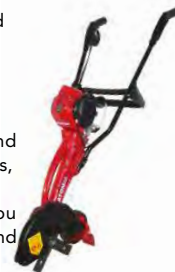

- ATMDLX** DELUXE EDGER
- ATMATM43105** BLADE SET

ATOM TILLER

Award-Winning Soil Tiller

- Extra wide 13' width tines or industry standard 9' width tines
- 6-position adjustable wheel to vary the soil depth
- Its breakthrough ergonomic design makes it easy to till soils
- Quality 25cc Honda 4-Stroke engine.

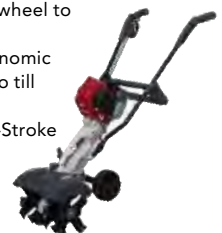

ATMTILH6

Pricing is subject to change.

ECHO SRM2620 TRIMMER
Commercial String Trimmer

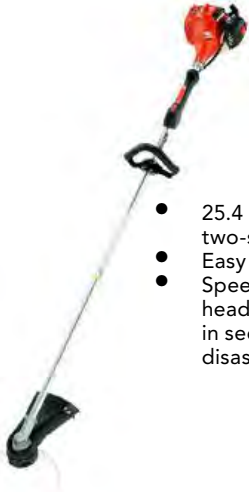

- 25.4 CC professional grade two-stroke engine
- Easy start
- Speed-Feed 400 cutting head that re-loads in seconds without disassembly

ECHSRM-2620AAC 25.4CC PRO TRIMMER

POWER ROTARY SCISSORS
Convert Trimmer to Recipricator



- Convert any brand weedeater into a recipricator at a fraction of the price of buying a complete unit
- Great for edging and trimming
- Prevents scattering
- Available standard 9.5" or 11" diameter
- Impact resistant
- Will attach to any brand string trimmer or brush cutter
- 11" rotary scissors great for bunkers

TLTPRS9.5 9.5" ROTARY SCISSORS

TLTPRS11 11" ROTARY SCISSORS

ECHO PB2620
Hand Held Blower



- 25.4 cc professional-grade, 2-stroke engine
- 191 MPH performance Low noise, 64 dB(A)* output for noise sensitive environments
- Flared pipe for increased air speed

ECHPB2620C

ECHO COMMERCIAL
Gas Backpack Blowers



ECHO PPT2620
Commercial Pole Pruner

- 25.4 CC two-stroke engine
- Adjustable oiler to match cutting conditions
- 12" cutting bar

ECHPPT2620C



PE-225 21.2 CC EDGER
With I-30 Starter

- 21.2 cc professional-grade, 2-stroke engine
- Captive wheel mount hardware for easy wheel height adjustability

ECHPE-225C

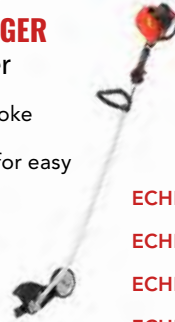

ECHPB-580TAAC

TUBE THROTTLE (58CC)

ECHPB7910HC

HIP THROTTLE (79.9CC)

ECHPB9010TC

TUBE THROTTLE (79.9CC)

ECHPB9010HC

HIP THROTTLE (79.9CC)

ECHO TOP HANDLE CHAINSAWS

- The lightest gas powered chain saw in North America
- 25 cc - 2-stroke engine
- Clutch-driven oiler for reduced oil consumption
- Choke w/ auto fast idle for easy starting
- Dual post chain break for durability
- 12' & 14" cutting bar

ECHCS-2511TN-12C 12" BAR

ECHCS-2511TN-14C 14" BAR



ECHO GAS SERIES CHAINSAWS

- 50.2 cc professional-grade, 2-stroke engine
- Adjustable clutch-driven oiler - reduces oil consumption
- Decompression valve - for easier starting
- Professional-grade bar and chain for superior cutting performance

ECHCS4010-18C 18" BAR

PRO GARD 2 CYCLE OIL

- Case of 24 - 2.6 ounce bottles (each bottle makes 1 gallon of mixed fuel at 50:1 ratio)
- Case of 12 - 12.8 ounce bottles (each bottle makes 5 gallons of mixed fuel at 50:1 ratio)
- 5 Gallon Pail
- 2.6 ounces makes one gallon of two cycle oil mix at the recommended 50:1 ratio

SHPOIL12 12.8 OZ- CASE OF 12

SHPOIL26 2.6 OZ- CASE OF 24

SHPOIL5P 5 GALLON PAIL



ECHO HCS-2810C
20" Double-Sided Hedge Trimmer

- Full-length debris shield for reduced cleanup
- RazorEdge™ 3-sided teeth for longer cutting performance
- 1.4 lbs. lighter than most competitors
- Vibration reducing features for operator comfort



ECHHCS-2810C

200 POWER EQUIPMENT

NEW PRODUCT!



2.5AH LITHIUM-ION BATTERY



ECHLBP-56V125A

5.0AH LITHIUM-ION BATTERY



ECHLBP-56V250A

8.0AH LITHIUM-ION BATTERY



ECHLBP-56V400A

STANDARD CHARGER



ECHLC-56V2AAB

RAPID CHARGER



ECHLC-56V4AAB

DUAL PORT RAPID CHARGER



ECHLC-56V5A2AB

TOP MOUNT CHARGER

ECHLC-56V1AACC



BATTERY POWERED BACKPACK BLOWER

DPB-5800T



ECHDPB-5800BT

BACKPACK BLOWER ONLY

ECHDPB-5800TD2-2

UNIT + (2) 5.0AH BATTERIES & DUAL PORT CHARGER

549 CFM BATTERY POWERED HANDHELD BLOWER

DPB-2500



ECHDPB-2500BT

HANDHELD BLOWER ONLY

ECHDPB-2500C1

UNIT + 2.5AH BATTERY & STANDARD CHARGER

ECHDPB-2500R2

UNIT + 5.0AH BATTERY & RAPID CHARGER

TELESCOPING SHAFT POWER PRUNER

DPPT-2600H



ECHDPPT-2600HBT

PRUNER UNIT ONLY

ECHDPPT-2600HR2

UNIT + 5.0AH BATTERY & RAPID CHARGER

56V FIXED SHAFT POWER PRUNER

DPPF-2100



ECHDPPF-2100BT

PRUNER UNIT ONLY

ECHDPPF-2100C1

UNIT + 2.5AH BATTERY & STANDARD CHARGER

Check out Justrite's Lithium-Ion Battery Charging Storage Cabinet in the Maintenance Shop Supplies section!

22" DOUBLE SIDED BATTERY POWERED HEDGE TRIMMER

DHC-2300



ECHDHC-2300BT

HEDGE TRIMMER UNIT ONLY

ECHDHC-2300C1

UNIT + 2.5AH BATTERY & STANDARD CHARGER

22" DOUBLE-SIDED HEDGE TRIMMER

DHC-2200



ECHDHC-2200BT

HEDGE TRIMMER UNIT ONLY

ECHDHC-2200R1

UNIT + 2.5AH BATTERY & RAPID CHARGER

34" SINGLE-SIDED HEDGE TRIMMER

DHCS-3400



ECHDHCS-3400BT

HEDGE TRIMMER UNIT ONLY

ECHDHCS-3400R1

UNIT + 2.5AH BATTERY & RAPID CHARGER

17 IN. BATTERY POWERED STRAIGHT SHAFT STRING TRIMMER

DSRM-2600



ECHDSRM-2600BT

STRING TRIMMER UNIT ONLY

ECHDSRM-2600R2

UNIT + 5.0AH BATTERY & RAPID CHARGER

17 IN. BATTERY POWERED U-SHAPED HANDLE STRING TRIMMER

DSRM-2600U



ECHDSRM-2600UBT

STRING TRIMMER UNIT ONLY

ECHDSRM-2600UR2

UNIT + 5.0AH BATTERY & RAPID CHARGER

CURVED SHAFT EDGER

DPE-2600



ECHDPE-2600BT

EDGER UNIT ONLY

ECHDPE-2600R2

UNIT + 5.0AH BATTERY & RAPID CHARGER

BATTERY POWERED PRO ATTACHMENT SYSTEM

DPAS-2100SB



ECHDPAS-2100SBBT

PAS UNIT ONLY

ECHDPAS-2100SBC1

UNIT + 2.5AH BATTERY & STANDARD CHARGER

Pricing is subject to change.



56V 18" BATTERY REAR-HANDLE CHAINSAW
DCS-5000



ECHDCS-5000-18BT CHAINSAW ONLY
ECHDCS-5000-18C2 UNIT + 5.0AH BATTERY & STANDARD CHARGER

56V BATTERY TOP HANDLE CHAINSAW
DCS-2500T



ECHDCS-2500T-12BT CHAINSAW ONLY
ECHDCS-2500T-12C1 UNIT + 2.5AH BATTERY & STANDARD CHARGER
ECHDCS-2500T-12R1 UNIT + 2.5AH BATTERY & RAPID CHARGER

2.5AH LITHIUM-ION BATTERY



ECHLBP-56V125A

5.0AH LITHIUM-ION BATTERY



ECHLBP-56V250A

8.0AH LITHIUM-ION BATTERY



ECHLBP-56V400A

STANDARD CHARGER



ECHLC-56V2AAB

RAPID CHARGER



ECHLC-56V4AAB

DUAL PORT RAPID CHARGER



ECHLC-56V5A2AB

TOP MOUNT CHARGER



ECHLC-56V1AAC

56V BATTERY TOP HANDLE 12" CHAINSAW
DCS-2500TN



ECHDCS-2500TN-12BT CHAINSAW ONLY
ECHDCS-2500TN-12R1 UNIT + 2.5AH BATTERY & RAPID CHARGER

TRIMMER AND BLOWER COMBO KIT

DCP-BVRV51B



ECHDCP-BVRV51B COMBO KIT

BATTERY POWERED 21" PUSH LAWN MOWER

DLM-2100



ECHDLM-2100BT LAWN MOWER ONLY
ECHDLM-2100C2 UNIT + 5.0AH BATTERY & RAPID CHARGER

BATTERY POWERED 21" SELF-PROPELLED 3-IN-1 MOWER

DLM-2100SP



ECHDLM-2100SPBT LAWN MOWER ONLY
ECHDLM-2100SPC2 UNIT + 5.0AH BATTERY & RAPID CHARGER

TRANSPORTER TRAILER

Lowers & Tilts To The Ground For Easy Loading & Unloading

The Transporter lowers to ground level for easy loading of low-clearance equipment like aerators, greens mowers, and golf carts. Features a manual winch for raising and lowering or an optional electric winch, allowing one person to load disabled equipment effortlessly.



- Overall Length - 16'
- Wheel Base - 87"
- Ground Clearance to Bottom of Bed - 10"
- Bed Length - 100" Bed
- Bed Width - 55.5"
- Tires - 205/75-R14

TPTR-1 TRANSPORT TRAILER
TPTR-1-EW ELECTRIC WINCH ADD-ON



BROYHILL SILHOUETTE I GREEN MOWER TRAILER

42" W X 32" L X 9"H
Can Carry One Mower



BROI-2628A-1

BROYHILL SILHOUETTE II GREEN MOWER TRAILER

48" W X 61" L X 9"H
Can Carry Two Mowers



BROI-2628A-2

202 EQUIPMENT PARTS

EDGER BLADES



- 1 - SHP2670 1/2" HOLE X 10" BLADE UNSHARPENED
- 2 - SHP2673 1/2" HOLE X 10" BLADE SHARPENED
- 3 - SHP2663 1" HOLE X 8" LONG STICK EDGER BLADE
- 4 - SHP2658 4 STAR 1/2" HOLE EDGER BLADE

TRIMMER LINE

5 LB. Spools

- SHPTLR095 .095 ROUND RED
- SHPTLR105 .105 ROUND RED
- SHPTLR130 .130 ROUND RED
- SHPTLR155 .155 ROUND RED
- SHPTLS095 .095 DIAMOND ORANGE
- SHPTLS105 .105 DIAMOND ORANGE
- SHPTLS130 .130 DIAMOND ORANGE
- SHPTLV095 .095 VORTEX BLACK
- SHPTLV105 .105 VORTEX BLACK
- SHPTLV130 .130 VORTEX BLACK



Round Vortex Diamond

BUMP & FEED UNIVERSAL REPLACEMENT HEAD



- SHP10231 FITS MOST TRIMMERS
- SHP10638 FITS STIHL TRIMMERS

MANUAL UNIVERSAL REPLACEMENT HEAD



SHP9383

KWIK LOAD REPLACEMENT HEAD



- SHPKL730 3 STRING HEAD
- SHPKL650 2 STRING HEAD

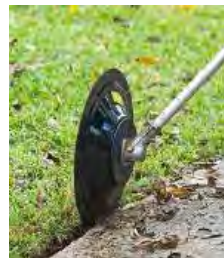

EDGIT PRO TRIMMING GUIDE

- EDG1001 ECHO TRIMMERS
- EDG1006 SHINDAIWA TRIMMERS
- EDG1027 STIHL TRIMMERS
- EDG1028 REDMAX TRIMMERS

BRUSH CUTTER BLADES



10" X 1" - 8 TOOTH

SHP4279



10" X 1" - 80 TOOTH

SHP4278



10" X 1" - 3 TOOTH

SHP4413

TRIMMER LINE CUTTER



SHP12820

- No need to have wire cutters for every crew member
- Simple to use and safe with no exposed cutting edges
- Put on your key ring and have ready when it is time to refill your trimmer

Pricing is subject to change.

CHAMPION SPARK PLUGS



- Champion CJ8
- Shop pack is 24 plugs

SHP2504 4-PACK

SHP2529 SHOP PACK



- Champion RV17YC

SHP8073 4-PACK

NGK SPARK PLUGS



- NGK BPR5ES

SHP2538 4-PACK



- NGK BKR5E
- Shop pack is 100 plugs

SHP9872 4-PACK

SHP11648 SHOP PACK



- NGK CMR7H

SHP10188 10-PACK



- NGK BPM8Y

SHP10020 10-PACK

STONE FUEL FILTER
For Trimmers & Blowers

- Fits most trimmers and small equipment

SHP9024 SMALL

SHP9025 LARGE



FUEL SURGE PUMP PRIMER BULBS



SHP9478 SMALL
(TRIMMERS & BLOWERS)

SHP9948 LARGE (CHAINSAWS)

LARGE FUEL IN-LINE FILTER



SHPGF

STARTER ROPE
100' Roll



SHP9341 #4 ROPE

SHP9343 #5 ROPE

SHP9344 #5.5 ROPE

SHP9345 #6 ROPE

SPRING LOADED BALL JOINTS

- Use to connect reels or rollers to each other
- Spring loaded quick connect fittings
- Made to exceed oem specifications

SHP99-1460 FEMALE

SHP94-2958 MALE STUD



MOWER ROTARY BLADES

Our full line of mower blades cover everything from walk behind mowers to large rough units. Order based off of OEM part number, machine type or measurements.

STANDARD LIFT BLADES



MULCHING BLADES



PAR WEST PART #	OEM PART #	LENGTH	ARBOR	BLADE TYPE	MACHINE	
ORE96-811	GC00344	20 3/4"	3/8"	MULCHING	JOHN DEERE 8800, 3425 SERIES	JOHN DEERE ROTARY MOWERS
ORE396-710	M144935	21 7/8"	7/8"	MULCHING	JOHN DEERE	
ORE396-743	TCU15882	24 15/16"	7/8"	MULCHING	JOHN DEERE 1453	
ORE396-770	M142514	24 7/8"	7/8"	MULCHING	JOHN DEERE 1453	
ORE396-770	TCU14939	17 1/16"	7/8"	MULCHING	JOHN DEERE 48"	
ORE91-079	TCU14939	17 1/16"	7/8"	STANDARD	JOHN DEERE 48"	
ORE596-769	M136195	19 1/16"	7/8"	MULCHING	JOHN DEERE 54"	
ORE96-741	107-0235	26 15/16"	1/2"	MULCHING	TORO 3500D/4000D/4500D/4700D	TORO ROTARY MOWERS
ORE94-045	92-5608-03	21 11/16"	1/2"	STANDARD	TORO 4000D/4100D/4110D	
ORE96-708	107-0214-03	21 11/16"	1/2"	MULCHING	TORO 4000D/4100D/4110D	
ORE96-701	106-7166	19	1/2"	MULCHING	TORO 455D	
ORE94-011	29-5530	25"	3/4"	STANDARD	TORO 72" LEFT HAND CUT GROUNDMASTER	
ORE94-074	110-0621-03	24.5"	1/2"	STANDARD	TORO GROUNDMASTER 3280- 3320	
ORE96-802	110-5948-03	20"	1/2"	MULCHING	TORO GROUNDMASTER 5900/5910	
ORE94-071	110-0624-03	24.5"	1/2"	MULCHING	TORO GROUNDMASTER 3280D - 72" CUT	
ORE396-764	105-7711-03	24.5"	5/8"	MULCHING	TORO TURBO FORCE DECK - 72" CUT	
ORE396-726	390665	18"	5/8"	MULCHING	JACOBSEN 52" CUT FOR RAN- SOMES	JACOBSEN ROTARY MOWERS
ORE396-702	112243-03	21"	5/8"	MULCHING	JACOBSEN AR-5	
ORE93-025	112111-04	24 15/16"	5/8"	STANDARD	JACOBSEN BOBCAT	
ORE396-731	42139B/P848	25"	5/8"	MULCHING	JACOBSEN BOBCAT/ LASTEC	
ORE96-696	JT391039	23"	1/2"	MULCHING	JACOBSEN HR 5111 (LEFT HAND)	
ORE96-795	JT391040	23"	1/2"	MULCHING	JACOBSEN HR 5111 (RIGHT HAND)	
ORE92-013	3007759	20 13/16"	1/2"	STANDARD	JACOBSEN HR 9016	
ORE93-013	112243-03	21"	5/8"	STANDARD	JACOBSEN HR 6010/ TURFCAT 628D	

Don't see the blade you're looking for? We have dozens more - call us for more options!

Pricing is subject to change.

The Ultra Blade is engineered for the professional turfgrass manager who is serious about achieving the highest quality of cut possible with a rotary mower.

ULTRA BLADES CAN BE MANUFACTURED TO FIT MOST ROTARY MOWERS!

ULTRA BLADE

NEW PRODUCT!

Ultra Premium Rotary Mower Blades

- Manufactured from high chrome / nickel alloy
- Specifically heat treated and polished for maximum performance and longevity
- When re-sharpening is necessary, just one to two passes along the cutting edge restores the blade to its original razor sharp edge
- **NOTE- Add OEM part # for your blade choice**



TP-"OEM#"-U

MAGNA-MATIC ROTARY BLADE SHARPENING SYSTEMS



8100 SERIES PROFESSIONAL WORKSTATION

System 1



MAG-8100 Sharpener
MAG-1000 Blade Balancer
MAG-10400 Service Center Stand
Instruction Manual

SHPMAG-SYSTEM1

8100 SERIES PROFESSIONAL WORKSTATION

System 2



MAG-8100 Sharpener
MAG-1000 Blade Balancer
MAG-10400 Service Center Stand
MAG-200 Dust Collector (with stand bracket kit)
Instruction Manual

SHPMAG-SYSTEM2

8200M SERIES PROFESSIONAL WORKSTATION

SYSTEM 4



MAG-8200M Blade Sharpener
MAG-1000 Blade Balancer
MAG-10400 Service Center Stand
Instruction Manual

SHPMAG-SYSTEM4

8200M SERIES PROFESSIONAL WORKSTATION

SYSTEM 5



MAG-8200M Blade Sharpener
MAG-1000 Blade Balancer
MAG-10400 Service Center Stand
MAG-200 Dust Collector (with stand bracket kit)
Instruction Manual

SHPMAG-SYSTEM5

SHARPENER STAND

Add On To Sharpener



SHPMAG-10400

MAG-8100 LAWN MOWER BLADE SHARPENER, 1/2HP

Rotary Blade Sharpener



SHPMAG-8100

MAG-8200M LAWN MOWER BLADE SHARPENER, 1 HP

Rotary Blade Sharpener



SHPMAG-8200M

NO PORT FOR DUST COLLECTOR

SHPMAG-8200M-DCP

4" PORT FOR DUST COLLECTOR

DUST COLLECTOR

Add On To Sharpener



SHPMAG-200



MAGNA-MATIC ROTARY BLADE BALANCER

SHPMAG-1000

ROTARY BLADE BALANCE



SHPBB

LAPPING COMPOUND



- PHL50** 50 GRIT
- PHL80** 80 GRIT
- PHL100** 100 GRIT
- PHL120** 120 GRIT
- PHL150** 150 GRIT
- PHL180** 180 GRIT
- PHL220** 220 GRIT

- Premixed, 25 pound pail
- Formulated with quality minerals and water soluble gel
- Easily rinsed off with water
- All popular grit sizes - from 50 to 220 also available in dry

SPRING LOADED BALL JOINTS



- Use to connect reels or rollers to each other
- Spring loaded quick connect fittings
- Made to exceed oem specifications

- SHP99-1460** FEMALE
- SHP94-2958** MALE STUD

BACK LAPPING BRUSH



SHPBLB

BACK LAPPING MACHINE



- 1/2 HP reversing motor
- Two adjustable support stands

SHPBL

BEDKNIFE IMPACT DRIVER



- Use with drive bits below
- Converts hammer impacts into 200 ft. lbs. of torque
- Impact helps keep bits in their grooves

SHPID

ANTI SEIZE



SHP11432

IMPACT SCREW BIT FOR BEDKNIVES

- Use with driver above or mount on impact gun
- Specially made to fit Toro, John Deere or Jacobsen bedknife screws

- SHP4S-D101** JOHN DEERE
- SHP4S-T101** TORO
- SHP4S-J101** JACOBSEN GREENS MOWERS
- SHP4S-J102** JACOBSEN FAIRWAY MOWERS



Pricing is subject to change.

ACCU-GAUGE

- Adjustments can be made with the height of cut gauge on the mower. Simply read the gauge while turning the adjusting knob.
- Measurements are made at the front edge of the bedknife regardless of bedknife wear.
- Front and rear roller defects can be measured as well as bedknife defects.
- Fits all makes of Greensmowers, both riders & walkers.
- Works on both grooved and solid rollers.
- Available in dial gauge, digital gauge or metric dial gauge
- Several accessory variations are available

18 INCH MODELS

ACU001-18	DIAL GAUGE - NO EXTRAS
ACU001-18-HF	DIAL W/ HANDS FREE
ACU001-18-GG	DIAL W/ GAUGE GUARD
ACU001-18-GRG	DIAL W/ GRIP GUARD
ACU001-18-HF-GR	DIAL W/ GRIP GUARD & HANDS FREE
ACU001-18D	DIGITAL GAUGE - NO EXTRAS
ACU001-18D-HF	DIGITAL W/ HANDS FREE
ACU001-18D-GG	DIGITAL W/ GAUGE GUARD
ACU001-18D-GRG	DIGITAL W/ GRIP GUARD
ACU001-18D-HF-GR	DIGITAL W/ GRIP GUARD & HANDS FREE

24 INCH MODELS

ACU001-24	DIAL GAUGE - NO EXTRAS
ACU001-24-HF	DIAL W/ HANDS FREE
ACU001-24-GG	DIAL W/ GAUGE GUARD
ACU001-24-GRG	DIAL W/ GRIP GUARD
ACU001-24-HF-GR	DIAL W/ GRIP GUARD & HANDS FREE
ACU001-24D	DIGITAL GAUGE - NO EXTRAS
ACU001-24D-HF	DIGITAL W/ HANDS FREE
ACU001-24D-GG	DIGITAL W/ GAUGE GUARD
ACU001-24D-GRG	DIGITAL W/ GRIP GUARD
ACU001-24D-HF-GR	DIGITAL W/ GRIP GUARD & HANDS FREE



DIAL GAUGE



DIGITAL GAUGE



HANDS FREE



GAUGE GUARD



GRIP GUARD

ALUMINUM CASE FOR ACCU-GAGE



ACU001-AC

GROOMER-GAGE



ACU007	DIAL GAUGE
ACU007D	DIGITAL GAUGE
ACU007-HF	DIAL W/ HANDS FREE
ACU007D-HF	DIGITAL W/ HANDS FREE

- Groomer-Gage is a precision measuring instrument for accurately setting the desired grooming depth of groomer or verticutting units.
- Bar length - 18"
- Easy to use, just set the bar on the front and rear rollers and, with the grooming blades rotated perpendicular to the bar, push the indicating rod up until the indicating block touches the blades. Read Gage for measurement.

BENCH PLATES

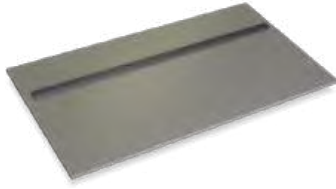

- A useful utility surface plate, with an attached parallel bar for use in setting mower rear rollers parallel with the reel.

ACU006A 20" X 36" BENCH PLATE

ACU006B 18" X 24" BENCH PLATE

ROLLER CHECK



- Easy to use tool for checking the parallelness of rear rollers on Greensmowers

ACURC-II GREENSMOWER - 22"

ACURC-III FAIRWAY MOWER - 30"

ANGLE CHECK



- Check your bedknife attitude with the new ANGLE-CHECK
- Digital and magnetic, the ANGLE-CHECK is the easy way to check your bedknife attitude.

ACU001-AG ANGLE CHECK

BEDKNIFE FACER



- High performance angle grinder with a customized angle attachment to facilitate in front edge bedknife grinding (also called facing)
- Adjustable pin moves the reel in front of the grinding disc
- Makita-Built motor delivers 10,000 RPMS
- Choose standard, variable speed or cordless options

ACUMFG-1A FAST GRIND

ACUMFG-4A VARIABLE SPEED

ACUMFG-2C 18 VOLT CORDLESS

BEDKNIFE BUDDY



- The Bedknife buddy is a quick and easy way to lightly "touch up" Greensmower bedknives
- Unique nylon holding block moves the reel out of the way while the file (replaceable) puts a light clean up edge on the front face of the bedknife.



ACUBB-01 BEDKNIFE BUDDY

ACCUGAUGE II W/ CASE



- The Accu-Gage II is for ease in checking or setting mowers in the field or while units are still attached to mowers.
- (Available in digital only)
- Easy to use. Place under mower with indicator head bedknife and read gage.
- Comes with case

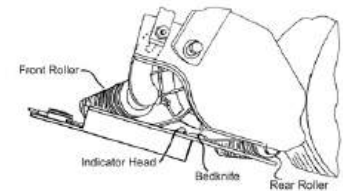

ACU001-IID DIGITAL GAUGE

BEDKNIFE SCREWS



CTI32-4910 TORO BEDKNIFE SCREWS (PACK 100)

CTI30-7194 JOHN DEERE BEDKNIFE SCREWS (PACK 100)

CTI30-5055 JOHN DEERE BEDKNIFE SCREWS W/ NUTS (PACK 25)

CTI31-9138 JACOBSEN BEDKNIFE SCREWS (PACK 100)

PRO EDGE III BEDKNIFE SHARPENER



- Sharpens top face and front edge
- Bed knife held in place with two modified mechanical "C" clamps
- All-electric motor
- Special composite stone grinds without creating excess heat
- Fully automatic (optional)
- All aluminum

TPBS-PE3

PREMIUM BEDKNIVES

DESCRIPTION	PART #	HOLES	MIN. CUT	OEM #	MODELS
18" MICRO CUT	CTI32-261	11	.115"	98-7261	GM1800/FLEX 18/ EFLEX 1800
21" HIGH CUT	CTI32-396	7	.135"	94-6396	GM3000
PHOENIX 13 HOLE SUPER MICRO CUT	CTI32P-261	13	.098"	N/A	
PHOENIX 13 HOLE MICRO CUT 21.5"	CTI32P-262	13	.098"	93-4262	
21" MICRO CUT	CTI32-262	13	.115"	93-4262	
PHOENIX TOURN. 21.5"	CTI32P-263	13	.115"	93-4263	
21" TOURN.	CTI32-263	13	.125"	93-4263	
21" LOW CUT	CTI32-264	13	.135"	93-4264	
26" LOW CUT	CTI32-015	16	.125"	93-9015	GM1600, GM2600
21" FAIRWAY CUT	CTI32-610	7	.250"	63-8610	RM223D, 5100D, 5200D, 5300D, 5400D
21" HIGH CUT HEAVY DUTY	CTI32-350	7	.375"	100-3350	RM223D, 5100D, 5200D, 5300D, 5400D
22" FAIRWAY CUT	CTI32-096	8	.375"	108-9096	RM5210, 5410, 5510, 5610, 5500D, 6500D, 6700D
30" FAIRWAY CUT	CTI32-890	10	.375"	72-0480 59-5890	RM335, 3500D, 450D, 4000D, 4500D
32" LOW CUT	CTI32-079	12	.375"	94-5079	RM216, 2000D, 2300D, 2600D, 3100D
PHOENIX 22" SUPER TOURNAMENT	CTI30P-869	13	.098"	ET4869	
PHOENIX SUPER MICRO	CTI30P-351	13	.098"	MT7351	220 A/B/C/SI walk behind Greensmower, 2243 & 2500 pro Greensmower, 3215a & 3235A lightweight fwy mower, 7500 & 8500 fairway mower
PHOENIX TOURN.	CTI30P-534	13	.115"	ET17534	
22" TOURNAMENT	CTI30-534	13	.115"	ET17534	
22" STANDARD	CTI30-533	13	.125	ET17533	
22" FWY LOW CUT	CTI30-532	13	.135"	ET17532	3215A, 3235A, 3225C, 7700, 8700 fwy mowers
22" FWY HIGH CUT	CTI30-767	13	.275"	ET17767	
22" STANDARD	CTI30-751	9	.375"	ET17751	
26" STANDARD	CTI30-947	15	.125"	MT6947	260B/C WALK BEHIND GREENSMOWERS
26" FAIRWAY	CTI30-946	15	.189"	MT6946	
26" STANDARD FWY	CTI30-752	10	.375"	ET17752	2653 (A)
18" MEDIUM	CTI31-902	11	.250"	4118902	
18" SUPER TOURN.	CTI31-888	11	.125"	5002888	
19" TOURNAMENT	CTI31-476	11	.125"	503476	PGM 19
19" SUPER TOURN.	CTI31-984	11	.115"	2810984	PGM 19
22" PHOENIX SUPER TOURN.	CTI31P-887	13	.098"	5002887	
22" SUPER TOURN.	CTI31-887	13	.115"	5002887	
22" PHOENIX TOURN.	CTI31P-479	13	.115"	53479	
22" TOURNAMENT	CTI31-479	13	.125"	503479	
22" LOW PROFILE	CTI31-478	13	.135"	503478	
22" HIGH PROFILE	CTI31-477	13	.175"	503477	
22" HEAVY SECTION	CTI31-460	13	.325"	503460	FAIRWAY MOWERS

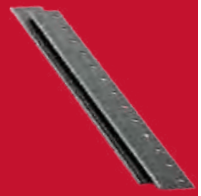

TORO BEDKNIVES



JOHN DEERE BEDKNIVES



JACOBSEN BEDKNIVES



PREMIUM BEDKNIVES

- We source bedKnives that are available in multiple thicknesses and are available to fit major brand Greens, tees and fairway mowers.
- Material: Spring type steel high carbon content, with chrome/nickel alloys. Polish finish.
- Straightness: our bedknives are guaranteed to be perfectly straight without the need for grinding after attaching.
- We are now making a 30 – 40 degree "Manufactured Relief" standard on many of our bedknives.

PART #		DESCRIPTION	
TP-14402	ET14402	JOHN DEERE / 1/8" CUT / STANDARD BEDKNIFE	JOHN DEERE BEDKNIVES
TP-14402-U	ET14402	JOHN DEERE STANDARD 1/8" CUT / ULTRA QUALITY BEDKNIFE	
TP-17532	ET17532	JOHN DEERE / 2500 / MEDIUM DUTY BEDKNIFE	
TP-17533	ET17533	JOHN DEERE / 22" / 13 HOLE / 1/8" CUT STANDARD BEDKNIFE	
TP-17533-U	eT17533	JOHN DEERE / 22" / 13 HOLE / 1/8" / ULTRA QUALITY BEDKNIFE	
TP-17534	ET17534	JOHN DEERE / 22" / 13 HOLE / 1/16" CUT BEDKNIFE	
TP-17534-U	ET17534	JOHN DEERE / 22" / 13 HOLE / 1/16" / ULTRA QUALITY BEDKNIFE	
TP-17751	ET17751	JOHN DEERE / 3215 A / 9 HOLE / HEAVY CUTTING BEDKNIFE	
TP-17752	ET17752	JOHN DEERE / 2653 / 26" BEDKNIFE	
TP-17767	ET17767	JOHN DEERE / 3215 / 13 HOLE / MEDIUM CUTTING BEDKNIFE	
TP-1973	ET1973	JOHN DEERE / 30" / 12 HOLE BEDKNIFE	
TP-476680	47-6680	TORO SPARTAN / LOW CUT / SINGLE LIP BEDKNIFE	TORO BEDKNIVES
TP-497660	49-7660	TORO REEL MASTER / HEAVY CUT BEDKNIFE	
TP-625180	62-5180	TORO GM / 21" / 13 HOLE / 5/16" CUT BEDKNIFE	
TP-638610	63-8610	TORO GM / 21" / 7 HOLE / 1/4" CUT BEDKNIFE	
TP-934262-U	93-4262	TORO GM / 21" / 13 HOLE / MICRO / ULTRA QUALITY BEDKNIFE	
TP-934264	93-4263	TORO GM / 21" / 13 HOLE / 3/32" CUT BEDKNIFE	
TP-934264-U	93-4264	TORO GM / 21" / 13 HOLE / 1/8" CUT /ULTRA QUALITY BEDKNIFE	
TP-945079	94-5079	TORO 2600 / 3100	
TP-946392	94-6392	TORO GM / 21" / 13 HOLE / 3/16" CUT BEDKNIFE	
TP-948936	94-8936	TORO 5500 / 6500	
TP-325163	325163	JACOBSEN FAIRWAY / 1/2" CUT BEDKNIFE	JACOBSEN BEDKNIVES
TP-4128286-U	4128286	JACOBSEN SUPER TOURNAMENT BEDKNIFE	
TP-5003150	5003150	JACOBSEN LIGHTWEIGHT FAIRWAY / LOW CUT BEDKNIFE	
TP-503363	503363	JACOBSEN TRI KING / 30" BEDKNIFE	
TP-503460	503460	JACOBSEN LIGHTWEIGHT FAIRWAY BEDKNIFE	
TP-503477	503477	JACOBSEN / 22" / 3/16" CUT BEDKNIFE	
TP-503478	503478	JACOBSEN / 22" / 1/8" CUT BEDKNIFE	
TP-503478-U	503478	JACOBSEN / 22" / 1/8" CUT / ULTRA QUALITY BEDKNIFE	
TP-503479-U	503479	JACOBSEN / 22" / 3/32" CUT / ULTRA QUALITY BEDKNIFE	

Eclipse 122/122f, pgm22, gk522, e-walk, gkiv, eclipse 322, gkv, gkvi, gp400, g-plexiii

Pricing is subject to change.

PREMIUM REPLACEMENT CUTTING REELS

Toro Mowers

Our reels feature the quality you have come to expect with our tines and bedknives with a price that beats oem parts

- Longer life from quality materials
- No preparation - install and mow
- Superior fit and finish



PART #	OEM #	SIZE	BLADES	FITS MOWERS
CTI32-R6097	93-6097, 127-2182, 132-7313 (EDGE SERIES)	5" X 21"	11 BLADE	GREENSMASER 1000, 1010, AND 2000 INTERGRAL CUTTING UNITS
CTI32-R7635	107-7635, 127-2176	5" X 21"	11 BLADE	GREENSMASER FLEX 21 (2011 AND OLDER)
CTI32-R4289	115-4289, 127-2177	5" X 21"	14 BLADE	GREENSMASER FLEX 21 (2011 AND OLDER)
CTI32-R4104	119-4104, 127-2201, 137-8512 (EDGE SERIES REEL)	5" X 21"	11 BLADE	GREENSMASER FLEX / EFLEX 2100 AND 2120 (2012 AND NEWER)
CTI32-R4105	119-4105, 127-2202, 137-8513 (EDGE SERIES REEL)	5" X 21"	14 BLADE	GREENSMASER FLEX / EFLEX 2100 AND 2120 (2012 AND NEWER)
CTI32-R5792	105-5792, 127-2194	5" X 21"	11 BLADE	GREENSMASER 3000, 3100, AND 3200 DPA CUTTING UNITS (2011 AND OLDER)
CTI32-R0649	14-0649, 130-0093	5" X 21"	8 BLADE	REELMASTER 5200, 5300, AND 5400 4 BOLT CUTTING UNITS
CTI32-R9071	108-9071, 127-2065, 137-8416 (REEL)	5" X 22"	8 BLADE	REELMASTER 5210 AND 5410 DPA CUTTING UNITS
CTI32-R9073	108-9073, 127-2084, 137-8432 (REEL)	7" X 22"	8 BLADE	REELMASTER 5510, 5610, 6500, AND 6700 DPA CUTTING UNITS
CTI32-R9074	108-9074, 127-2085, 137-8433 (REEL)	7" X 22"	11 BLADE	REELMASTER 5510, 5610, 6500, AND 6700 DPA CUTTING UNITS
CTI32-R4337	94-4337, 130-0095, 137-8451 (REEL)	7" X 22"	5 BLADE	REELMASTER 6500 AND 6700 SPA CUTTING UNITS
CTI32-R4338	94-4338, 130-4114, 137-8453	7" X 22"	11 BLADE	REELMASTER 6500 AND 6700 SPA CUTTING UNITS
CTI32-R9276	112-9276, 127-2207	5" X 26"	11 BLADE	GREENSMASER 1600, 1610, AND 2600 INTERGRAL CUTTING UNITS

PREMIUM REPLACEMENT CUTTING REELS

John Deere Mowers

Our reels feature the quality you have come to expect with our tines and bedknives with a price that beats oem parts

- Longer life form quality materials
- No prepration - install and mow
- Superior fit and finish



PART #	OEM #	SIZE	BLADES	FITS MOWERS
CTI30-R2883	AMT2883	5" X 22"	11 BLADE	2243 AND 2500 PROFESSIONAL GREENSMOWER 3215A, 3235A, 7500, AND 8500 LIGHTWEIGHT FAIRWAY MOWER
CTI30-R2885	AMT2885	5" X 22"	11 BLADE	2243 AND 2500 PROFESSIONAL GREENSMOWER 3215A, 3235A, 7500, AND 8500 LIGHTWEIGHT FAIRWAY MOWER
CTI30-R2886	AMT2886	5" X 22"	11 BLADE	180A, 220, 220A WALK-BEHIND GREENSMOWER
CTI30-R9350	TCA19350	5" X 22"	7 BLADE	220 E-CUT WALK-BEHIND GREENSMOWER, 2500B AND 2500E RID-ING GREENSMOWER, 7500 AND 8500 FAIRWAY MOWER



PREMIUM REPLACEMENT CUTTING REELS

John Deere Mowers



PART #	OEM #	SIZE	BLADES	FITS MOWERS
CTI30-R9351	TCA19351	5" X 22"	11 BLADE	220 E-CUT WALK-BEHIND GREENSMOWER, 2500B AND 2500E RIDING GREENSMOWER, 7500 AND 8500 FAIRWAY MOWER
CTI30-R3621	TCA23621	5" X 22"	14 BLADE	220 E-CUT WALK-BEHIND GREENSMOWER, 2500B AND 2500E RIDING GREENSMOWER, 7500 AND 8500 FAIRWAY MOWER
CTI30-R2893	AMT2893	7" X 22"	8 BLADE	3215A/ B, 3225B /C, 3235 A/B/C, 7700, AND 8700 LIGHTWEIGHT FAIRWAY MOWERS
CTI30-R2894	AMT2894	7" X 22"	10 BLADE	3215A/ B, 3225B /C, 3235 A/B/C, 7700, AND 8700 LIGHTWEIGHT FAIRWAY MOWERS
CTI30-R9353	TCA19353	7" X 22"	8 BLADE	7700 AND 8700 FAIRWAY MOWER
CTI30-R9354	TCA19354	7" X 22"	10 BLADE	7700 AND 8700 FAIRWAY MOWER
CTI30-R2871	AMT2871	7" X 26"	8 BLADE	2653, 2653A, AND 2653B PROFESSIONAL UTILITY MOWER
CTI30-R9356	TCA19356	7" X 26"	8 BLADE	2653B AND 7200 TRIM AND SURROUNDS MOWER, 8900A LARGE AREA REEL MOWER

PREMIUM REPLACEMENT CUTTING REELS

Jacobsen Mowers



PART #	OEM #	SIZE	BLADES	FITS MOWERS
CTI31-R3053	5003053	5" X 22"	7 BLADE	ECLIPSE 322, GP400, G-PLEX, AND E-PLEX, LF-128 (LEFT), LF-3400 (LEFT), LF-4675 (LEFT), LF-510 (LEFT), LF-550 (LEFT), AND LF-550H (LEFT)
CTI31-R3054	5003054	5" X 22"	7 BLADE	GK 5 AND GK 6 ELECTRIC, LF-128 (RIGHT), LF3400 (RIGHT), F-4675 (RIGHT), LF-510 (RIGHT), LF-550 (RIGHT), AND LF-550H (RIGHT)
CTI31-R3453	5003453	5" X 22"	11 BLADE	ECLIPSE 322, GP400, G-PLEX, AND E-PLEX, LF-128 (LEFT), LF-3400 (LEFT), LF-4675 (LEFT), LF-510 (LEFT), LF-550 (LEFT), AND LF-550H (LEFT)
CTI31-R3454	5003454	5" X 22"	11 BLADE	GK 5 AND GK 6 ELECTRIC, LF-128 (RIGHT), LF3400 (RIGHT), LF-4675 (RIGHT), LF-510 (RIGHT), LF-550 (RIGHT), AND LF-550H (RIGHT)
CTI31-R0148	5000148	5" X 22"	11 BLADE	GK 500-22"
CTI31-R1101	5001101	5" X 22"	11 BLADE	ECLIPSE 322, ECLIPSE 122F, GK 4 (LEFT), G-PLEX 3, E-PLEX, GP400
CTI31-R1102	5001102	5" X 22"	11 BLADE	GK 4 (RIGHT), GK 5 AND GK 6
CTI31-R3652	5003652	5" X 26"	7 BLADE	GK 500-26"
CTI31-R2087	5002087	7" X 26"	7 BLADE	TR 3 26" (LEFT) AND TRI KING 26" (LEFT)
CTI31-R2088	5002088	7" X 26"	7 BLADE	TR 3 26" (RIGHT) AND TRI KING 26" (RIGHT)

REEL RACK

Can Hold Up To 6 Cutting Units



- Save time and labor costs when storing or transporting reels
- 24" W x 48' L x 66" H
- All steel construction
- Zinc plated
- 800 lb capacity
- Comes complete with casters



TP-RR-1000

POWER EDGE III REEL SHARPENER



- Quick reel set-up, no special tools, just "snap" it in place
- Sharpens reel without need to disassemble reel unit, leave rollers and bed knife in place
- Sharpens most greens, tees, light weight fairway and walk behind professional mowers
- Eliminates "impact" grinding associated with conventional reel grinders
- No stress to reel bearings, seals, shaft and frame
- All Aluminum frame
- All Electric

TP-RS-PE3

Pricing is subject to change.



GOLFCO COMPETITION ROLLERS

Not all rollers are created equal. We believe Golfco competition rollers are the best in the market. Here are the reasons why:



4 SECTION SMOOTH ROLLER



URETHANE SMOOTH ROLLER



URETHANE GROOVED ROLLER



DOUBLE STUBBY ROLLER



STUBBY ROLLER

- Common overhaul kit for all rollers (bearings, seals and retainers are the same). Sealed ball bearings that last without the need for re-greasing
- No need to grease - no grease stains on greens
- Is silent running on all surfaces
- Is very shock absorbing and impact resistant
- Resists debris buildup (superior to any metallic materials)
- Diminishes transmigration of harmful elements such as disease or fungus
- Will not develop frost buildup



GOLFCO ROLLERS

Overhaul Kit - Fits Any Golfco Roller

GOLOHCOMP



GOLFCO ROLLERS

True Turf Greens Rollers

TRU-TURF SMOOTHING HEADS ROLLERS FOR RS48-11E, RB48-11A & TR7000C MACHINES

GOLT2222S25C	2.5" SMOOTH URETHANE CAST OVER HEAVY DUTY STEEL TUBING 22.45"	22.45" BODY TO FIT RS48-11E & RB48-11A
GOLT3939S25C	2.5" SMOOTH URETHANE CAST OVER HEAVY DUTY STEEL TUBING 39.5	39.5" BODY TO FIT GR39
GOLT3939S25C2	2.5" SMOOTH URETHANE CAST OVER HEAVY DUTY STEEL 39.5" 2 BODIES	39.5" BODY TOTAL

TRU-TURF SMOOTHING HEADS ROLLERS FOR R52 MACHINES

GOLT1818S25C	2.5" SMOOTH URETHANE CAST OVER HEAVY DUTY STEEL TUBING 18.45"	18.45" BODY TO FIT R52
---------------------	---	------------------------

ROLLER TAMER

Rebuild True Turf Cutting Unit Rollers

- Allows anyone regardless of skill level to quickly, easily, and properly rebuild cutting unit rollers
- assist with most types of rollers presently and formerly manufactured for the turf industry including water-pump bearing style rollers, tapered roller bearing type, radial ball bearing type, gang mower, basket rollers and others.
- Purchase a Base Unit then add the kit that best suits your needs for make and model of rollers to service.
- All Tamer components are interchangeable between models
- **NOTE- Must buy base unit kit before branded kits**

TP-RT-500 BASE UNIT ROLLER TAMER KIT

TP-RT-504 TRU-TURF PRIMARY KIT

TP-RT-506 *WATER PUMP BEARING PULL KIT



214 EQUIPMENT PARTS



TORO ROTARY DECK ROLLERS

PART #	DIA.	TYPE	FRONT / REAR		OEM NUMBER	MOWERS
GOLT0505G5C	5"	URETHANE SMOOTH	FRONT		104-1092, 115-3412, 115-3418	4500D, 4700D, 3500D & 3505D
GOLT3329A3CG	3"	URETHANE GROOVED	REAR			4500D, 4700D, 3500D & 3505D
GOLT3329A3C	3"	URETHANE SMOOTH	REAR		112-5265	4500D, 4700D, 3500D & 3505D
GOLT3329A3S	3"	STEEL SMOOTH	REAR		112-5265	4500D, 4700D, 3500D & 3505D
GOLT3329A7C	3.5"	URETHANE SMOOTH	REAR			4500D, 4700D, 3500D & 3505D
GOLT0705G5C	5"	URETHANE SMOOTH	FRONT		115-3418, 114-0430	4300D
GOLT2824K3CG	3"	URETHANE GROOVED	REAR			4300D
GOLT2824K3C	3"	URETHANE SMOOTH	REAR		108-7387	4300D
GOLT2824K3S	3"	STEEL SMOOTH	REAR		108-7387	4300D

TORO SIDEWINDER ROLLERS

PART #	DIA.	TYPE	FRONT / REAR		OEM NUMBER	MOWERS
GOLT3026D25CG	2.5"	URETHANE	FRONT & REAR		92-7410, 104-1385	27" 3100D, 27" 2300D & 216
GOLT3026D25C	2.5"	URETHANE SMOOTH	FRONT & REAR		61-0410	27" 3100D, 27" 2300D & 216
GOLT3227D25CG	3"	URETHANE SMOOTH	FRONT & REAR		114-9383	27" 3100D, 27" 2300D & 216
GOLT3227D25C	3"	URETHANE GROOVED	FRONT & REAR		112-8915	27" 3100D, 27" 2300D & 216

ROLLER TAMER

Rebuild Toro Cutting Unit Rollers



- allows anyone regardless of skill level to quickly, easily, and properly rebuild cutting unit rollers
- assist with most types of rollers presently and formerly manufactured for the turf industry including water-pump bearing style rollers, tapered roller bearing type, radial ball bearing type, gang mower, basket rollers and others.
- Purchase a Base Unit then add the kit that best suits your needs for make and model of rollers to service.
- All Tamer components are interchangeable between models
- **NOTE- Must buy base unit kit before branded kits**

TP-RT-500 BASE UNIT ROLLER TAMER KIT



















TP-RT-502 TORO PRIMARY KIT

TP-RT-505 TORO GROUNDMASTER KIT

TP-RT-506 *WATER PUMP BEARING PULL KIT

Pricing is subject to change.

TORO GREEN & TEE MOWERS

PART #	DIA.	TYPE	FRONT/REAR		MOWERS	OEM # OR SPECS
GOLT2522S2C	2"	URETHANE SMOOTH	FRONT		22" MOWERS - SERIES 1000, 3, 300, 3000, 3050, 3100, 3150	52-3170
GOLT2522S2S	2"	STEEL SMOOTH	FRONT		22" MOWERS - SERIES 1000, 3, 300, 3000, 3050, 3100, 3150	52-3200
GOLT2522S25CG	2.5"	URETHANE GROOVED	FRONT		22" MOWERS - SERIES 1000, 3, 300, 3000, 3050, 3100, 3150	22.5" BODY & 25.75" SHAFT
GOLT2522S25C	2.5"	URETHANE SMOOTH	FRONT		22" MOWERS - SERIES 1000, 3, 300, 3000, 3050, 3100, 3150	22.45" BODY & 25.75" SHAFT
GOLT2522A2C	2"	URETHANE SMOOTH	REAR		22" MOWERS - SERIES 1000, 3, 300, 3000, 3050, 3100, 3150	52-3120
GOLT2522A2L	2"	STEEL SMOOTH	REAR		22" MOWERS - SERIES 1000, 3, 300, 3000, 3050, 3100, 3150	52-3120
GOLT2522A25C	2.5"	URETHANE SMOOTH	REAR		22" MOWERS - SERIES 1000, 3, 300, 3000, 3050, 3100, 3150	22.45" BODY & 25.87" SHAFT
GOLT2522A2C	2"	URETHANE SMOOTH	FRONT & REAR		22" TRIFLEX - 3200, 3250, 3300, 3320, 3400, 3420	52-3120
GOLT2522A2L	2"	STEEL SMOOTH	FRONT & REAR		22" TRIFLEX - 3200, 3250, 3300, 3320, 3400, 3420	52-3120
GOLT2522A25CG	2.5"	URETHANE GROOVED	FRONT & REAR		22" TRIFLEX - 3200, 3250, 3300, 3320, 3400, 3420	22.25" BODY & 25.87" SHAFT
GOLT2522A25C	2.5"	URETHANE SMOOTH	FRONT & REAR		22" TRIFLEX - 3200, 3250, 3300, 3320, 3400, 3420	115-7388
GOLT2522A25S	2.5"	STEEL SMOOTH	FRONT & REAR		22" TRIFLEX - 3200, 3250, 3300, 3320, 3400, 3420	115-7388
GOLT2522A2C	2"	URETHANE SMOOTH	FRONT & REAR		FLEX 21 & FLEX 2120	52-3120
GOLT2522A2L	2"	STEEL SMOOTH	FRONT & REAR		FLEX 21 & FLEX 2120	52-3120
GOLT2219S2C	2"	URETHANE SMOOTH	FRONT & REAR		GM800 18"	
GOLT3127A25CG	2.5"	URETHANE GROOVED	FRONT & REAR		GM1600 26"	
GOLT3127A25C	2.5"	URETHANE SMOOTH	FRONT & REAR		GM1600 26"	
GOLT3127A25S	2.5"	STEEL SMOOTH	FRONT & REAR		GM1600 26"	

ROLLER TAMER

Rebuild Toro Cutting Unit Rollers



- allows anyone regardless of skill level to quickly, easily, and properly rebuild cutting unit rollers
- assist with most types of rollers presently and formerly manufactured for the turf industry including water-pump bearing style rollers, tapered roller bearing type, radial ball bearing type, gang mower, basket rollers and others.
- Purchase a Base Unit then add the kit that best suits your needs for make and model of rollers to service.
- All Tamer components are interchangeable between models
- **NOTE- Must buy base unit kit this before branded kits**

TP-RT-500 BASE UNIT ROLLER TAMER KIT

TP-RT-502 TORO PRIMARY KIT

























TP-RT-505 TORO GROUNDSMASTER KIT

TP-RT-506 *WATER PUMP BEARING PULL KIT

PARWEST.COM | 714-893-1555







 **PAR WEST**

TORO FAIRWAY AND ROUGH REEL MOWERS











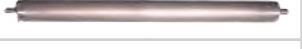

PART #	DIA.	TYPE	FRONT/ REAR		MOWERS	OEM # OR SPECS
GOLT2722A3CG	3"	URETHANE GROOVED	FRONT		5200D, 5210D, 5400D, 5410D, 5510D & 5610D	100-9906
GOLT2722A3C	3"	URETHANE SMOOTH	FRONT		5200D, 5210D, 5400D, 5410D, 5510D & 5610D	99-5749
GOLT2724A3CG	3"	URETHANE GROOVED	FRONT		5200D, 5210D, 5400D, 5410D, 5510D & 5610D	114-5400
GOLT2724A3C	3"	URETHANE SMOOTH	FRONT		5200D, 5210D, 5400D, 5410D, 5510D & 5610D	99-5749
GOLT2522C3C	3"	URETHANE SMOOTH	REAR		5200D, 5210D, 5400D, 5410D, 5510D & 5610D	22.45" BODY & 25.5" SHAFT
GOLT2522C3S	3"	STEEL SMOOTH	REAR		5200D, 5210D, 5400D, 5410D, 5510D & 5610D	22.45" BODY & 25.5" SHAFT
GOLT2522C25C	2.5"	URETHANE SMOOTH	REAR		5200D, 5210D, 5400D, 5410D, 5510D & 5610D	114-5406
GOLT2522C25S	2.5"	STEEL SMOOTH	REAR		5200D, 5210D, 5400D, 5410D, 5510D & 5610D	114-5406
GOLT2321A2C	2"	URETHANE SMOOTH	REAR		5200D, 5210D, 5400D, 5410D, 5510D & 5610D	21.25" BODY & 23.75" SHAFT
GOLT2321A2L	2"	STEEL SMOOTH	REAR		5200D, 5210D, 5400D, 5410D, 5510D & 5610D	21.25" BODY & 23.75" SHAFT
GOLT2319A2C	2"	URETHANE SMOOTH	REAR		5200D, 5210D, 5400D, 5410D, 5510D & 5610D	94-0694
GOLT2319A2S	2"	STEEL SMOOTH	REAR		5200D, 5210D, 5400D, 5410D, 5510D & 5610D	94-0694
GOLT2722A3CG	3"	URETHANE GROOVED	FRONT & REAR		5500D, 6500D & 6700D	100-9906 22.25" BODY & 27" SHAFT
GOLT2722A3C	3"	URETHANE SMOOTH	FRONT & REAR		5500D, 6500D & 6700D	99-5749 22.25" BODY & 27" SHAFT
GOLT2722A3S	3"	STEEL SMOOTH	FRONT & REAR		5500D, 6500D & 6700D	99-5749 22.25" BODY & 27" SHAFT
GOLT2724A3CG	3"	URETHANE GROOVED	FRONT & REAR		5500D, 6500D & 6700D	114-5400 24.25" BODY & 27" SHAFT
GOLT2724A3C	3"	URETHANE SMOOTH	FRONT & REAR		5500D, 6500D & 6700D	99-5749 24.25" BODY & 27" SHAFT
GOLT2724A3S	3"	STEEL SMOOTH	FRONT & REAR		5500D, 6500D & 6700D	99-5749 24.25" BODY & 27" SHAFT
GOLT2522A25CG	2.5"	URETHANE GROOVED	FRONT		5100D, 5300D & 223D	75-1520
GOLT2319A2C	2"	URETHANE SMOOTH	REAR		5100D, 5300D & 223D	94-0694
GOLT2319A2S	2"	STEEL SMOOTH	REAR		5100D, 5300D & 223D	94-0694
GOLT3732K3CG	3"	URETHANE GROOVED	FRONT		4500D, 4300D, 4000D, 3500D, 450D, 335D & 350D	FITS 36" OR 37" SHAFT
GOLT3229T3CG	3"	URETHANE GROOVED	FRONT		4500D, 4300D, 4000D, 3500D, 450D, 335D & 350D	FITS 32" SHAFT
GOLT3429K3C	3"	URETHANE SMOOTH	REAR		4500D, 4300D, 4000D, 3500D, 450D, 335D & 350D	59-5630

Pricing is subject to change.















JOHN DEERE GREEN & TEE MOWERS

PART #	DIA.	TYPE	FRONT/REAR		MOWERS	OEM # OR SPECS
GOLD2119A2CG	2"	URETHANE GROOVED	FRONT		18" 180B & 180C WALKING GREENSMOWERS	
GOLD2119A2C	2"	URETHANE SMOOTH	FRONT		18" 180B & 180C WALKING GREENSMOWERS	
GOLD2522C2CG	2"	URETHANE GROOVED	FRONT & REAR		22" 220 WALKING & 2243 RIDING GREENSMOWERS	22.5" BODY, 25.5" SHAFT
GOLD2522C2C	2"	URETHANE SMOOTH	FRONT & REAR		22" 220 WALKING & 2243 RIDING GREENSMOWERS	22.5" BODY, 25.5" SHAFT
GOLD2522C2CG	2"	URETHANE GROOVED	FRONT & REAR		22" 2500 GREENSMOWER	22.5" BODY, 25.5" SHAFT
GOLD2522C2C	2"	URETHANE SMOOTH	FRONT & REAR		22" 2500 GREENSMOWER	AMT2876
GOLD2926A25CG	2.5"	URETHANE GROOVED	FRONT		260SL WALKING GREENSMOWER	

JOHN DEERE FAIRWAY MOWERS

PART #	DIA.	TYPE	FRONT/REAR		MOWERS	OEM # OR SPECS
GOLD2218A25CG	2.5"	URETHANE GROOVED	FRONT & REAR		18" 8000A PRECISION CUT & E-CUT FAIRWAY	18.0" BODY, 22" SHAFT
GOLD2218A25C	2.5"	URETHANE SMOOTH	FRONT & REAR		18" 8000A PRECISION CUT & E-CUT FAIRWAY	18.0" BODY, 22" SHAFT
GOLD2218A25S	2.5"	STEEL SMOOTH	FRONT & REAR		18" 8000A PRECISION CUT & E-CUT FAIRWAY	18.0" BODY, 22" SHAFT
GOLD2522C2CG	2"	URETHANE GROOVED	FRONT & REAR		22" 3215 & 3225 LIGHT FAIRWAY MOWERS	22.5" BODY, 25.5" SHAFT
GOLD2522C2C	2"	URETHANE SMOOTH	FRONT & REAR		22" 3215 & 3225 LIGHT FAIRWAY MOWERS	AMT2876
GOLD2522C2S	2"	STEEL SMOOTH	FRONT & REAR		22" 3215 & 3225 LIGHT FAIRWAY MOWERS	AMT2876
GOLD2522C3CG	3"	URETHANE GROOVED	FRONT & REAR		22" 3235 LIGHT FAIRWAY MOWER	1 FLAT ON ONE END OF SHAFT
GOLD2522C3C	3"	URETHANE SMOOTH	FRONT & REAR		22" 3235 LIGHT FAIRWAY MOWER	1 FLAT ON ONE END OF SHAFT
GOLD2522C3S	3"	STEEL SMOOTH	FRONT & REAR		22" 3235 LIGHT FAIRWAY MOWER	1 FLAT ON ONE END OF SHAFT
GOLD2522F3CG	3"	URETHANE GROOVED	FRONT & REAR		22" 3235 LIGHT FAIRWAY MOWER	2 FLATS ON ONE END OF SHAFT
GOLD2522F3C	3"	URETHANE SMOOTH	FRONT & REAR		22" 3235 LIGHT FAIRWAY MOWER	2 FLATS ON ONE END OF SHAFT AMT2967
GOLD2522F3S	3"	STEEL SMOOTH	FRONT & REAR		22" 3235 LIGHT FAIRWAY MOWER	2 FLATS ON ONE END OF SHAFT AMT2967

JOHN DEERE FAIRWAY & REEL ROUGH MOWERS

PART #	DIA.	TYPE	FRONT/ REAR		MOWERS	OEM # OR SPECS
GOLD2522F3CG	3"	URETHANE GROOVED	FRONT & REAR		22" 7500/ 8500 & 7700/ 8700 PRECISION CUT & E-CUT	AMT2966, BM25317, BM17668
GOLD2522F3C	3"	URETHANE SMOOTH	FRONT & REAR		22" 7500/ 8500 & 7700/ 8700 PRECISION CUT & E-CUT	22.45" BODY, 25.5" SHAFT - 2 FLATS ON SHAFT
GOLD2522F3S	3"	STEEL SMOOTH	FRONT & REAR		22" 7500/ 8500 & 7700/ 8700 PRECISION CUT & E-CUT	22.45" BODY, 25.5" SHAFT - 2 FLATS ON SHAFT
GOLD2522F2CG	2"	URETHANE GROOVED	FRONT & REAR		22" 7500/ 8500 & 7700/ 8700 PRECISION CUT & E-CUT	22.5" BODY, 25.5" SHAFT 2 FLATS ON SHAFT
GOLD2522F2C	2"	URETHANE SMOOTH	FRONT & REAR		22" 7500/ 8500 & 7700/ 8700 PRECISION CUT & E-CUT	22.5" BODY, 25.5" SHAFT 2 FLATS ON SHAFT
GOLD2522F2S	2"	STEEL SMOOTH	FRONT & REAR		22" 7500/ 8500 & 7700/ 8700 PRECISION CUT & E-CUT	22.5" BODY, 25.5" SHAFT 2 FLATS ON SHAFT
GOLD2522C3CG	3"	URETHANE GROOVED	FRONT & REAR		22" 7500/ 8500 & 7700/ 8700 PRECISION CUT & E-CUT	22.25" BODY, 25.5" SHAFT 1 FLAT ON SHAFT
GOLD2522C3C	3"	URETHANE SMOOTH	FRONT & REAR		22" 7500/ 8500 & 7700/ 8700 PRECISION CUT & E-CUT	22.25" BODY, 25.5" SHAFT 1 FLAT ON SHAFT
GOLD2522C3S	3"	STEEL SMOOTH	FRONT & REAR		22" 7500/ 8500 & 7700/ 8700 PRECISION CUT & E-CUT	22.25" BODY, 25.5" SHAFT 1 FLAT ON SHAFT
GOLD2522C2CG	2"	URETHANE GROOVED	FRONT & REAR		22" 7500/ 8500 & 7700/ 8700 PRECISION CUT & E-CUT	22.25" BODY, 25.5" SHAFT 1 FLAT ON SHAFT
GOLD2522C2C	2"	URETHANE SMOOTH	FRONT & REAR		22" 7500/ 8500 & 7700/ 8700 PRECISION CUT & E-CUT	22.25" BODY, 25.5" SHAFT 1 FLAT ON SHAFT
GOLD2522C2L	2"	STEEL SMOOTH	FRONT & REAR		22" 7500/ 8500 & 7700/ 8700 PRECISION CUT & E-CUT	22.25" BODY, 25.5" SHAFT 1 FLAT ON SHAFT
GOLD3229X3CG	3"	URETHANE GROOVED	FRONT & REAR		30" FAIRWAY (305, 303, 756 & 856)	32.25" SHAFT WITH .5" DIA. ENDS
GOLD3229X3C	3"	URETHANE SMOOTH	FRONT & REAR		30" FAIRWAY (305, 303, 756 & 856)	32.25" SHAFT WITH .5" DIA. ENDS
GOLD3229X3S	3"	STEEL SMOOTH	FRONT & REAR		30" FAIRWAY (305, 303, 756 & 856)	32.25" SHAFT WITH .5" DIA. ENDS

ROLLER TAMER

Rebuild John Deere Cutting Unit Rollers



- allows anyone regardless of skill level to quickly, easily, and properly rebuild cutting unit rollers
- assist with most types of rollers presently and formerly manufactured for the turf industry including water-pump bearing style rollers, tapered roller bearing type, radial ball bearing type, gang mower, basket rollers and others.
- Purchase a Base Unit then add the kit that best suits your needs for make and model of rollers to service.
- All Tamer components are interchangeable between models
- **NOTE- Must buy base unit kit before branded kits**

TP-RT-500 BASE UNIT ROLLER TAMER KIT







TP-RT-503 JOHN DEERE PRIMARY KIT

TP-RT-504 TRU-TURF PRIMARY KIT







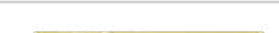

TP-RT-506 *WATER PUMP BEARING PULL KIT

Pricing is subject to change.

JOHN DEERE ROTARY DECK ROLLERS

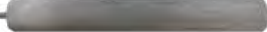













PART #	DIA.	TYPE	FRONT / REAR		OEM NUMBER	MOWERS
GOLD2926C3CG	3"	URETHANE GROOVED	REAR			9009 7400A (2016+)
GOLD2926C3C	3"	URETHANE SMOOTH	REAR		TCA17790	9009 7400A (2016+)
GOLD2926C3S	3"	STEEL SMOOTH	REAR			9009 7400A (2016+)
GOLD0404G5C	5"	URETHANE SMOOTH	FRONT		TCA19047, 19H3185 U44915	7400 (PRE 2016)
GOLD2925A3C	3"	URETHANE SMOOTH	REAR		TCA17790 (3") TCA25970	7400 (PRE 2016)
GOLD2925A3S	3"	STEEL SMOOTH	REAR		TCA17790 (3") TCA25970	7400 (PRE 2016)
GOLD2522C3C	3"	URETHANE SMOOTH	REAR			2653 - 22"
GOLD3229N3C	3"	URETHANE SMOOTH	REAR			2653 - 30"

JACOBSEN ROTARY DECK ROLLERS







PART #	DIA.	TYPE	FRONT / REAR		OEM NUMBER	MOWERS
GOLJ0404G5C	5"	URETHANE SMOOTH	FRONT			AR-522, AR-722,
GOLJ2926R3C	3"	URETHANE SMOOTH	REAR		4163121, 4124015	AR-522, AR-722, AR-5
GOLJ3004D3CT	3"	URETHANE SMOOTH	REAR			AR-5
GOLJ3404R3CT	3"	URETHANE SMOOTH	REAR			AR-3
GOLJ3429R3S	3"	STEEL SMOOTH	REAR		4163083, 4129612, 4163181	AR-3
GOLJ3429R3C	3"	URETHANE SMOOTH	REAR		4163083, 4129612, 4163181	AR-3
GOLR2722X4C	3"	URETHANE SMOOTH	REAR		4115430, 2206195	AR-250, AR-2500
GOLR2722X4S	3"	STEEL SMOOTH	REAR		4115430, 2206195	AR-250, AR-2500

Although we have listed many of our most popular rollers here, there are dozens of other models. Please check our website or call us.

JACOBSEN GREENS & TEE MOWERS



















PART #	DIA.	TYPE	FRONT/REAR		MOWERS	OEM # OR SPECS
GOLJ2522A2CG	2"	URETHANE GROOVED	FRONT		22" GK, GM, E-PLEX, G-PLEX & ECLIPSE 122 & 322	68527
GOLJ2522A2C	2"	URETHANE SMOOTH	FRONT		22" GK, GM, E-PLEX, G-PLEX & ECLIPSE 122 & 322	68641
GOLJ2522A25CG	2.5"	URETHANE GROOVED	FRONT		22" GK, GM, E-PLEX, G-PLEX & ECLIPSE 122 & 322	22.25" BODY & 25.87" SHAFT
GOLJ2522A25C	2.5"	URETHANE SMOOTH	FRONT		22" GK, GM, E-PLEX, G-PLEX & ECLIPSE 122 & 322	22.45" BODY & 25.87" SHAFT
GOLJ2422S2L	2"	STEEL SMOOTH	REAR		22" GK, GM, E-PLEX, G-PLEX & ECLIPSE 122 & 322	1004990
GOLJ2422S2C	2"	URETHANE SMOOTH	REAR		22" GK, GM, E-PLEX, G-PLEX & ECLIPSE 122 & 322	3/8"-24 TAPS IN SHAFT ENDS
GOLJ2422G2L	2"	STEEL SMOOTH	REAR		22" GK, GM, E-PLEX, G-PLEX & ECLIPSE 122 & 322	7/16"-20 TAPS IN SHAFT ENDS
GOLJ2422G2C	2"	URETHANE SMOOTH	REAR		22" GK, GM, E-PLEX, G-PLEX & ECLIPSE 122 & 322	7/16"-20 TAPS IN SHAFT ENDS
GOLJ2119A2CG	2"	URETHANE GROOVED	FRONT & REAR		ALL 18" GREENSMOWERS ECLIPSE 118, GK 418 & GK 518	68616, 63318
GOLJ2119A2C	2"	URETHANE SMOOTH	FRONT & REAR		ALL 18" GREENSMOWERS ECLIPSE 118, GK 418 & GK 518	68626, 4108920, 4175221
GOLJ2119A2L	2"	STEEL SMOOTH	FRONT & REAR		ALL 18" GREENSMOWERS ECLIPSE 118, GK 418 & GK 518	4108920, 4175221
GOLJ2119S2CG	2"	URETHANE GROOVED	FRONT & REAR		18" ECLIPSE2 118F	
GOLJ2119S2C	2"	URETHANE SMOOTH	FRONT & REAR		18" ECLIPSE2 118F	4175221 BODY + 4175220 SHAFT
GOLJ2119S2L	2"	STEEL SMOOTH	FRONT & REAR		18" ECLIPSE2 118F	4175221 BODY + 4175220 SHAFT

JACOBSEN TRI-KING TRIM MOWERS

PART #	DIA.	TYPE	FRONT/REAR		MOWERS	OEM # OR SPECS
GOLJ3229A25CG	2.5"	URETHANE GROOVED	FRONT & REAR		30" TRIKING 1684D & 1900D	
GOLJ3229A25C	2.5"	URETHANE SMOOTH	FRONT & REAR		30" TRIKING 1684D & 1900D	132640
GOLJ3229A25S	2.5"	STEEL SMOOTH	FRONT & REAR		30" TRIKING 1684D & 1900D	132640
GOLJ3229A3CG	3"	URETHANE GROOVED	FRONT & REAR		30" TRIKING 1684D & 1900D	67729 (SET OF 3)
GOLJ3229A3C	3"	URETHANE SMOOTH	FRONT & REAR		30" TRIKING 1684D & 1900D	
GOLJ3229A3S	3"	STEEL SMOOTH	FRONT & REAR		30" TRIKING 1684D & 1900D	

Pricing is subject to change.

JACOBSEN FAIRWAY MOWERS

PART #	DIA.	TYPE	FRONT/ REAR		MOWERS	OEM # OR SPECS
GOLJ2522A3CG	3"	URETHANE GROOVED	FRONT		ALL LF MODELS EXCEPT 26" 2500, 3050 & 3810	123268
GOLJ2522A3C	3"	URETHANE SMOOTH	FRONT		ALL LF MODELS EXCEPT 26" 2500, 3050 & 3810	
GOLJ2422S2C	2"	URETHANE SMOOTH	REAR		ALL LF MODELS EXCEPT 26" 2500, 3050 & 3810	22.25" BODY & 3/8"-24 TAPS IN SHAFT ENDS
GOLJ2422S2S	2"	STEEL SMOOTH	REAR		ALL LF MODELS EXCEPT 26" 2500, 3050 & 3810	1000770
GOLJ2422S2L	2"	STEEL SMOOTH	REAR		ALL LF MODELS EXCEPT 26" 2500, 3050 & 3810	1004990 LIGHT TUBING
GOLJ2421S25C	2.5"	URETHANE SMOOTH	REAR		ALL LF MODELS EXCEPT 26" 2500, 3050 & 3810	5003687, 1003728, 1002446, 100105
GOLJ2421S25S	2.5"	STEEL SMOOTH	REAR		ALL LF MODELS EXCEPT 26" 2500, 3050 & 3810	5003687, 1003728, 1002446, 100105
GOLJ2422G2C	2"	URETHANE SMOOTH	REAR		ALL LF MODELS EXCEPT 26" 2500, 3050 & 3810	22.25" BODY & 7/16"-20 TAPS IN SHAFT ENDS
GOLJ2422G2S	2"	STEEL SMOOTH	REAR		ALL LF MODELS EXCEPT 26" 2500, 3050 & 3810	1000770
GOLJ2422G2L	2"	STEEL SMOOTH	REAR		ALL LF MODELS EXCEPT 26" 2500, 3050 & 3810	1004990 LIGHT TUBING
GOLJ2421G25C	2.5"	URETHANE SMOOTH	REAR		ALL LF MODELS EXCEPT 26" 2500, 3050 & 3810	5003687, 1003728, 1002446, 100105
GOLJ2421G25S	2.5"	STEEL SMOOTH	REAR		ALL LF MODELS EXCEPT 26" 2500, 3050 & 3810	5003687, 1003728, 1002446, 100105
GOLJ2419S2C	2"	URETHANE SMOOTH	REAR		ALL LF MODELS EXCEPT 26" 2500, 3050 & 3810	19.25" BODY & 3/8"-24 TAPS IN SHAFT ENDS
GOLJ2419S2S	2"	STEEL SMOOTH	REAR		ALL LF MODELS EXCEPT 26" 2500, 3050 & 3810	19.25" BODY & 3/8"-24 TAPS IN SHAFT ENDS
GOLJ3026X3CG	3"	URETHANE GROOVED	FRONT & REAR		LF 2500 & LF 3050	1/2" DIA. SHAFT ENDS
GOLJ3026X3C	3"	URETHANE SMOOTH	FRONT & REAR		LF 2500 & LF 3050	1/2" DIA. SHAFT ENDS
GOLJ2016G2C	2"	URETHANE SMOOTH	REAR		18" LIGHT FAIRWAY SLF1880	68674, 4115860
GOLJ2019S2C	2"	URETHANE SMOOTH	REAR		18" LIGHT FAIRWAY SLF1880	4135083
GOLJ2019S25C	2.5"	URETHANE SMOOTH	REAR		18" LIGHT FAIRWAY SLF1880	4135083

ROLLER TAMER

Rebuild Jacobsen Cutting Unit Rollers



- allows anyone regardless of skill level to quickly, easily, and properly rebuild cutting unit rollers
- assist with most types of rollers presently and formerly manufactured for the turf industry including water-pump bearing style rollers, tapered roller bearing type, radial ball bearing type, gang mower, basket rollers and others.
- Purchase a Base Unit then add the kit that best suits your needs for make and model of rollers to service.
- All Tamer components are interchangeable between models
- **NOTE- Must buy base unit kit before branded kits**

- TP-RT-500 BASE UNIT ROLLER TAMER KIT
 TP-RT-501 JACOBSEN PRIMARY KIT
 TP-RT-504 TRU-TURF PRIMARY KIT
 TP-RT-506 *WATER PUMP BEARING PULL KIT

222 EQUIPMENT PARTS



TURF SAVER®

With its classic square shouldered design, Turf Saver is the market leader for riding mowers. The flat profile and chevron tread provide excellent traction. The Turf-friendly design and breadth of line makes the Turf Saver tire versatile.



INDUSTRIAL TIRES



- Radial Trail® HD - Radial Trailer tire offers increased tire life.
- Sport Trail® - Bias construction with a Radial look.
- Sport Trail LH - Perfect for boat, cargo, horse and stock, utility and specialty Trailers.
- USA Trail - Complete line of bias products for applications requiring durable performance

PART #	BRAND	SIZE	PLY
TIR5110251	CARLSTAR	410-4	2
TIRDS7011	DEESTONE	4.10/3.5-4	4
TIR5110271	CARLSTAR	11 X 4.00 - 4	2
TIRDS7012	DEESTONE	11 X 4.00 - 4	4
TIR5110111	CARLSTAR	9 X 3.50 - 4	4
TIR5110101	CARLSTAR	11 X 4.00 - 4	2
TIR5110211	CARLSTAR	13 X 5.00 - 6	4
TIRDS7021	DEESTONE	13 X 5.00 - 6	4
TIR5111861	CARLSTAR	13 X 6.50 - 6	4
TIR5112501	CARLSTAR	15 X 6.00 - 6	4
TIRDS7008	DEESTONE	15 X 6.00 - 6	4
TIR51169900	TRELLEBORG	15 X 6.00 - 6	4
TIR5110951	CARLSTAR	480/400-8	2
TIR5110961	CARLSTAR	480/400-8	4
TIR5112001	CARLSTAR	16 X 6.50 - 8	4
TIRDS7031	DEESTONE	16 X 6.50 - 8	4
TIRDS7035	DEESTONE	16 X 6.50 - 8	4
TIR5110991	CARLSTAR	16 X 7.50 - 8	2
TIR5110991	CARLSTAR	18 X 6.50 - 8	4
TIR5111021	CARLSTAR	18 X 7.50 - 8	4
TIR5110701	CARLSTAR	18 X 8.50 - 8	2
TIR5110711	CARLSTAR	18 X 8.50 - 8	4
TIRDS7039	DEESTONE	18 X 9.50 - 8	4
TIR5110841	CARLSTAR	18 X 9.50 - 8	2
TIR6L05011	CARLSTAR	18 X 9.50 - 8	4
TIR511082	CARLSTAR	18 X 9.50 - 8	6
TIR1004-917	DEESTONE	20 X 10.00 - 10	4
TIR5111161	CARLSTAR	20 X 10.00 - 10	4
TIRDS7043	DEESTONE	20 X 10.00 - 8	4
TIR5111011	CARLSTAR	20 X 10.00 - 8	2
TIR5111111	CARLSTAR	20 X 8.00 - 10	4
TIRDS7041	DEESTONE	20 X 8.00 - 8	4
TIR5110801	CARLSTAR	20 X 8.00 - 8	2
TIR5111140	CARLSTAR	21 X 7.00 - 10	2
TIR5110511	CARLSTAR	22 X 9.50 - 12	2
TIR1214-917	DEESTONE	22 X 10.00 - 10	4
TIR51112	CARLSTAR	23 X 10.50 - 12	2

PART #	BRAND	TIRE SIZE	PLY
TIR560375	CARLSTAR	10-16.5	D
TIR3-50-001-7625	WANDA	10-16.5	E
TIR112260	GALAXY	10-16.5	E
TIR290260	CONST	10-16.5	E
TIR570130	CARLSTAR	10-16.5	E
TIR133260	GALAXY	10-16.5	E
TIR6A0325	CARLSTAR	11L-15	E
TIR544153	GALAXY	11L-15	D
TIR51F3181	CARLSTAR	11L-15	D
TIR231155	GALAXY	12.5/80-18	E
TIR571291	GALAXY	12-16.5	H
TIR3-50-001-7624	WANDA	12-16.5	G
TIR112266	GALAXY	12-16.5	F
TIR290266	CONST	12-16.5	F
TIR133266	GALAXY	12-16.5	F
TIR6A0326	CARLSTAR	14.9-24	G
TIR245426	GALAXY	14.9-24	
TIR200426	GALAXY	14-17.5	F
TIR570077	CARLSTAR	14-17.5	G
TIR6A0327	CARLSTAR	16.9-24	G
TIR6A0363	CARLSTAR	16.9-24	D
TIR200432	GALAXY	16.9-24	F
TIR6A0800	CARLSTAR	16.9-28	F
TIR200546	GALAXY	16.9-28	e
TIR200548	GALAXY	17.5-24	f
TIR6A034	CARLSTAR	17.5-24	d
TIR200434	GALAXY	19.5-24	e
TIRA0667	CARLSTAR	19.5-24	d
TIR200439	GALAXY	19.5-24	f
TIR6A0802	CARLSTAR	25x8.50-14	f
TIR102103	GALAXY	43x16.00-20	c
TIR570059	CARLSTAR	5.70-12	c
TIR111026	GALAXY	9.51L-15	b
TIR544143	GALAXY	9.51L-15	d
TIR51F344	CARLSTAR	9.51L-15	d

Pricing is subject to change.



MULTI-TRAC C/S

The Turf Master / Multi-Trac C/S commercial grade tires feature our most durable tread compound with deep elements in a profile optimized for stability and traction.



PART #	BRAND	SIZE	PLY
TIRP332188508	WANDA	18 X 8.50 - 8	4
TIR5743311	CARLSTAR	18 X 8.50 - 8	4
TIR574365	CARLSTAR	18 X 8.50 - 8	8
TIR574399	CARLSTAR	18 X 9.50 - 10	6
TIRP3322088	WANDA	20 X 8.00 - 8	4
TIR574359	CARLSTAR	20 X 8.00 - 8	2
TIRP332201008	WANDA	20 X 10.00 - 8	4
TIR574341	CARLSTAR	20 X 10.00 - 8	4
TIR5743U11	CARLSTAR	18 X 8.50 - 10	4
TIR5.74E+54	CARLSTAR	18 X 10.50 - 10	4
TIRP33220810	WANDA	20 X 8.00 - 10	6
TIRP332201010	WANDA	20 X 10.00 - 10	4
TIR574362	CARLSTAR	20 X 10.00 - 10	4
TIR5743C2	CARLSTAR	20 X 10.00 - 10	6
TIR94012459	BKT	20 X 10.00 - 10	6
TIRP332221010	CARLSTAR	22 X 10.00 - 10	4
TIRT221110007	OTR	22 X 11.00 - 10	4
TIR574372	CARLSTAR	23 X 8.50 - 12 6	4
TIR574329	CARLSTAR	23 X 9.50 - 12 4	4
TIRP33223105012	WANDA	23 X 10.50 - 12	4
TIR574353	CARLSTAR	23 X 10.50 - 12	6
TIR574338	CARLSTAR	24 X 9.50 - 12	4
TIRP332241212	WANDA	24 X 12.00 - 12	4
TIRT241212004	OTR	24 X 12.00 - 12	4
TIR574352	CARLSTAR	24 X 12.00 - 12	4
TIRT241214002	OTR	24 X 12.00 - 14	4
TIRT251212001	OTR	25 X 12.00 - 12	4
TIR574369	CARLSTAR	25 X 11.00 - 12	4
TIRP332261212	WANDA	26 X 12.00 - 12	4
TIR5743611	CARLSTAR	26 X 12.00 - 12	4
TIR3-50-001-2823	WANDA	26 X 12.00 - 12	4
TIR5743771	CARLSTAR	26 X 12.00 - 12	6
TIRT261412002	OTR	26 X 14.00 - 12	4
TIR5743W7	CARLSTAR	26 X 14.00 - 12	4
TIR574324	CARLSTAR	24 X 8.50 - 14	4
TIRT80424120014	OTR	24 X 12.00 - 14	4
TIR574371	CARLSTAR	25 X 8.50 - 14	6

PART

BRAND

SIZE

PLY

TIR574348	CARLSTAR	27 X 8.50 - 15	4
TIR574356	CARLSTAR	27 X 8.50 - 15	6
TIR5743H6	CARLSTAR	27 X 10.50 - 15	4
TIR560454	CARLSTAR	29 X 12.50 - 15	6
TIR560478	CARLSTAR	29 X 12.50 - 15	10
TIR560362	CARLSTAR	31 X 13.50 - 15	4
TIRT8042612006FP	OTR	26 X 12.00 - 16	4
TIRP3-50-001-9897	WANDA	41 X 14.00 - 20	4
TIR570083	CARLSTAR	41 X 14.00 - 20	4
TIR6A0375	CARLSTAR	44 X 18.00 - 20	6

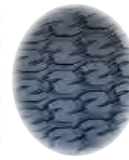

TURF TRAC RS

Turf Trac R/S offers all-around performance with a balanced profile and ample tread depth. Applications include grounds care equipment, zero turn mowers and utility vehicles.

PART

BRAND

SIZE

PLY

TIR5753331	CARLISLE	11X4.00-5	2
TIR5753191	CARLISLE	15X6.00-6	4
TIRDS7055	DEESTONE	15X6.00-6	4
TIR6L02651	CARLISLE	16X6.50-8	4
TIR0864-918	DEESTONE	16X6.50-8	4
TIRDS7060	DEESTONE	18X7.50-8	4
TIR5753311	CARLISLE	18X8.50-8	4
TIRDS7056	DEESTONE	18X8.50-8	4
TIRDS7063	DEESTONE	18X9.50-8	4
TIR5753411	CARLISLE	20X10.00-8	4
TIR940112848	BKT	20X10.00-8	6
TIR0814-918	DEESTONE	20X10.00-8	4
TIR5753B7	CARLISLE	22.5X10.00-8	4
TIR2251055030-4	ACHIEVA	22.5X10.00-8	4
TIR50D3T7	CARLISLE	25X12.00-9	4
TIR251298030-4	ACHIEVA	20X10.00-10	4
TIR50D362	CARLISLE	20X10.00-10	4
TIRDS7067	DEESTONE	20X10.00-10	6
TIR5753151	CARLISLE	20X12.00-10	4
TIR94012855	BKT	20X12.00-10	4
TIR5753N11	CARLISLE	22X9.50-10	4
TIR2295108030-4	ACHIEVA	22X9.50-10	4
TIR2251088030-4	ACHIEVA	22.5X10.00-8	4
TIR5753P2	CARLISLE	24X9.50-10	4
TIR5753A61	CARLISLE	24X12.00-10	4



TURF MASTER TIRES



Turf Master professional grade tires feature our most durable compound with deep tread lug profile optimized for stability and traction.

PART #	BRAND	TIRE SIZE	PLY
TIR5112491	CARLSTAR	13X6.50-6	4
TIR5112521	CARLSTAR	15X6.00-6	4
TIR6L03071	CARLSTAR	15X6.50-8	4
TIR5114011	CARLSTAR	16X6.50-8	4
TIR5114021	CARLSTAR	16X7.50-8	4
TIR5114171	CARLSTAR	18X6.50-8	4
TIR5114041	CARLSTAR	18X8.50-8	4
TIR5114131	CARLSTAR	18X9.50-8	4
TIR5114051	CARLSTAR	20X10.00-8	4
TIR5114281	CARLSTAR	20X8.00-10	4
TIR5114161	CARLSTAR	20X10.00-10	4
TIR511257	CARLSTAR	20X12.00-10	4
TIR511256	CARLSTAR	22X10.00-10	4
TIR5112551	CARLSTAR	22X11.00-10	4
TIR511433	CARLSTAR	22X9.50-12	4
TIR511419	CARLSTAR	23X8.50-12	4
TIR2385128031	ACHIEVA	23X8.50-12	6
TIR511406	CARLSTAR	23X9.50-12	4
TIR5114081	CARLSTAR	23X10.50-12	4
TIR23105128031	ACHIEVA	23X10.50-12	6
TIR511434	CARLSTAR	24X9.50-12	4
TIR5114091	CARLSTAR	24X12.00-12	4
TIR2412128031	ACHIEVA	24X12.00-12	6
TIR2612128031	ACHIEVA	26X12.00-12	6

ALL TRAIL II



- Designed specifically for use on hard surface and paved applications.
- Offers a smooth ride, more responsive handling and extra long life on hard surfaces compared to a standard knobby tire.

PART #	BRAND	TIRE SIZE	PLY
TIR55A3N1	CARLSTAR	22X9.50-10	4
TIR55A3P2	CARLSTAR	24X9.50-10	4
TIR55Z3N9	CARLSTAR	24X10.50-10	4
TIR510043	CARLSTAR	20X10.00-8	4
TIR510045	CARLSTAR	20X10.00-10	4
TIR2295108028-4	ACHIEVA	22X9.50-10	4
TIR510044	CARLSTAR	22X10.00-8	4
TIR510016	CARLSTAR	22X11.00-10	4
TIR22110108028-4	ACHIEVA	22X11.00-10	4
TIR2251088028-4	ACHIEVA	22.5X10.00-8	4
TIR511505	CARLSTAR	23X8.00-12	4
TIR23105128028-4	ACHIEVA	23X10.50-12	4
TIR511505	CARLSTAR	23X10.50-12	4
TIR24105108028-4	ACHIEVA	24X10.50-10	4
TIR511507	CARLSTAR	25X8.00-12	4
TIR511508	CARLSTAR	25X10.50-12	4

ULTRA TRAC



The Ultra Trac is the right approach for those specialized applications where high flotation is essential. Ultra Trac tires are wide with a flat footprint and reduced void in the tread. These features yield low ground pressure and good traction while preserving the turf.

PART #	BRAND	SIZE	PLY
TIR529368	CARLSTAR	24 X 13.00 - 12	4
TIRP5042241312	WANDA	24 X 13.00 - 12	6
TIR10507128BC1	KENDA	24 X 13.00 - 12	6
TIR529387	CARLSTAR	24 X 13.00 - 12	6
TIRT560626120014	OTR	26 X 12.00 - 14	6
TIRT5604265140012	OTR	26.5 X 14.00 - 12	4
TIR529386	CARLSTAR	26.5 X 14.00 - 12	4
TIRP50422651412	WANDA	26.5 X 14.00 - 12	6
TIR105071263C1	KENDA	26.5 X 14.00 - 12	6
TIR529386	CARLSTAR	26.5 X 14.00 - 12	6
TIRT560429140015	OTR	29 X 14.00 - 15	4
TIRP5042291415	WANDA	29 X 14.00 - 15	6
TIR5293F6	CARLSTAR	29 X 14.00 - 15	6
TIR291415001	OTR	29 X 14.00 - 15	12



AT489 TIRES

- Great shock absorption capabilities.
- Outstanding traction for both 2WD and 4WD applications.

PART #	BRAND	SIZE	PLY
TIR5370461	CARLSTAR	22X10-10	4
TIR5793N1	CARLSTAR	22X9.50-10	4
TIR5893V0	CARLSTAR	22X11-10	4
TIR589326	CARLSTAR	23X8-10	4
TIR589327	CARLSTAR	23X10-10	4
TIR589305	CARLSTAR	24X11-10	4
TIR589308	CARLSTAR	25X11-10	4
TIR589329	CARLSTAR	23X8-12	4
TIR589330	CARLSTAR	23X10-12	4
TIR589337	CARLSTAR	24X8-12	4
TIR589342	CARLSTAR	24X9-12	4
TIR589344	CARLSTAR	24X11-12	4
TIR589335	CARLSTAR	25X10-12	4
TIR589351	CARLSTAR	25X11-12	4
TIR6P0371	CARLSTAR	27X9-12	6
TIR6P0372	CARLSTAR	27X1-12	6



SAWTOOTH

PART #	BRAND	TIRE SIZE	PLY
TIRT1026E	GBC	20.5X8.0-10	6
TIRDS7108	DEESTONE	20.5X8.0-10	6
TIR5193471	CARLSTAR	20.5X8.0-10	6
TIR5193491	CARLSTAR	20.5X8.0-10	8
TIR3-50-001-9830	WANDA	20.5X8.0-10	10
TIRDS7110	DEESTONE	20.5X8.0-10	10
TIR5193501	CARLSTAR	20.5X8.0-10	10
TIRT1222S	GBC	22.5X8.0-12	12
TIR5190011	CARLSTAR	2.80-4	4
TIR3-50-001-9653	WANDA	4.10-4	4
TIRDS7200	DEESTONE	4.10-4	4
TIR5190251	CARLSTAR	4.10-4	2
TIR5190261	CARLSTAR	4.10-4	4
TIR5190301	CARLSTAR	4.10-5	2
TIR5190361	CARLSTAR	4.10-6	4
TIR519067	CARLSTAR	5.30/4.50-6	6
TIR5193171	CARLSTAR	4.80-8	B
TIRDS7251	DEESTONE	4.80-8	6
TIRT0856E	GBC	4.80-8	6
TIR5193181	CARLSTAR	4.80-8	6
TIR5193191	CARLSTAR	5.70-8	4
TIRDS7256	DEESTONE	5.70-8	6
TIR5193201	CARLSTAR	5.70-8	6
TIRDS7257	DEESTONE	5.70-8	8
TIR6H01291	CARLSTAR	4.80-12	4
TIRDS7266	DEESTONE	4.80-12	6
TIR6H01301	CARLSTAR	4.80-12	6
TIR6H01381	CARLSTAR	5.30-12	6
TIRDS7271	DEESTONE	5.30-12	6
TIRDS7272	DEESTONE	5.30-12	8
TIR60106	INDUSTRIAL ALL	6.90-9	10



INDUSTRIAL TRAX TIRES

Designed for hard surface application and strength to hold up under heavy weight.

PART #	BRAND	SIZE	PLY
TIR560445	CARLSTAR	25 X 8.50 - 8	4
TIR560446	CARLSTAR	25 X 10.50 - 12	4
TIR103891200C1	KENDA	20 X 9.00 - 12	6
TIR103891076C1	KENDA	20 X 10.00 - 10	6
TIR599581	CARLSTAR	20 X 10.00 - 10	4



KNOBBY

The Knobby tire offers a unique design available in solid or dimple tread pattern. This tire is ideal for use in bunkers.

PART #	BRAND	SIZE	PLY
TIR31200908	CARLSTAR	18 X 9.50 - 8	2
TIR537050	CARLSTAR	22 X 11 - 8	2
TIR537081	CARLSTAR	25 X 12 - 9	2



226 EQUIPMENT PARTS



GALAXY MIGHTY TOW TS

PART #	BRAND	TIRE SIZE	PLY
TIR485040	GALAXY	16x6.50-8	4
TIR485057	GALAXY	18x10.50-10	4
TIR485047	GALAXY	18x8.50-10	4
TIR485048	GALAXY	18x9.50-8	6
TIR485073	GALAXY	20x10.00-8	4
TIR485074	GALAXY	20x10.00-10	6
TIR485532	GALAXY	22x11.00-10	4
TIR485075	GALAXY	23x10.50-12	6
TIR485076	GALAXY	24x12.00-12	4
TIR485088	GALAXY	26x12.00-12	8



GALAXY MIGHTY MOW TURF TIRES

PART #	BRAND	TIRE SIZE	PLY
TIR135259	GALAXY	10X16.5	8
TIR135266	GALAXY	12X16.5	12
TIR135433	GALAXY	17.5L24	8
TIR135439	GALAXY	19.5L24	12
TIR135249	GALAXY	21.5L16.1	6
TIR135138	GALAXY	27X10.50-15	4
TIR135141	GALAXY	27X8.50-15	6
TIR135845	GALAXY	29X12.50-15	4
TIR135343	GALAXY	41X14.00-20	4
TIR135875	GALAXY	44X18.00-20	4
TIR135223	GALAXY	9.5-16	6



GALAXY TURF SPECIAL

PART #	BRAND	SIZE	PLY
TIR480232	GALAXY	12/L16	
TIR401655	GALAXY	21.5/L16.1H	16
TIR480250	GALAXY	22.5/L16.1C	6
TIR480150	GALAXY	25/10.50L15C	6
TIR480151	GALAXY	27/10.50L15C	6
TIR480158	GALAXY	27/12L15C	6
TIR480243	GALAXY	33/16LL16.1E	10
TIR480247	GALAXY	33/18L16.1E	10
TIR480246	GALAXY	41/18.00L16.1C	6
TIR480373	GALAXY	41/18.00L22.5G	14



GARDEN PRO R3 PRO

PART #	BRAND	SIZE	PLY
TIR579726	GALAXY	125/90R22	8
TIR579728	GALAXY	170/100R38	8
TIR579748	GALAXY	200/60R15	8
TIR579689	GALAXY	200/65R16	8
TIR579746	GALAXY	200/70R16	8
TIR579750	GALAXY	220/55R12	8
TIR579743	GALAXY	220/55R14	8
TIR579751	GALAXY	240/60R12	8
TIR579745	GALAXY	240/70R16	8
TIR579754	GALAXY	260/70R16	8
TIR579755	GALAXY	280/70R16	8
TIR579756	GALAXY	280/70R18	8



STRAIGHT RIB

PART #	BRAND	SIZE	PLY
TIR5181861	CARLSTAR	13 X 6.50 - 6	4
TIRDS7226	DEESTONE	13 X 6.50 - 6	4
TIR5180311	CARLSTAR	15 X 6.00 - 6	4
TIRDS7227	DEESTONE	15 X 6.00 - 6	6
TIRDS7211	DEESTONE	13 X 5.00 - 6	4
TIR5180961	CARLSTAR	16 X 6.50 - 8	4
TIRDS7221	DEESTONE	16 X 6.50 - 8	4
TIR518081	CARLSTAR	18 X 9.50 - 8	4
TIR5181161	CARLSTAR	20 X 10.00 - 10	4
TIR94026128	BKT	20 X 10.00 - 10	4
TIRT23105014002	OTR	23 X 10.50 - 14	4
TIR510363	CARLSTAR	26 X 12.00 - 12	10



HD FIELD TRAX

Features a wide profile providing stability on hard-packed surfaces with its non-directional tread pattern and long-lasting construction. Delivers a smooth and comfortable ride while resisting cut, chips and abrasions.

PART #	BRAND	TIRE SIZE	PLY
TIR5883U1	CARLSTAR	18X8.50-10	4
TIR5883B9	CARLSTAR	22.5X10-8	4
TIR588389	CARLSTAR	22X12-8	4
TIR588394	CARLSTAR	25X13-9	4
TIR560467	CARLSTAR	26X12-12	4

Pricing is subject to change.

SMOOTH



PART #	BRAND	SIZE	PLY
TIR5120081	CARLI	8x3.00-4	4
TIR5120101	CARLI	9x3.50-4	4
TIR5100521	CARLI	11x6.00-5	4
TIR5120211	CARLI	13x5.00-6	4
TIRT5504135006	OTR	13x5.00-6	4
TIR5121861	CARLI	13x6.50-6	4
TIRT13656010	OTR	13x6.50-6	4
TIR94013050	BKT	18x10.50-10	2
TIR586310	CARLI	18x10.50-10	2
TIR6L0149	CARLI	18x10.50-10	4
TIRT550418105010	OTR	18x10.50-8	4
TIRP60718958	WANDA	18x9.50-8	4
TIR1895082886-4	ACHIE	18x9.50-8	4
TIR074040856B1	KENDA	18x9.50-8	4
TIR5109811	CARLI	18x9.50-8	4
TIRT5504189508	OTR	18x9.50-8	4
TIR074040869A1	KENDA	19x10.50-8	2
TIRP607191058	WANDA	19x10.50-8	4
TIR1910582886-4-TL	ACHIE	19x10.50-8	4
TIR586325	CARLI	20x10.00-10	2
TIRT550220100010	OTR	20x10.00-10	2
TIRP607201010	WANDA	20x10.00-10	4
TIR084041077B1	KENDA	20x10.00-10	4

CH-23 DELUXE SYSTEM MANUAL TIRE CHANGER



The CH-22 & CH-23 Manual Tire Changing Station includes:

- CH-22 rim clamp plate – adjustable from 4” to 16.5”, 2 center posts – to accommodate open hub and bearing wheels.
- CH-23 tire changer stand with adjustable bead breaker station and tire tool storage locations.
- Patented CH-4 Mongoose Tire Tool! The CH-4 Mongoose is the best tire tool ever made for changing difficult smaller tires thanks to its revolutionary design
- 2 Center Posts to accommodate multiple types of wheels.
- Floor mat for stability and safety

SHPCH2223

CH-22 MANUAL TIRE CHANGER

- Makes the job easy, fast and economical!
- Everything you need to change small tires and accommodates most wheels including open hub and bearing wheels.
- Includes the patented CH-4 Mongoose Tire Tool!

SHPCH22



Let Par West be your go-to rim and tire assembly supplier for your golf cart fleets! Call us to learn more about our available options.

GOLF CART TIRES & WHEELS

- Assemblies are tires mounted on rims with valve stem and fully inflated ready for use.

PART #	SIZE
NIV10990	WHEEL ONLY - 8 X 7 CENTER - 4 HOLE - WHITE
NIV1608	WHEEL ONLY- 8 X 7 CENTER - 4 HOLE - BEIGE
NIV14546	18 X 8.5-8 KENDA HOLE IN ONE TIRE ONLY
NIV41061	18 X 8.5-8 DURO TIRE ONLY
TIR1454A	KENDA TIRE W/ WHEEL MOUNT - WHITE
TIR4061A	DURO TIRE W/ WHEEL MOUNT - WHITE

KENDA
ROUNDED EDGES
W/ SAWTOOTH TREAD



DURO
SAWTOOTH
TREAD



ADDITIONAL GOLF CART TIRE OPTIONS

PART #	BRAND	SIZE	PLY
TIR5192711	CARLSTAR	18X8.50-8	4
TIR5189761	CARLSTAR	18X8.50-8	4
TIRT0874C	GBC	18.5X8.50-8	6
TIRDS7106	DEESTONE	18.5X8.50-8	6
TIR1885088036-GDRG	ACHIEVA	18X8.50-8	6
TIR5191461	CARLSTAR	205/50-10	4

FULL PALLET DISCOUNTS & FREE FREIGHT ON TIRES OR ASSEMBLIES

PORTABLE AIR TANKS



SHPAT5 5 GALLON
SHPAT11 11 GALLON

TIRE INFLATOR



SHPTI

TUBELESS TIRE REPAIR KIT



- 1 X T-handle Spiral Probe Tool 1 X T-handle Insert Tool
- 1 X Tire Pressure Gauge, 40 X Self-Vulcanization Repair Plugs
- 4 X Black Extension Valves, 4 X Chrome Hex Valve Caps
- 4 X Plastic Valve Caps, 1 X 4-in-1 Valve Core Tool
- 4 X Standard Valve Cores, 1 X Folding Knife
- 1 X Plastic Storage Box, 1 X Blue Storage Case
- 2 X L-type Hex Tools, 1 X Jar of lubricant
- 1 X Pliers, 1 X User Manual

SHPTPK

TIRE CEMENT



SHPTC

TIRE PATCHES



- 56 patches included
- Patches come in various sizes
- Both round and rectangular patches
- Includes two tubes of rubber cement and two metal scuffers

SHPTPP

8" BRASS AIR BLOW GUN



SHPABG8

OSHA APPROVED AIR BLOW GUN



SHPABG18 18"
SHPABG24 24"

AIR BLOW NOZZLE



SHPABN

3 LB. DEAD BLOW Mallet



SHPDBM

2 LB. RUBBER Mallet



SHPRM2

PNEUMATIC GREASE GUN



SHPGGAP

GREASE GUN



SHPGGPG PISTOL GRIP
SHPGGLH LEVER ACTION

HITCH PINS



SHPHP12 1/2" X 4.75"
SHPHP58 5/8" X 4.75"
SHPHP34 3/4" X 4.75"

SPRING LOADED BALL JOINTS

- Use to connect reels or rollers to each other
- Spring loaded quick connect fittings
- Made to exceed oem specifications



SHP99-1460 FEMALE
SHP94-2958 MALE STUD



TRION TURF EQUIPMENT LIFTS

Trion's lift is ideally suited for the maintenance needs of golf course maintenance departments and recreation industry, servicing equipment that is commonly used in professional turf facilities. Optional attachments listed below to make repair jobs even easier.

PRO-M 9200 LIFT

TRI92000 COMPLETE LIFT
CRATING CHARGE

PRO-M WORKSTATION OPTIONS

- TRI8401** TOOL BAR EXTENSIONS (PAIR) REQUIRED TO LIFT AUTOMOBILES AND PICK UP TRUCKS
- TRI9104** INTERNATIONAL 220V/50HZ MOTER

UNIVERSIAL ATTACHMENT & ADAPTERS

For servicing mowing units. These hold units upside down for replacing bedknives. Can be purchased and added later.

MUST ORDER

- TRI8201** UNIVERSAL ATTACHEMENT
- THEN SELECT ONE OR MORE BELOW:
- TRI8211** CUTTING UNITS (JACOBSEN 3810)
- TRI6212** TRIPLEX GREENSGROOMER CUTTING UNITS (JACOBSEN & TORO)
- &
- LIGHTWEIGHT FAIRWAY MOWER CUTTING UNITS (JACOBSEN & TORO)
- TRI8213** LIGHTWEIGHT FAIRWAY MOWER CUTTING UNITS (JACOBSEN & TORO)
- TRI8214** TORO RM5500, 650, & 6700
- TRI8215** TORO FLEX 21

OPTIONAL

- TRI8224** STORAGE STAND (STORES ADAPTERS ON PRO-M WORKSTATION) \$204.50



DL-1300 MOBILE LIFT TABLE LIFT

Battery Not Included - Uses 12-Volt Lawn Mover Battery



TRIDL-1300 MOBILE LIFT STATION
CRATING CHARGE

ACCESSORIES

Convenience items can be purchased and added later

- | | |
|--|---|
| TRI8230 SMALL WHEEL ADAPTERS (PAIR) | TRI8308 OIL DRAIN DOLLY |
| TRI8301 ROLLING SHOP STOOL | TRI8309 HEAVY DUTY VEHICLE STAND |
| TRI8302 SCISSORS JACK | TRI8310 OIL WASTE CAN |
| TRI8304 QUICK OIL DRAIN W/ CASTERS | TRI8311 PISTOL GREASE GUN |
| TRI8305 POWER CORD REEL (115 VOLT) | TRI8312 AIR-OPERATED GREASE GUN |
| TRI8306 FLOURESCENT LIGHT REEL (115 VOLT) | TRI8313 LOW PRESSURE TIRE GAUGE |
| TRI8307 AIR HOSE REEL | TRI8314 WATER HOSE REEL |

230 EQUIPMENT PARTS

REPLACEMENT SEATS

- Universal seats designed to fit most maintenance equipment and mowers
- Multiple bolt patterns allow easy mounting



- 1 SHPRSY** YELLOW UNIVERSAL SEAT
- 2 SHPRSG** GRAY UNIVERSAL SEAT
- 3 SHPRSB** BLACK UNIVERSAL SEAT
- 4 SHPRSY-P** YELLOW UNIVERSAL SEAT - PREMIUM BACK AND ERGONOMIC DESIGN
- 5 SHPRSG-P** GRAY UNIVERSAL SEAT - PREMIUM BACK AND ERGONOMIC DESIGN
- SHPRSGT** GREY TORO HDX WORKMAN ONLY SEAT W/ REAR STEEL BACK SUPPORT (NOT PICTURED ABOVE)

REPLACEMENT SEATS PARTS



- 6 SHPRS-SS** REPLACEMENT SAFETY SWITCH
- 7 SHPRS-RAIL** REPLACEMENT ADJUSTMENT RAILS

SEAT COVERS

Universal Fit

- SHPCY** YELLOW
- SHPCB** BLACK
- SHPCC** CAMO



LED HEADLIGHTS

For Riding Mowers Or Equipment
27 Watt - 12 Volt



- SHPELLED** HEAD LIGHT W/ BRACKET
- SHPELHAR** WIRE HARNESS W/ ON/OFF SWITCH



LED LIGHT BARS

High Lighting Options
9-30 Volt



- SHPELBAR12** 12" STRAIGHT LIGHT BAR (72-WATT)
- SHPELBAR20** 20" STRAIGHT LIGHT BAR (126 WATT)
- SHPELBAR32** 32" STRAIGHT LIGHT BAR (180 WATT)
- SHPELBAR42** 42" CURVED LIGHT BAR (240 WATT)
- SHPELHAR** WIRE HARNESS KIT W/ ON/OFF SWITCH



Pricing is subject to change.

SPILL CONTROL PALLETS



- Osha compliant secondary containment for drums
- Can be moved with forklift

JUS28635 4 DRUM SQUARE

JUS28631 4 DRUM IN LINE

JUS28627 3 DRUM IN LINE

JUS28623 2 DRUM

JUS28688 RAMP

DRUM CRADLE



- Easily move drums or put them in a horizontal position to use drain valve

JUS08800 600 LB. CAPACITY

ACCUTECH JET RINSE NOZZLE



IRR17139 3/4" (FGHT) inlet

TOTE CONTAINMENT



- OSHA compliant secondary containment for totes
- Can be moved with forklift

JUS28674 372 GAL. CAPACITY

DRUM PUMP



- Screws onto any drum
- Pumps fertilizers, chemicals or wetting agents

SHDP55 DRUM PUMP

SPILL CONTROL KIT



- Universal 30 gallon spill kit to ensure fast response
- This spill kit is packed with quality SpillTech products to help you clean up fast and comply with regulations
- Includes a variety of sorbents to handle spills of oils, coolants, solvents or water

SAFSPK30 SHOP SPILL KIT

OILY WASTE BINS



JUS09100 6 GALLON RED

JUS09101 6 GALLON YELLOW

JUS09300 10 GALLON RED

JUS09301 10 GALLON YELLOW

JUS09700 21 GALLON RED

JUS09701 21 GALLON YELLOW

HEAVY DUTY TARP



SHDBC6 \$10.00
6" BUNGEE WITH BALL - PACK OF 10

SHPTHD10X12 9.4' x 11.4'

SHPTHD15X20 14' x 20'

SHPTHD20X30 19' x 29.4'

SHPTHD30X40 28.10' x 39.4'

Pricing is subject to change.

POWERBLAST 3000 ALL-IN-ONE ELECTRIC PRESSURE WASHING UNIT - 110V, 3000 PSI

Includes 50 Ft Hose, Hose Reel, 4 Tips, Foam Cannon, Gun, Lance & 10 Ft Leader Hose



NEW PRODUCT!

This first is a pressure washer/reel combination wall mounted unit that is very unique in the marketplace. I see this as a great item for golf courses in both the cart barn and the maintenance shop. Here are the features:

- 3000 PSI working pressure
- 1.20 GPM flow rate – saves water compared to standard hose with high pressure nozzle
- Industrial motor durable enough for commercial daily use and high longevity
- Comes complete with 50-foot, non-scuffing pressure washer hose that is lightest weight and most flexible in the industry
- Self-contained unit includes mounted pressure washer gun, 4 spray tips, wand, and foam cannon
- 110-volt unit plugs directly into standard outlet for easy use
- Comes complete with leader hose – unit is ready to go out of the box with everything you need



IRRPW-R-50 ALL-IN-ONE ELECTRIC PRESSURE WASHING UNIT

SPRAY R-15 AR STYLE PRESSURE WASHER

- AR style Pressure Washer Handle
- Make Washing fun again!
- Shoulder Stock provides comfort when washing for long periods of time
- Max Pressure 5000PSI / 350 Bar
- Includes: Pressure washer gun, additional orange tip barrel extender, 5 Spray tips, & M22-14mm Adapter
- Compatible with standard 1/4" connectors and foam cannons or Hose Cannon below.



This is a pressure washing gun designed to look like an AR rifle. This is NOT a real AR15 rifle. Please take caution when using. Use in a safe location and handle with care.



WRAR001

HOSE CANNON

Kit Includes Foam Cannon And Trigger Nozzle

- Covers large surfaces in seconds making washing a breeze
- Features a robust plastic reservoir and high quality brass components
- Can be adjusted for vertical and horizontal spray patterns
- Adjustable dilution dial for maximum control over the concentration of your wash
- Simple coupling connection to water supply
- Fits any 5/8" and 3/4" standard garden hose



WRTW0013

MOWER UNDERCARRIAGE PRESSURE WASHER WAND

SHPUCW

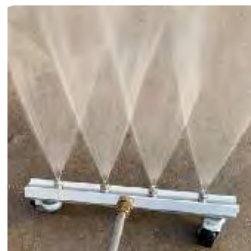

234 MAINTENANCE SHOP SUPPLIES

TURF & LANDSCAPE CANNON KITS

Kit Includes 1 Cannon & 2 Cartridges



- Total wash is the total package when it comes to cleaning and degreasing your equipment
- The non-corrosive formula will quickly remove bugs, brake dust, oil, mud and clay
- Safe to use on soft metals such as aluminum or anodized components
- Total wash is biodegradable and provides a perfect clean without leaving a residue or water spots
- One Cartridge makes 5 gallons of wash
- If not using with a Total Wash Cannon dilute at a 20:1 ratio
- Connects to standard 1/4" pressure washer

WRTW0003 SINGLE KIT

WRTW0003-6 CASE OF 6

TURF & LANDSCAPE CANNON CARTRIDGE



- Total wash is the total package when it comes to cleaning and degreasing your toys
- One bottle makes 5 gallons of wash and can be used with a Total Wash Cannon or diluted with water and applied manually.
- The non-corrosive formula will quickly remove bugs, brake dust, oil, mud and clay
- Biodegradable and safe to use on soft metals such as aluminum or anodized components

WRTW0008 SINGLE CARTRIDGE

WRTW0008-12 CASE OF 12

HEAVY DUTY



- Total wash a strong formula that cuts through oily grime, brake dust, & bug guts with ease.
- Is virtually touchless which means you can throw away your brushes and let the cleaner work for you.
- Easily cleans tires for a deep black finish
- Safe to use on any wheel type
- Great for engine degreasing
- Breaks down bug guts and debris for easy removal
- Acid free

WRTW0015 SINGLE BOTTLE

WRTW0015-16 CASE OF 16

MUD DEFENDER



- Mud release agent that reduces the sticking and clean up of heavy soils, mud, rubber, and clay
- Thick protective coating that leaves a high gloss finish
- Great for use on plastic, metal, rubber, vinyl, and carbon fiber
- Advanced non-silicone technology

WRMD0001 SINGLE CAN

WRMD0001-12 CASE OF 12

F3 - FAST FOAM AIR FILTER CLEANER 320G



- Completely cleans from start to finish quickly!
- Works effectively on Petroleum and Biodegradable filter oils.
- Smells Great, Biodegradable, and Non-flammable
- Self-activating soap when rinsing out in water
- Safe on glue joints and the foam itself
- Doubles as a highly effective air-box cleaner!

WRF30005 SINGLE CAN

WRF30005-12 CASE OF 12

HYDRACOAT QUICK DETAILER



- Gently loosens and lifts dust, pollen, finger prints, and light grime
- Delivers a rich deep lustrous looking finish while achieving a dry anti-static coating
- Cleans shines and Protects all automotive Surfaces
- Hydro Coat technology leaves a long lasting durable hydrophobic coating
- Highly effective for both interior and exterior use

WRHC0001 SINGLE BOTTLE

WRHC0001-16 CASE OF 16

Pricing is subject to change.

TYPE II SAFETY GAS & DIESEL CANS



- | | | | |
|------------|--------------|------------|----------------|
| JUS7210120 | 1 GAL RED | JUS7225120 | 2.5 GAL RED |
| JUS7210220 | 1 GAL YELLOW | JUS7225220 | 2.5 GAL YELLOW |
| JUS7210320 | 1 GAL BLUE | JUS7225320 | 2.5 GAL BLUE |
| JUS7210420 | 1 GAL GREEN | JUS7225420 | 2.5 GAL GREEN |
| JUS7220120 | 2 GAL RED | JUS7250120 | 5 GAL RED |
| JUS7220220 | 2 GAL YELLOW | JUS7250220 | 5 GAL YELLOW |
| JUS7220320 | 2 GAL BLUE | JUS7220320 | 5 GAL BLUE |
| JUS7220420 | 2 GAL GREEN | JUS7220420 | 5 GAL GREEN |



AVOID OSHA FINES
No Plastic Cans

These are "Safety Cans" which are FM approved, UL Listed, CARB & OSHA compliant, and are required by OSHA when used by any business or commercial enterprise. Key required safety features include flame arresters, self-closing lids, pressure relief, and 100% leak testing.

LITHIUM ION BATTERY CHARGING STORAGE CABINET

Call For Pricing

NEW PRODUCTS!

Introducing Justrite's lithium-ion battery charging and storage cabinet, fortified with ChargeGuard™ for ultimate protection. This state-of-the-art cabinet features multiple layers of advanced shielding, specifically designed to reduce the risks of battery fires and thermal runaway.



Charge and store your new Echo eForce Lithium-Ion Batteries!



OUTDOOR SAFETY CABINETS

Call For Pricing



FLAMMABLE MATERIAL STORAGE

30 Gal, 1 Shelf



- 1 shelf, 30 gallon capacity
- Self closing doors
- Meets all OSHA requirements

- JUS893020 YELLOW
- JUS893021 RED

FLAMMABLE MATERIAL STORAGE

90 Gal, 2 Shelf



- 2 shelves, 90 gallon capacity
- Self closing doors
- Meets all OSHA requirements

- JUS899000 YELLOW
- JUS899001 RED

WALL MOUNTED FLAMMABLE CABINET

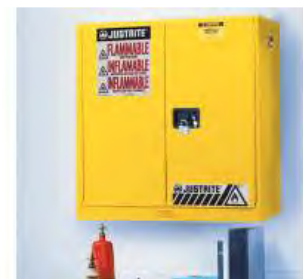

- 3 shelves, 20 gallon capacity
- 2 Self closing doors
- Meets all OSHA requirements

- JUS893400 YELLOW



COMMERCIAL FENCE PRIVACY SCREENING

High-Quality Material Includes Grommets and Fasteners



CLUBHOUSE SERIES SCREEN

DURABLE PRODUCT FOR ATHLETIC FIELDS AND TENNIS COURTS

- 5 Year warranty & 8-10 year expected life
- 95% Privacy with the highest level of uv inhibitors
- 400-Gsm, tight knit woven polypropylene with no fillers for ultimate strength and excellent visibility blockage
- Reinforced edges with black binding & stimpson brass military-grade grommets spaced every 24" on all sides
- Custom sizes, colors and wind holes available by special order

50 Foot Sections - Includes Grommets & Fasteners

PART #	FENCE HEIGHT	COLOR
FS750450-GN	4 FEET	GREEN
FS750550-GN	5 FEET	GREEN
FS750650-GN	6 FEET	GREEN
FS750850-GN	8 FEET	GREEN
FS750450-BK	4 FEET	BLACK
FS750550-BK	5 FEET	BLACK
FS750650-BK	6 FEET	BLACK
FS750850-BK	8 FEET	BLACK

MAINTENANCE SERIES SCREEN

- 90% Privacy & airflow blockage
- Commercial grade material: 175 g/m2 (25% higher than competitors)
- Proprietary heat set process, will not shrink on fence
- Optimum uv additives for weathering protection
- 300-Gsm black binding & solid brass grommets every 24"
- 3 - 5 Year expected life, any climate
- Custom sizes, colors and wind holes available by special order

50 Foot Sections - Includes Grommets & Fasteners

PART #	FENCE HEIGHT	COLOR
FS200450-GN	4 FEET	GREEN
FS200550-GN	5 FEET	GREEN
FS200650-GN	6 FEET	GREEN
FS200850-GN	8 FEET	GREEN
FS200450-BK	4 FEET	BLACK
FS200550-BK	5 FEET	BLACK
FS200650-BK	6 FEET	BLACK
FS200850-BK	8 FEET	BLACK
FS200450-BR	4 FEET	BROWN
FS200550-BR	5 FEET	BROWN
FS200650-BR	6 FEET	BROWN
FS200850-BR	8 FEET	BROWN
FS200450-TAN	4 FEET	DESERT TAN
FS200550-TAN	5 FEET	DESERT TAN
FS200650-TAN	6 FEET	DESERT TAN
FS200850-TAN	8 FEET	DESERT TAN

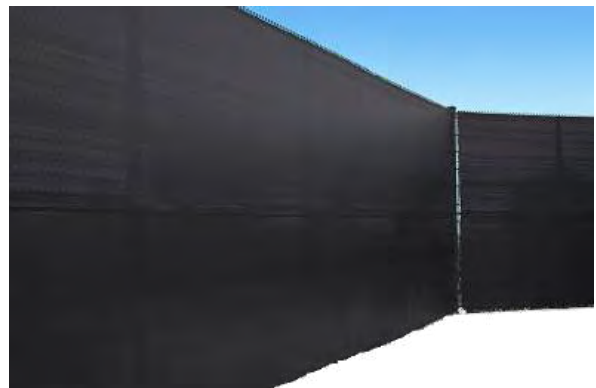

COLOR OPTIONS



Pricing is subject to change.

TERMS & CONDITIONS

PAYMENT METHODS

- Net 30 days - on approved credit
- Payment by mail - We accept Money Orders, Cashier Checks, Company and Personal Checks (allow 7-10 working days for check clearance by Bank). Please make all payment payable to Par West Turf Services and mail payment to:

PAR WEST TURF SERVICES
17952 LYONS CIRCLE
HUNTINGTON BEACH, CA 92647

- Credit card payment - we accept visa, mastercard or American Express payments. If a credit card is used for payment after the due date of an invoice, a 3.5% surcharge will be added.
- Bank wire transfer or paypal - please contact us with questions about these payment methods.

PRICING AND INFORMATION DISCLAIMER

All pricing subject to change without notice. All product measurements are approximate.

PAYMENT TERMS, INTEREST, COLLECTION FEES

Terms of payment are within Par West Turf Services' sole discretion. Invoices are due and payable within the time period noted on the invoice, measured from the date of the invoice. Par West Turf Services Inc. may invoice parts of an order separately. Customer agrees to pay interest on all past due sums at the highest rate allowed by law. The Customer is responsible for sales and all other taxes associated with the order. Any legal costs associated with the collection of invoices will be the responsibility of the customer.

ITEM SPECIFICATIONS

There may be times where Par West Turf Services changes the source of an item for various reasons. Par West Turf Services, at its discretion, reserves the right to substitute an item in the catalog for an equal or better item.

SHIPPING

- Shipping; Title; Risk of Loss. Title to Product and/or Equipment will pass from Par West Turf Services or Par West Turf Services' suppliers to Customer on shipment from Par West Turf Services' facilities or other designated third party supplier's facility. Loss or damage that occurs during shipping by a carrier selected by Par West Turf Services is Par West Turf Services' or Par West Turf Services' supplier's responsibility. Loss or damage that occurs during shipping by a carrier selected by Customer is Customer's responsibility. Par West Turf Services reserves the right to make delivery of Product and/or Equipment in installments.
- In the event the shipment has not been received within 14 days of the billing (hard charge) to the credit card, the customer must contact Par West Turf Services so a tracer can be initiated on the shipment.
- Overnight Shipping. Customers may choose FedEx Standard or Priority Overnight Service or 2 Day for an additional fee.
- International Shipping. Orders outside the USA are subject to import charges, taxes and freight charges which are the responsibility of the purchaser. Contact customer service for more information.
- It is the customer's responsibility to check the packing slip of a shipment and notify Par West of any discrepancy within 5 days of delivery.
- All pricing is f.o.b. shipping point unless otherwise stated.

RETURNS

OUR 30 DAY NO HASSLE RETURN POLICY

- In the event you wish to return an item, please contact us via phone at 714-893-1555, email us at customerservice@parwest.com or through our website to obtain to RMA number to get the return process started.
- Once an RMA number is obtained, if needed we will email you a return label for returned merchandise. Simply hand the UPS or FedEx driver the box with the label attached to it to return the product.
- Credits and/or refunds will be given when the return shipment reaches our warehouse, and we will reach out to you to confirm your return. Only products in unused and non-damaged condition may be returned for credit.
- Please note that for oversized boxes we cannot refund the original shipping costs and you will still need to pay original shipping.
- Returns may be subject to restocking fees and return shipping charges.
- Items received after 30 days are only given account credit with Par West, we cannot refund money on items that are past our 30-day policy.
- All products we sell are covered under their respective manufacturer's warranties. If you feel you have a warranty issue – reach out to us and we will help you work it out with the item's manufacturer.
- Custom orders cannot be returned or refunded. Custom orders require proof approval to ensure item is accurate and approved proof is confirmation of the order.
- Items not returned through our returns policy process above may not be credited to you or may be returned to you.

We Want Every Customer to Have a Positive Experience With Us.

If for Any Reason Your Experience Did Not Meet That Standard, Please Reach Out to Us and We Will do Our Best to Resolve the Issue. We Greatly Appreciate Your Business.

PRODUCT REFERENCE NOTES

**Favorite
Products**

**My Order
Numbers**

**Additional
Notes**

PRODUCT REFERENCE NOTES

**Favorite
Products**

**My Order
Numbers**

**Additional
Notes**



PAR WEST

**PAR WEST TURF SERVICES INC.
17952 LYONS CIRCLE
HUNTINGTON BEACH, CA 92647**

**833-232-3365 - TOLL FREE
714-893-1555 - SALES/CUSTOMER SERVICE
714-893-1575 - FAX
SALES@PARWEST.COM**

WWW.PARWEST.COM

